

**FFP15S60S**

**Features**

- High Speed Switching,  $t_{rr} < 35\text{ns}$  @  $I_F = 15\text{A}$
- High Reverse Voltage and High Reliability
- RoHS compliant

**Applications**

- General Purpose
- Switching Mode Power Supply
- Boost Diode in continuous mode power factor corrections
- Power switching circuits

**15A, 600V STEALTH™ II Rectifier**

The FFP15S60S is STEALTH™ II rectifier with soft recovery characteristics. It is silicon nitride passivated ion-implanted epitaxial planar construction.

This device is intended for use as freewheeling of boost diode in switching power supplies and other power switching applications. Their low stored charge and hyperfast soft recovery minimize ringing and electrical noise in many power switching circuits reducing power loss in the switching transistors.



1. Cathode 2. Anode

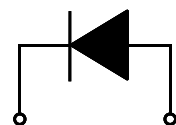

1. Cathode 2. Anode

**Absolute Maximum Ratings**  $T_C = 25^\circ\text{C}$  unless otherwise noted

| Symbol         | Parameter   | Ratings     | Units            |
|----------------|---|-------------|------------------|
| $V_{RRM}$      | Peak Repetitive Reverse Voltage                                 | 600         | V                |
| $V_{RWM}$      | Working Peak Reverse Voltage                                    | 600         | V                |
| $V_R$          | DC Blocking Voltage   | 600         | V                |
| $I_{F(AV)}$    | Average Rectified Forward Current @ $T_C = 123^\circ\text{C}$   | 15          | A                |
| $I_{FSM}$      | Non-repetitive Peak Surge Current<br>60Hz Single Half-Sine Wave | 150         | A                |
| $T_J, T_{STG}$ | Operating and Storage Temperature Range                         | -65 to +150 | $^\circ\text{C}$ |

**Thermal Characteristics**

| Symbol          | Parameter                                    | Ratings | Units              |
|-----------------|--|---------|--------------------|
| $R_{\theta JC}$ | Maximum Thermal Resistance, Junction to Case | 1.3     | $^\circ\text{C/W}$ |

**Package Marking and Ordering Information**

| Device Marking | Device      | Package   | Reel Size | Tape Width | Quantity |
|----------------|-------------|-----------|-----------|------------|----------|
| F15S60S        | FFP15S60STU | TO-220-2L | -         | -          | 50       |

### Electrical Characteristics $T_C = 25^\circ\text{C}$ unless otherwise noted

| Symbol                                       | Parameter  | Min. | Typ.                    | Max.              | Units              |
|--|--|------|-------------------------|-------------------|--------------------|
| $V_{FM1}$                                    | $I_F = 15\text{A}$<br>$I_F = 15\text{A}$                                     | -    | 2.1<br>1.6              | 2.6<br>-          | V                  |
| $I_{RM1}$                                    | $V_R = 600\text{V}$<br>$V_R = 600\text{V}$                                   | -    | -                       | 100<br>500        | $\mu\text{A}$      |
| $t_{rr}$                                     | $I_F = 1\text{A}$ , $di/dt = 100\text{A}/\mu\text{s}$ , $V_R = 30\text{V}$   | -    | 21                      | 30                | ns                 |
| $t_{rr}$<br>$I_{rr}$<br>S factor<br>$Q_{rr}$ | $I_F = 15\text{A}$ , $di/dt = 200\text{A}/\mu\text{s}$ , $V_R = 390\text{V}$ | -    | 23<br>2.5<br>0.7<br>29  | 35<br>-<br>-<br>- | ns<br>A<br>-<br>nC |
| $t_{rr}$<br>$I_{rr}$<br>S factor<br>$Q_{rr}$ | $I_F = 15\text{A}$ , $di/dt = 200\text{A}/\mu\text{s}$ , $V_R = 390\text{V}$ | -    | 55<br>4.3<br>1.1<br>118 | -<br>-<br>-<br>-  | ns<br>A<br>-<br>nC |
| $W_{AVL}$                                    | Avalanche Energy ( $L = 40\text{mH}$ )                                       | 20   | -                       | -                 | mJ                 |

**Notes:**

1: Pulse: Test Pulse width = 300 $\mu\text{s}$ , Duty Cycle = 2%

### Test Circuit and Waveforms

$V_{GE}$  AMPLITUDE AND  
 $R_G$  CONTROL  $di/dt$   
 $t_1$  AND  $t_2$  CONTROL  $I_F$

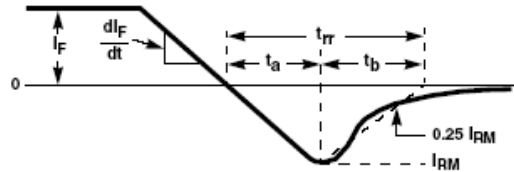
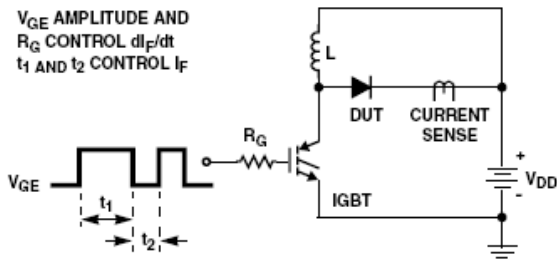

$L = 40\text{mH}$

$R < 0.1\Omega$

$V_{DD} = 50\text{V}$

$E_{AVL} = 1/2 L I^2 [V_{R(AVL)} / (V_{R(AVL)} - V_{DD})]$

$Q1 = \text{IGBT (} BV_{CES} > \text{DUT } V_{R(AVL)} \text{)}$

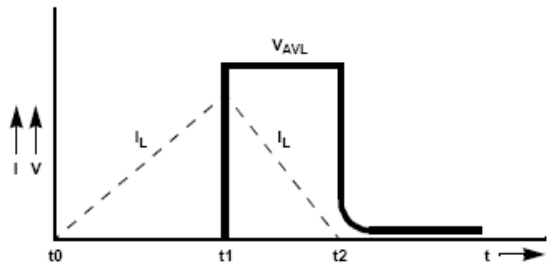
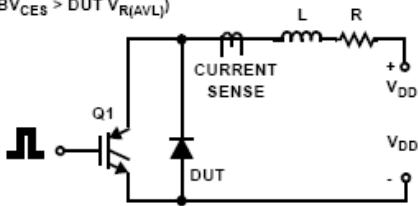

### Typical Performance Characteristics

Figure 1. Typical Forward Voltage Drop vs. Forward Current

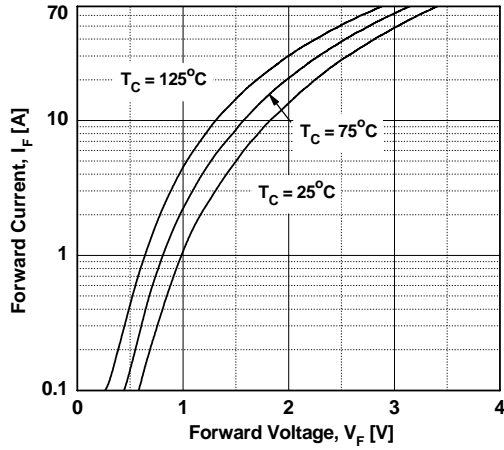

Figure 2. Typical Reverse Current vs. Reverse Voltage

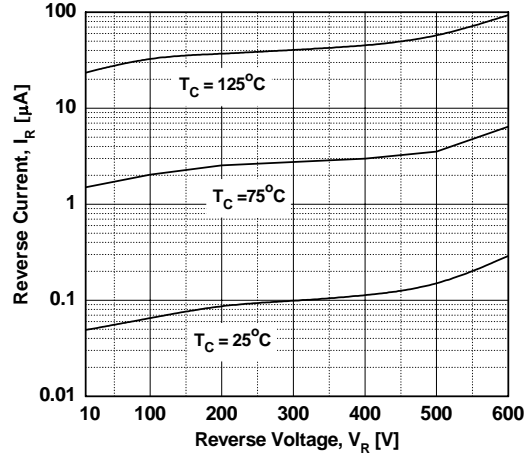

Figure 3. Typical Junction Capacitance

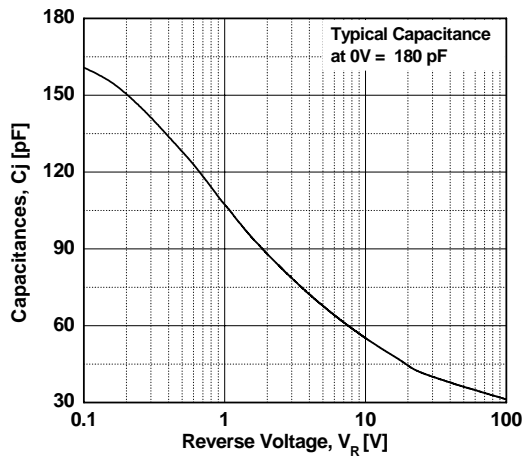

Figure 4. Typical Reverse Recovery Time vs. di/dt

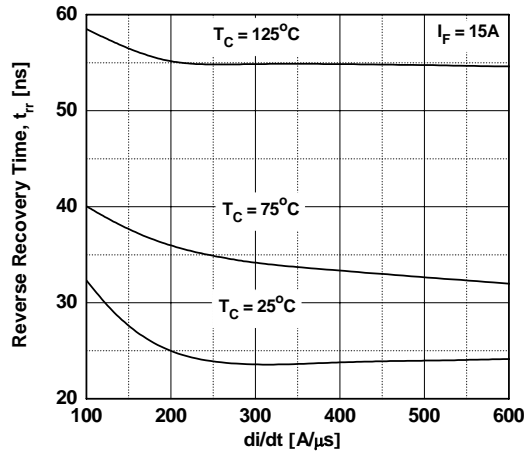

Figure 5. Typical Reverse Recovery Current vs. di/dt

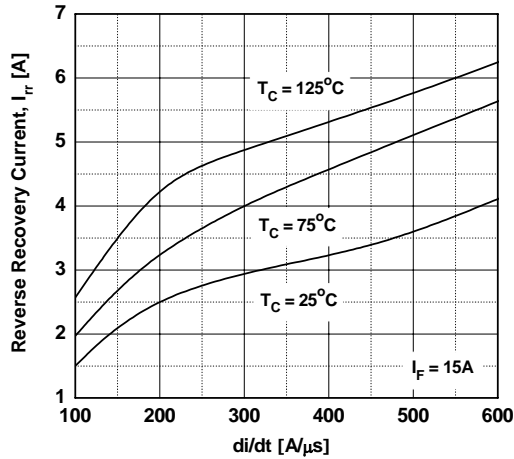
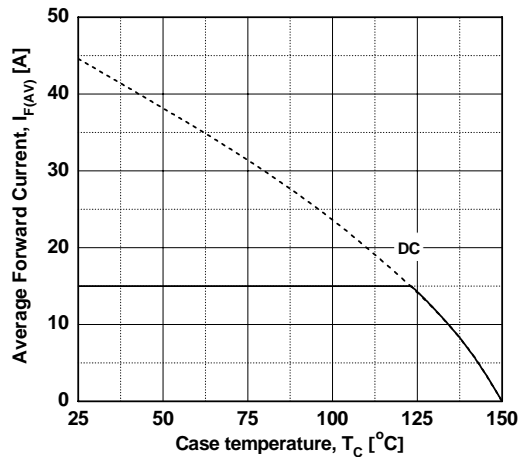
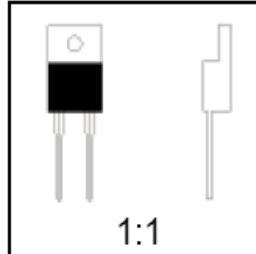

Figure 6. Forward Current Derating Curve



**Mechanical Dimensions**

**TO-220-2L**



Scale 1:1 on letter size paper

Dimensions shown below are in:  
inches [millimeters]

Part Weight per unit (gram): 2.24

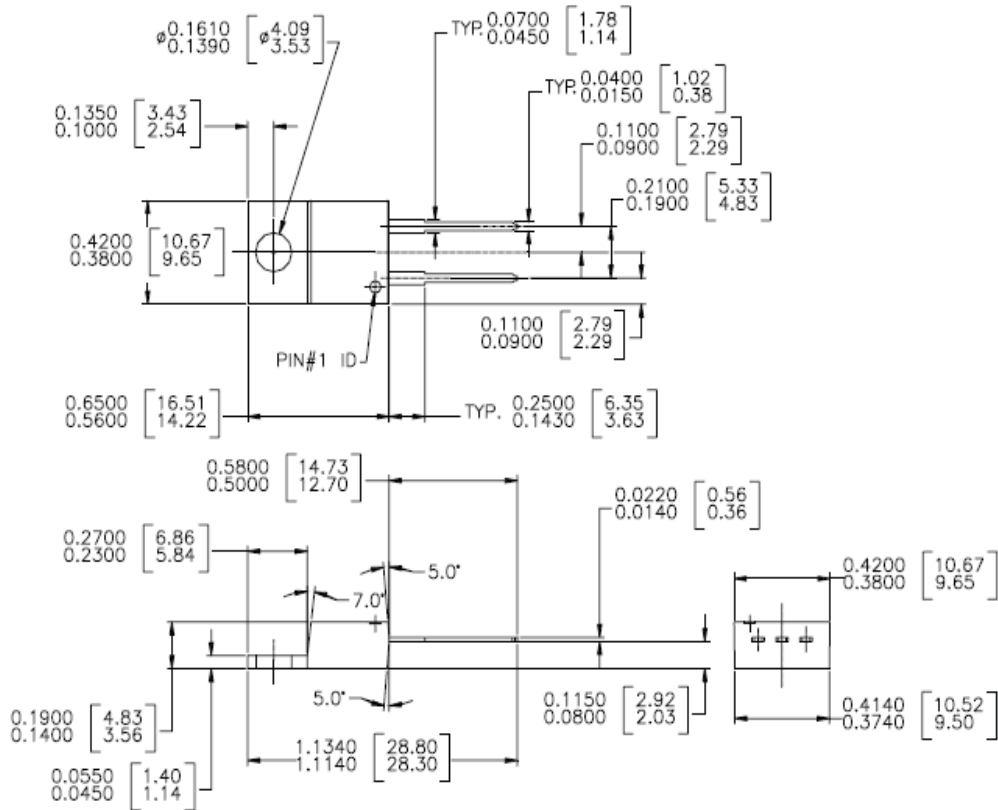

TO 220 2 LEAD

NOTE : UNLESS OTHERWISE SPECIFIED

1. STANDARD LEAD FINISH :  
200 MICROINCHES / 5.08 MICRON MINIMUM  
LEAD / TIN 15/85 ON OLIN 194 COPPER OR EQUIVALENT

2. DIMENSION BASED ON JEDEC STANDARD TO-220  
VARIATION AB, ISSUE J, DATED 3/24/87

Dimensions in Millimeters



**TRADEMARKS**

The following are registered and unregistered trademarks and service marks Fairchild Semiconductor owns or is authorized to use and is not intended to be an exhaustive list of all such trademarks.

- |                                      |  |  |                                  |
|--------------------------------------|--|--|----------------------------------|
| ACEx <sup>®</sup>                    | Green FPS <sup>™</sup>   | Power247 <sup>®</sup>                  | SuperSOT <sup>™</sup> -8         |
| Build it Now <sup>™</sup>            | Green FPS <sup>™</sup> e-Series <sup>™</sup>   | POWEREDGE <sup>®</sup>                 | SyncFET <sup>™</sup>             |
| CorePLUS <sup>™</sup>                | GTO <sup>™</sup>   | Power-SPM <sup>™</sup>                 | The Power Franchise <sup>®</sup> |
| CROSSVOLT <sup>™</sup>               | i-Lo <sup>™</sup>  | PowerTrench <sup>®</sup>               | <b>power</b><br>the franchise    |
| CTL <sup>™</sup>                     | IntelliMAX <sup>™</sup>  | Programmable Active Droop <sup>™</sup> | TinyBoost <sup>™</sup>           |
| Current Transfer Logic <sup>™</sup>  | ISOPLANAR <sup>™</sup>   | QFET <sup>®</sup>                      | TinyBuck <sup>™</sup>            |
| EcoSPARK <sup>®</sup>                | MegaBuck <sup>™</sup>  | QS <sup>™</sup>                        | TinyLogic <sup>®</sup>           |
| <b>F</b> <sup>®</sup>                | MICROCOUPLER <sup>™</sup>  | QT Optoelectronics <sup>™</sup>        | TINYOPTO <sup>™</sup>            |
| Fairchild <sup>®</sup>               | MicroFET <sup>™</sup>  | Quiet Series <sup>™</sup>              | TinyPower <sup>™</sup>           |
| Fairchild Semiconductor <sup>®</sup> | MicroPak <sup>™</sup>  | RapidConfigure <sup>™</sup>            | TinyPWM <sup>™</sup>             |
| FACT Quiet Series <sup>™</sup>       | MillerDrive <sup>™</sup>   | SMART START <sup>™</sup>               | TinyWire <sup>™</sup>            |
| FACT <sup>®</sup>                    | Motion-SPM <sup>™</sup>  | SPM <sup>®</sup>                       | µSerDes <sup>™</sup>             |
| FAST <sup>®</sup>                    | OPTOLOGIC <sup>®</sup>   | STEALTH <sup>™</sup>                   | UHC <sup>®</sup>                 |
| FastvCore <sup>™</sup>               | OPTOPLANAR <sup>®</sup>  | SuperFET <sup>™</sup>                  | UniFET <sup>™</sup>              |
| FPS <sup>™</sup>                     |  <sup>®</sup> | SuperSOT <sup>™</sup> -3               | VCX <sup>™</sup>                 |
| FRFET <sup>®</sup>                   | PDP-SPM <sup>™</sup>   | SuperSOT <sup>™</sup> -6               |                                  |
| Global Power Resource <sup>SM</sup>  | Power220 <sup>®</sup>  |  |                                  |

**DISCLAIMER**

FAIRCHILD SEMICONDUCTOR RESERVES THE RIGHT TO MAKE CHANGES WITHOUT FURTHER NOTICE TO ANY PRODUCTS HEREIN TO IMPROVE RELIABILITY, FUNCTION, OR DESIGN. FAIRCHILD DOES NOT ASSUME ANY LIABILITY ARISING OUT OF THE APPLICATION OR USE OF ANY PRODUCT OR CIRCUIT DESCRIBED HEREIN; NEITHER DOES IT CONVEY ANY LICENSE UNDER ITS PATENT RIGHTS, NOR THE RIGHTS OF OTHERS. THESE SPECIFICATIONS DO NOT EXPAND THE TERMS OF FAIRCHILD'S WORLDWIDE TERMS AND CONDITIONS, SPECIFICALLY THE WARRANTY THEREIN, WHICH COVERS THESE PRODUCTS.

**LIFE SUPPORT POLICY**

FAIRCHILD'S PRODUCTS ARE NOT AUTHORIZED FOR USE AS CRITICAL COMPONENTS IN LIFE SUPPORT DEVICES OR SYSTEMS WITHOUT THE EXPRESS WRITTEN APPROVAL OF FAIRCHILD SEMICONDUCTOR CORPORATION.

As used herein:

- Life support devices or systems are devices or systems which, (a) are intended for surgical implant into the body or (b) support or sustain life, and (c) whose failure to perform when properly used in accordance with instructions for use provided in the labeling, can be reasonably expected to result in a significant injury to the user.
- A critical component in any component of a life support, device, or system whose failure to perform can be reasonably expected to cause the failure of the life support device or system, or to affect its safety or effectiveness.

**PRODUCT STATUS DEFINITIONS**

**Definition of Terms**

| Datasheet Identification | Product Status         | Definition   |
|--------------------------|------------------------|--|
| Advance Information      | Formative or In Design | This datasheet contains the design specifications for product development. Specifications may change in any manner without notice.   |
| Preliminary              | First Production       | This datasheet contains preliminary data; supplementary data will be published at a later date. Fairchild Semiconductor reserves the right to make changes at any time without notice to improve design. |
| No Identification Needed | Full Production        | This datasheet contains final specifications. Fairchild Semiconductor reserves the right to make changes at any time without notice to improve design.   |
| Obsolete                 | Not In Production      | This datasheet contains specifications on a product that has been discontinued by Fairchild Semiconductor. The datasheet is printed for reference information only.                                      |

Rev. I31