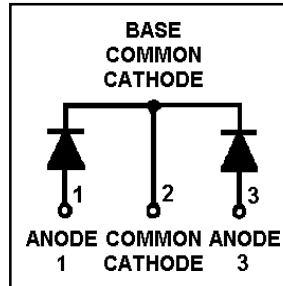


## Features

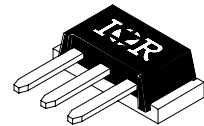
- Reduced RFI and EMI
- Reduced Snubbing
- Extensive Characterization of Recovery Parameters



$V_R = 600V$
$V_F(\text{typ.})^{\textcircled{3}} = 1.2V$
$I_{F(AV)} = 70A$
$Q_{rr}(\text{typ.}) = 210nC$
$I_{RRM}(\text{typ.}) = 6A$
$t_{rr}(\text{typ.}) = 30ns$
$di_{(rec)M}/dt(\text{typ.})^{\textcircled{3}} = 180A/\mu s$

## Description

HEXFRED™ diodes are optimized to reduce losses and EMI/RFI in high frequency power conditioning systems. An extensive characterization of the recovery behavior for different values of current, temperature and  $di/dt$  simplifies the calculations of losses in the operating conditions. The softness of the recovery eliminates the need for a snubber in most applications. These devices are ideally suited for power converters, motors drives and other applications where switching losses are significant portion of the total losses.



SMD-61-8

## Absolute Maximum Ratings (per Leg)

	Parameter	Max.	Units
$V_R$	Cathode-to-Anode Voltage	600	V
$I_F @ T_C = 25^\circ C$	Continuous Forward Current	56	A
$I_F @ T_C = 100^\circ C$	Continuous Forward Current	27	
$I_{FSM}$	Single Pulse Forward Current $\textcircled{1}$	200	
$E_{AS}$	Non-Repetitive Avalanche Energy $\textcircled{2}$	220	$\mu J$
$P_D @ T_C = 25^\circ C$	Maximum Power Dissipation	150	W
$P_D @ T_C = 100^\circ C$	Maximum Power Dissipation	59	
$T_J$	Operating Junction and	-55 to +150	$^\circ C$
$T_{STG}$	Storage Temperature Range		
	Soldering Temperature, for 10 sec.	300 (0.063 in. (1.6mm) from case)	

## Thermal - Mechanical Characteristics

	Parameter	Min.	Typ.	Max.	Units
$R_{thJC}$	Junction-to-Case, Single Leg Conducting	—	—	0.85	$^\circ C/W$
	Junction-to-Case, Both Legs Conducting	—	—	0.42	K/W
Wt	Weight	—	4.3 (0.15)	—	g (oz)

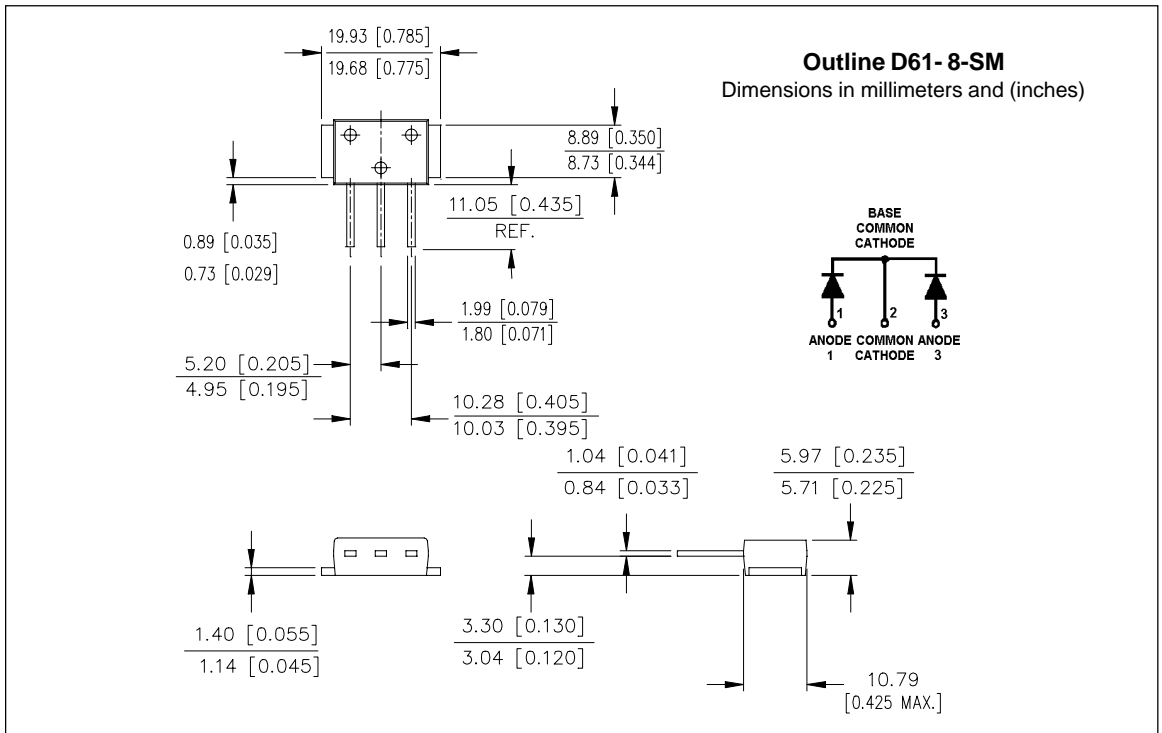
**Note:**  $\textcircled{1}$  Limited by junction temperature  
 $\textcircled{2}$  L = 100 $\mu H$ , duty cycle limited by max  $T_J$   
 $\textcircled{3}$  125 $^\circ C$

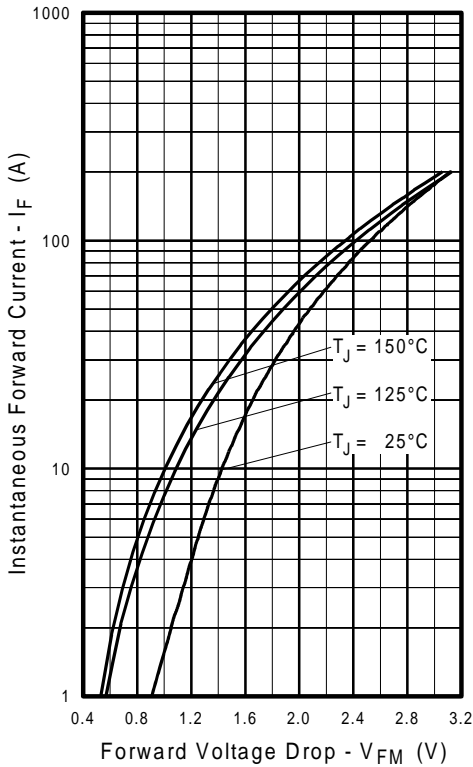
## Electrical Characteristics (per Leg) @ $T_J = 25^\circ\text{C}$ (unless otherwise specified)

Parameter	Min.	Typ.	Max.	Units	Test Conditions	
$V_{BR}$	Cathode Anode Breakdown Voltage	600	—	—	V	$I_R = 100\mu\text{A}$
$V_{FM}$	Max Forward Voltage	—	1.3	1.5	V	$I_F = 35\text{A}$ $I_F = 70\text{A}$ See Fig. 1 $I_F = 35\text{A}, T_J = 125^\circ\text{C}$
		—	1.5	1.7		
		—	1.2	1.4		
$I_{RM}$	Max Reverse Leakage Current	—	2.0	10	$\mu\text{A}$	$V_R = V_R$ Rated See Fig. 2
		—	0.50	2.0	$\text{mA}$	$T_J = 125^\circ\text{C}, V_R = 480\text{V}$
$C_T$	Junction Capacitance	—	68	100	$\text{pF}$	$V_R = 200\text{V}$ See Fig. 3
$L_S$	Series Inductance	—	5.5	—	$\text{nH}$	Lead to lead 5mm from package body

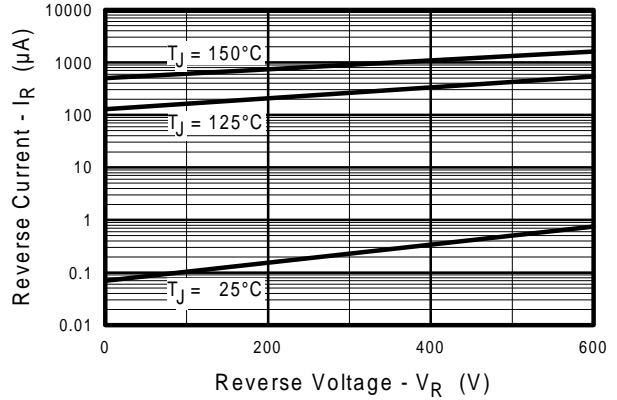
## Dynamic Recovery Characteristics (per Leg) @ $T_J = 25^\circ\text{C}$ (unless otherwise specified)

Parameter	Min.	Typ.	Max.	Units	Test Conditions
$t_{rr}$	Reverse Recovery Time	—	30	—	$I_F = 1.0\text{A}, di/dt = 200\text{A}/\mu\text{s}, V_R = 30\text{V}$
$t_{rr1}$		—	70	ns	$T_J = 25^\circ\text{C}$ See Fig. 5
$t_{rr2}$		—	115		$T_J = 125^\circ\text{C}$
$I_{RRM1}$	Peak Recovery Current	—	6.0	A	$T_J = 25^\circ\text{C}$ See Fig. 6
$I_{RRM2}$		—	9.0		$T_J = 125^\circ\text{C}$
$Q_{rr1}$	Reverse Recovery Charge	—	210	nC	$T_J = 25^\circ\text{C}$ See Fig. 7
$Q_{rr2}$		—	520		$T_J = 125^\circ\text{C}$
$di_{(rec)M}/dt1$	Peak Rate of Fall of Recovery Current During $t_b$	—	280	$\text{A}/\mu\text{s}$	$T_J = 25^\circ\text{C}$ See Fig. 8
$di_{(rec)M}/dt2$		—	180		$T_J = 125^\circ\text{C}$

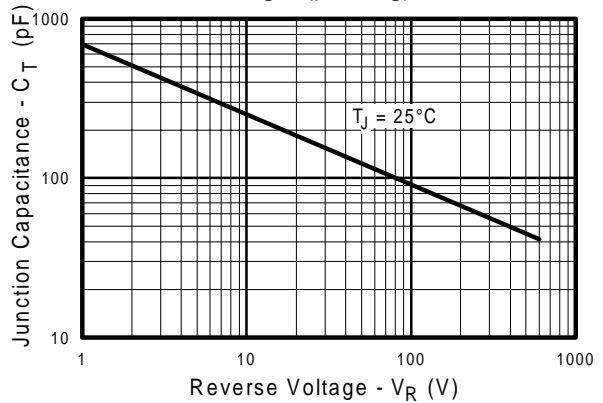




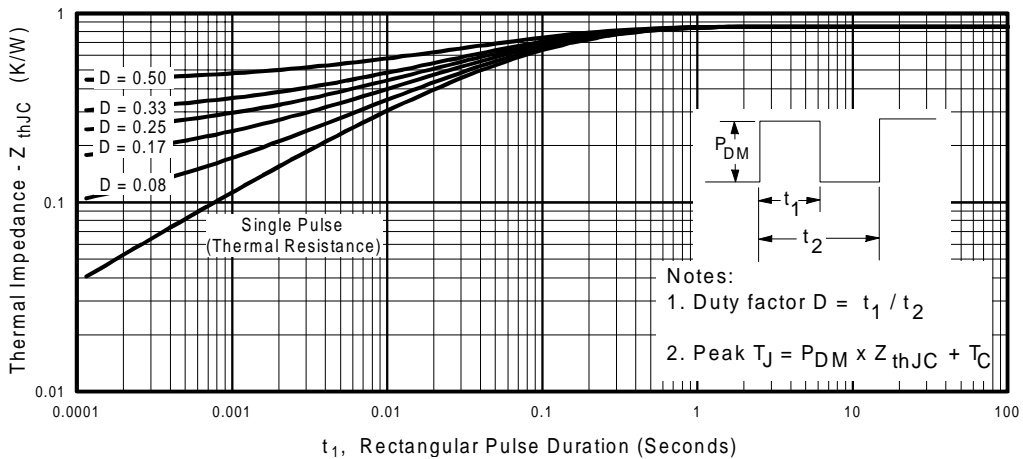
**Fig. 1 - Maximum Forward Voltage Drop vs. Instantaneous Forward Current, (per Leg)**



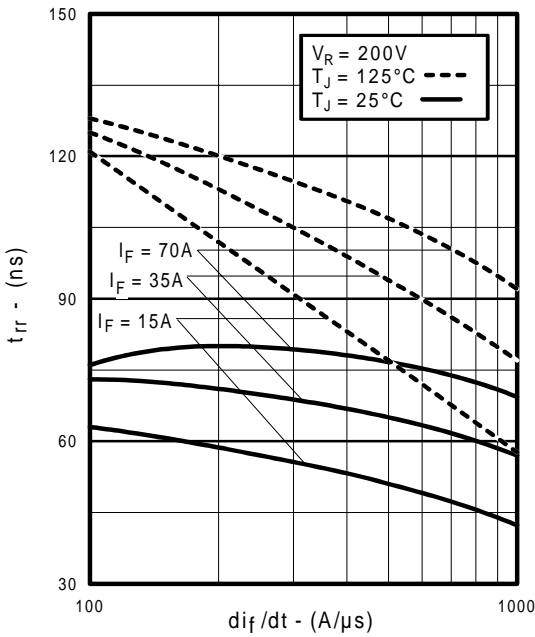
**Fig. 2 - Typical Reverse Current vs. Reverse Voltage, (per Leg)**



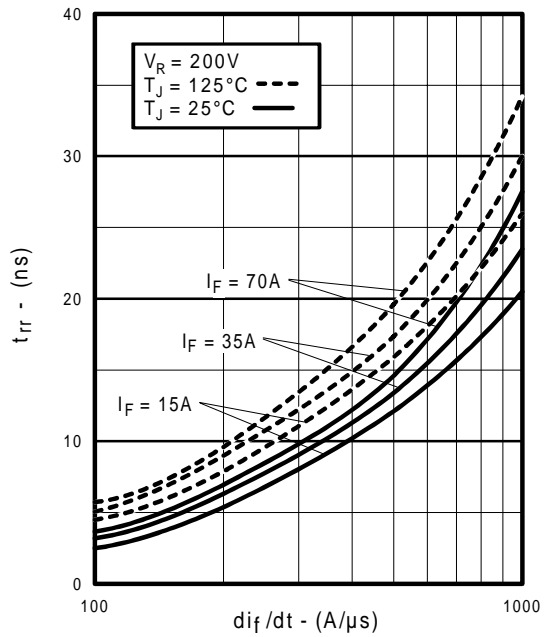
**Fig. 3 - Typical Junction Capacitance vs. Reverse Voltage, (per Leg)**



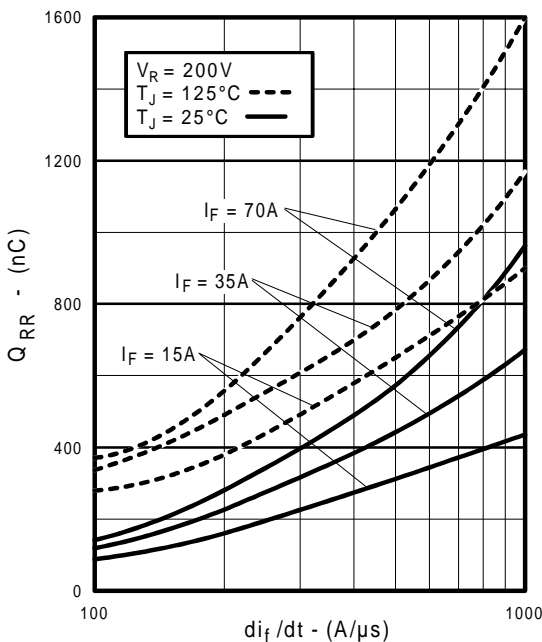
**Fig. 4 - Maximum Thermal Impedance  $Z_{thJC}$  Characteristics, (per Leg)**



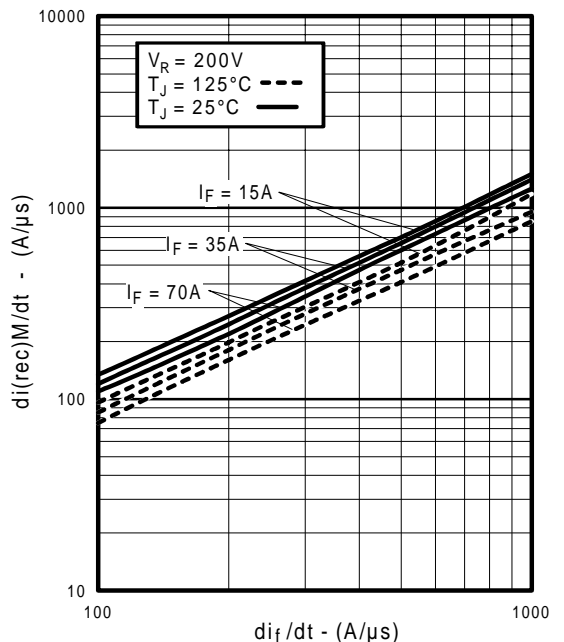
**Fig. 5** - Typical Reverse Recovery vs.  $di_f/dt$ , (per Leg)



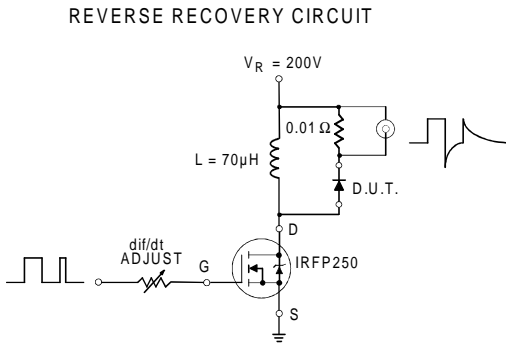
**Fig. 6** - Typical Recovery Current vs.  $di_f/dt$ , (per Leg)



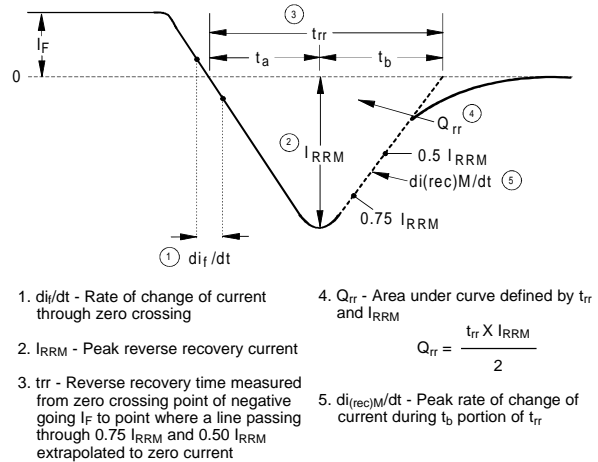
**Fig. 7** - Typical Stored Charge vs.  $di_f/dt$ , (per Leg)



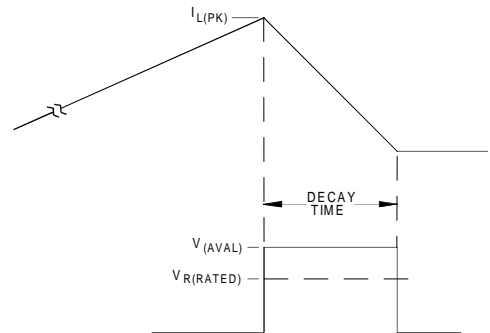
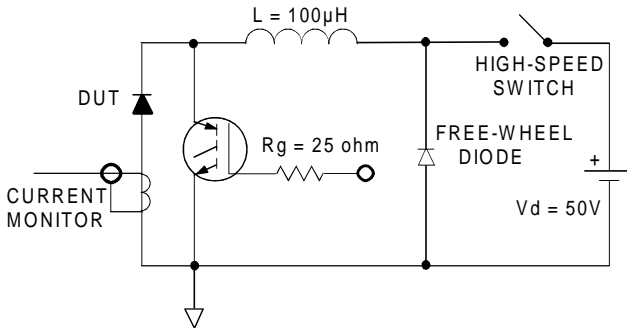
**Fig. 8** - Typical  $di_{(rec)}M/dt$  vs.  $di_f/dt$ , (per Leg)



**Fig. 9** - Reverse Recovery Parameter Test Circuit



**Fig. 10** - Reverse Recovery Waveform and Definitions



**Fig. 11** - Avalanche Test Circuit and Waveforms