

Features

- Fast recovery time characteristics
- Electrically isolated base plate
- Industrial standard package
- Simplified mechanical designs, rapid assembly
- High surge capability
- Large creepage distances
- 3000 V_{RMS} isolating voltage
- UL E78996 approved 

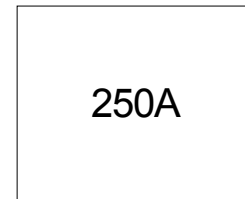

Description

The IRK.L240 Series of MAGN-A-paks uses fast recovery power diodes in four basic configurations. The semiconductors are electrically isolated from the metal base, allowing common heatsinks and compact assemblies to be built. Application includes power supplies, battery chargers, welders, motor controls and general industrial current rectification. These modules are intended for those applications where fast recovery characteristics are required.

Major Ratings and Characteristics

Parameters	IRK.L240		Units
	S10/S20	S30	
$I_{F(AV)}$	250	240	A
@ T_C	100	100	°C
$I_{F(RMS)}$	392	377	A
I_{FSM}			
@ 50Hz	8000	7500	A
@ 60Hz	8400	7850	A
I^2t			
@ 50Hz	322	280	KA ² s
@ 60Hz	294	256	KA ² s
$I^2\sqrt{t}$	3220	2800	KA ² √s
V_{RRM}	up to 2500		V
T_J range	-40 to 150		°C

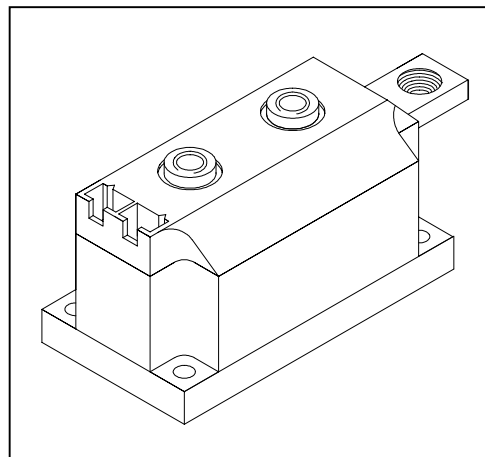

IRK.L240 Series

Bulletin I27094 rev. B 03/01

International
IR Rectifier

ELECTRICAL SPECIFICATIONS

Voltage Ratings

Type number	Voltage Code	t_{rr} Code	V_{RRM} , maximum repetitive peak reverse voltage V	V_{RSM} , maximum non-repetitive peak reverse voltage V	I_{RRM} max. @ 150°C mA
IRK.L240	06	S10	600	700	50
	10	S10	1000	1100	
	12	S20	1200	1300	
	14	S20	1400	1500	
	20	S30	2000	2100	
	25	S30	2500	2600	

Forward Conduction

Parameter		IRK.L240 S10/S20 S30		Units	Conditions		
$I_{F(AV)}$	Max. average forward current @ Case temperature	250	240	A	180° conduction, half sine wave		
		100	100	°C			
$I_{F(RMS)}$	Max. RMS forward current	392	377	A	as AC switch		
I_{FSM}	Max. peak, one-cycle forward, non-repetitive surge current	8000	7500	A	t = 10ms	No voltage	Sinusoidal half wave, Initial $T_J = T_J$ max
		8400	7850		t = 8.3ms	reapplied	
		6750	6300		t = 10ms	100% V_{RRM}	
		7100	6600		t = 8.3ms	reapplied	
I^2t	Maximum I^2t for fusing	322	280	KA ² s	t = 10ms	No voltage	
		294	256		t = 8.3ms	reapplied	
		228	198		t = 10ms	100% V_{RRM}	
		208	181		t = 8.3ms	reapplied	
$I^2\sqrt{t}$	Maximum $I^2\sqrt{t}$ for fusing	3220	2800	KA ² √s	t = 0.1 to 10ms, no voltage reapplied		
$V_{F(TO)1}$	Low level value of threshold voltage	0.98	0.98	V	$(16.7\% \times \pi \times I_{F(AV)} < I < \pi \times I_{F(AV)}) T_J = T_J$ max		
$V_{F(TO)2}$	High level value of threshold voltage	1.31	1.31	V	$(I > \pi \times I_{F(AV)}) T_J = T_J$ max.		
r_{f1}	Low level value of forward slope resistance	0.75	0.97	mΩ	$(16.7\% \times \pi \times I_{F(AV)} < I < \pi \times I_{F(AV)}) T_J = T_J$ max		
r_{f2}	High level value of forward slope resistance	0.41	0.60	mΩ	$(I > \pi \times I_{F(AV)}) T_J = T_J$ max.		
V_{FM}	Max. forward voltage drop	1.57	1.75	V	$I_{FM} = 800, T_J = 150^\circ\text{C}$ tp = 10 ms Av. power = $V_{F(TO)} \times I_{F(AV)} + r_f \times (I_{F(RMS)})^2$		

Blocking

I_{RRM}	Max. peak reverse leakage current	50	mA	$T_J = 150^\circ\text{C}$, leakage current
V_{INS}	RMS isolation voltage	3000	V	50Hz, circuit to base, all terminals shorted, 25°C, t = 1s

Thermal and Mechanical Specifications

T_J	Max. junction operating temperature	-40 to 150	°C	
T_{stg}	Max. storage temperature range	-40 to 150	°C	
R_{thJ-C}	Max. internal thermal resistance junction to case	0.125	K/W	Per junction, DC operation
R_{thC-S}	Thermal resistance, case to heatsink	0.02	K/W	Mounting surface flat, smooth and greased Per module
T	Mounting torque $\pm 10\%$ MAP to heatsink	4 to 6	Nm	A mounting compound is recommended and the torque should be rechecked after a period of about 3 hours to allow for the spread of the compound
		8 to 10	Nm	
wt	Approximate weight	850 (30)	g (oz)	
	Case style	MAGN-A-pak		

DR Conduction (per Junction)

(The following table shows the increment of thermal resistance R_{thJC} when devices operate at different conduction angles than DC)

Conduction angle	Sinusoidal conduction	Rectangular conduction	Units	Conditions
180°	0.008	0.007	K/W	$T_J = T_{J \text{ max.}}$
120°	0.010	0.011	K/W	
90°	0.013	0.015	K/W	
60°	0.019	0.020	K/W	
30°	0.032	0.033	K/W	

Recovery Characteristics

Code	Test conditions			Typ. values @ $T_J = 150^\circ\text{C}$	
	I_{pk} (A)	di/dt (A/ μs)	V_r (V)	Q_{rr} (μC)	I_{rr} (A)
S10	500	100	50	135	100
S20	"	"	"	250	145
S30	"	"	"	360	200

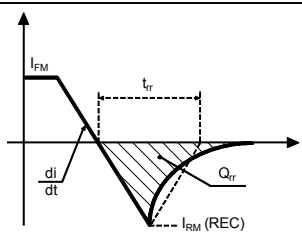

Ordering Information Table

Device Code						
IRK	D	L	240	-	25	S30
①	②	③	④		⑤	⑥
1	- Module type					
2	- Circuit configuration (See Outline Table)					
3	- L = Fast recovery diode					
4	- Current rating					
5	- Voltage code: Code x 100 = VRRM (See Voltage Ratings Table)					
6	- trr code (See Recovery Characteristics Table)					

S10 = 1000 ns
S20 = 2000 ns
S30 = 3000 ns

IRK.L240 Series

Bulletin I27094 rev. B 03/01

Outline Table

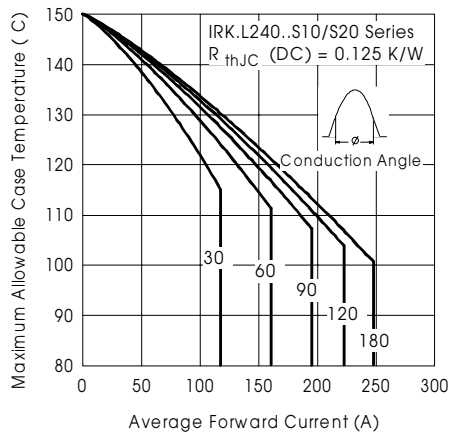
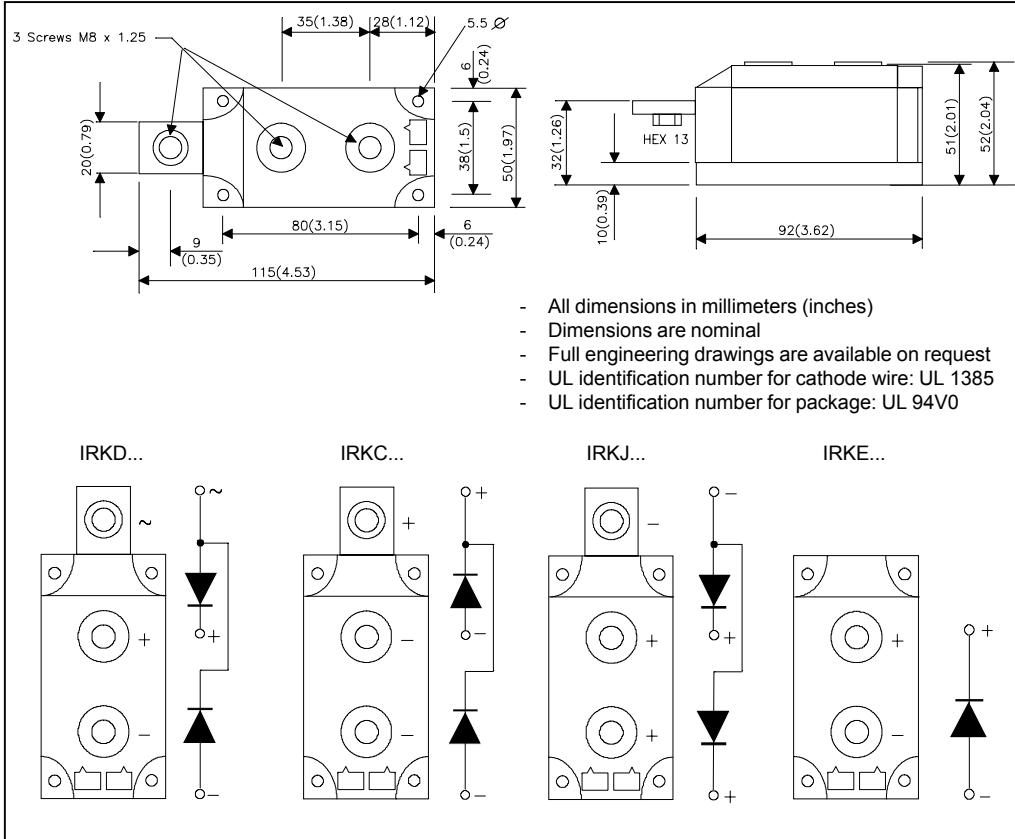

Fig. 1 - Current Ratings Characteristics

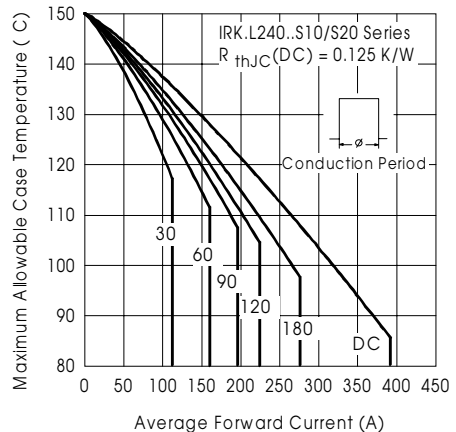

Fig. 2 - Current Ratings Characteristics

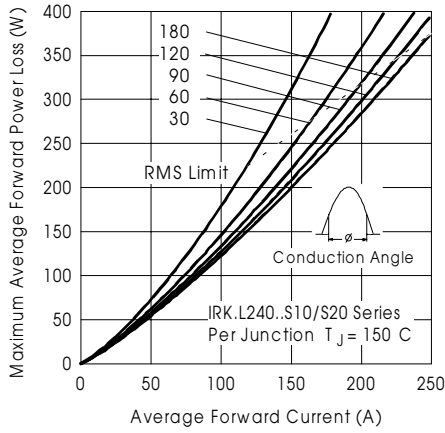

Fig. 3-Forward Power Loss Characteristics

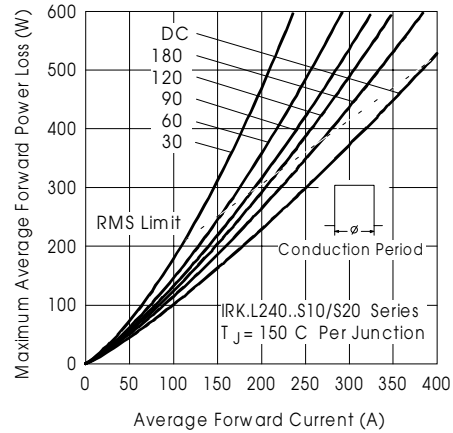

Fig. 4-Forward Power Loss Characteristics

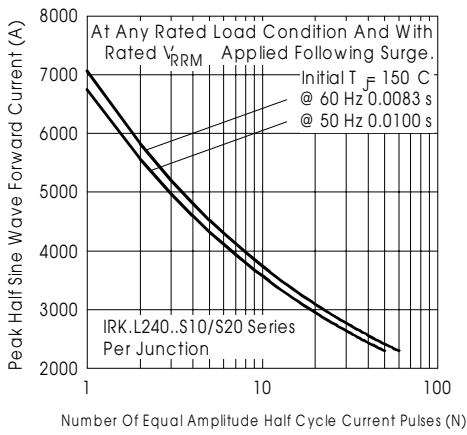

Fig. 5-Maximum Non-Repetitive Surge Current

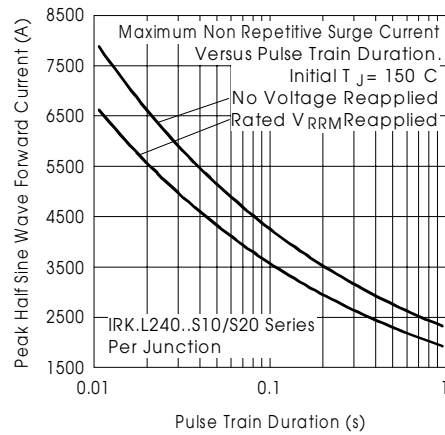

Fig. 6-Maximum Non-Repetitive Surge Current

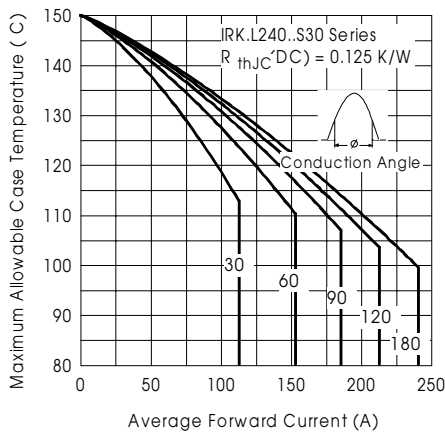

Fig. 7-Current Ratings Characteristics

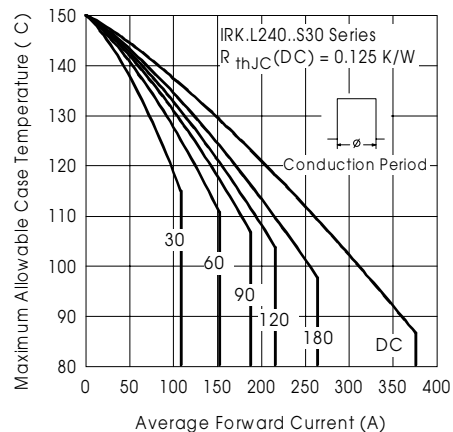

Fig. 8-Current Ratings Characteristics

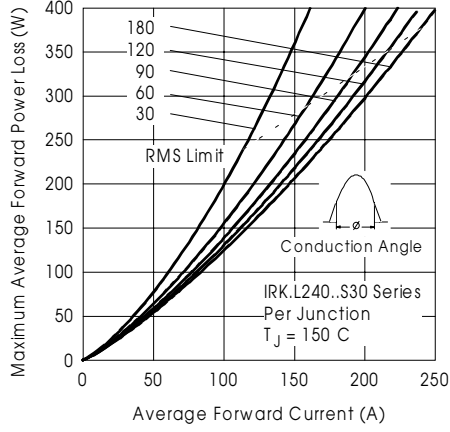

Fig.9-ForwardPowerLossCharacteristics

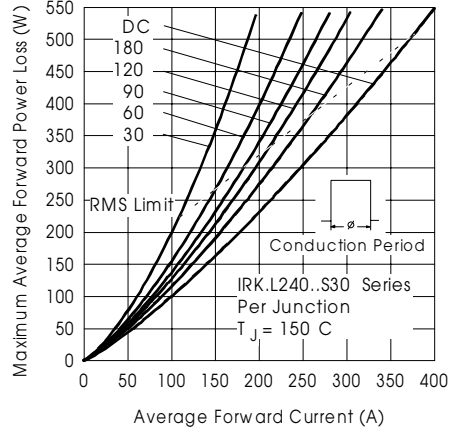

Fig.10-ForwardPowerLossCharacteristics

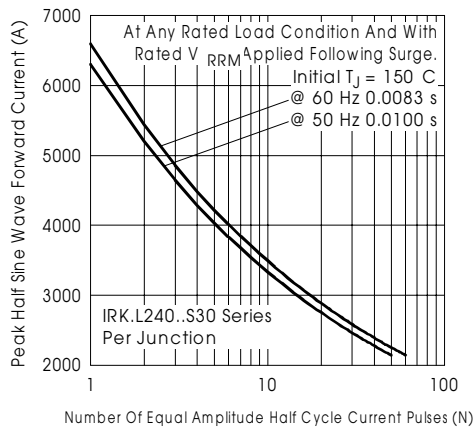

Fig. 11-Maximum Non-Repetitive Surge Current

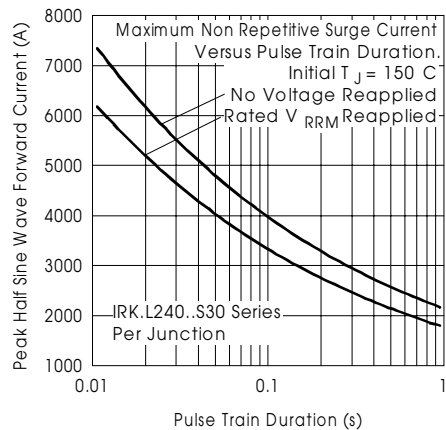

Fig. 12-Maximum Non-Repetitive Surge Current

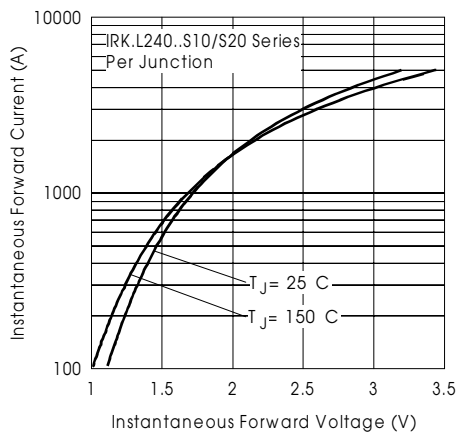

Fig. 13-Forward Voltage Drop Characteristics

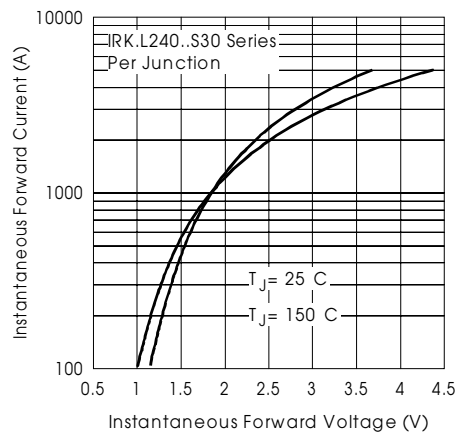

Fig. 14-Forward Voltage Drop Characteristics

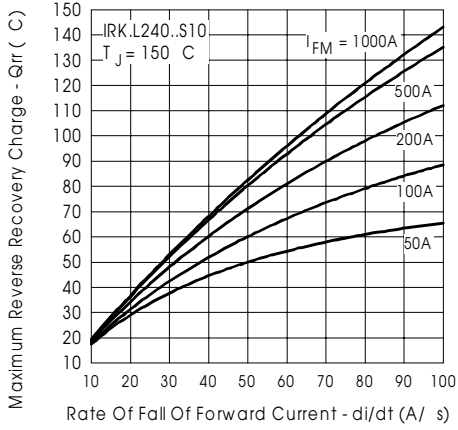

Fig. 15-ReverseRecoveryChargeCharacteristics

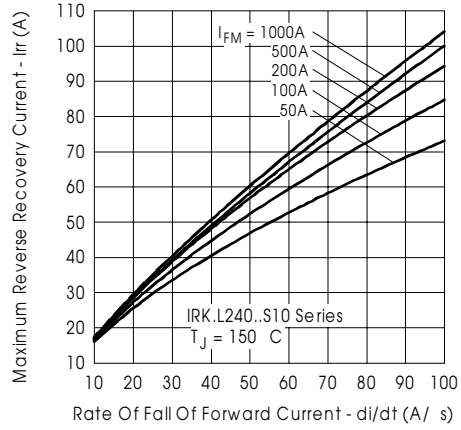

Fig. 16-ReverseRecoveryCurrentCharacteristics

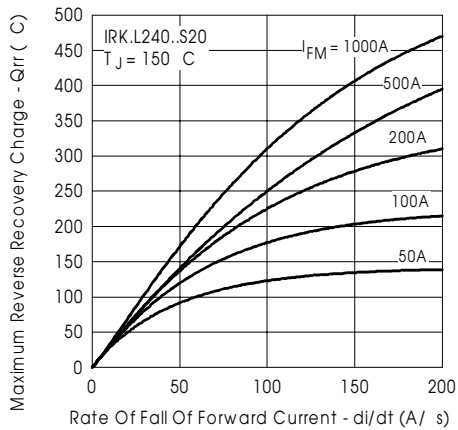

Fig. 17-ReverseRecoveryChargeCharacteristics

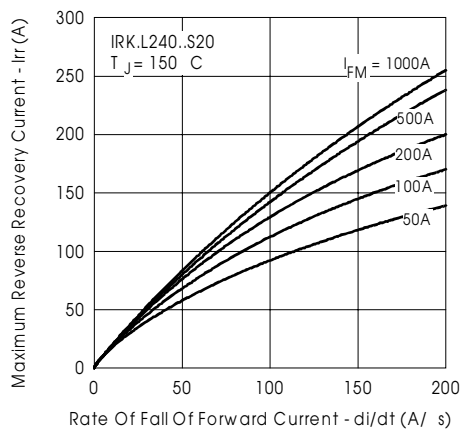

Fig. 18-ReverseRecoveryCurrentCharacteristics

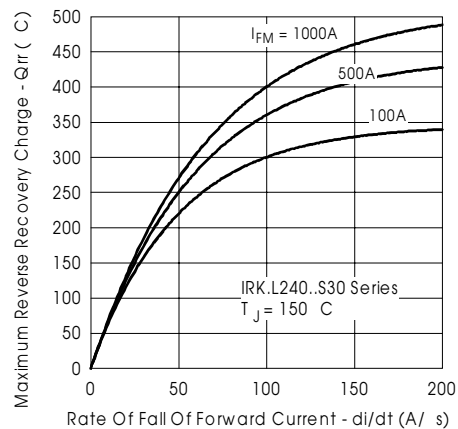

Fig. 19-ReverseRecoveryChargeCharacteristics

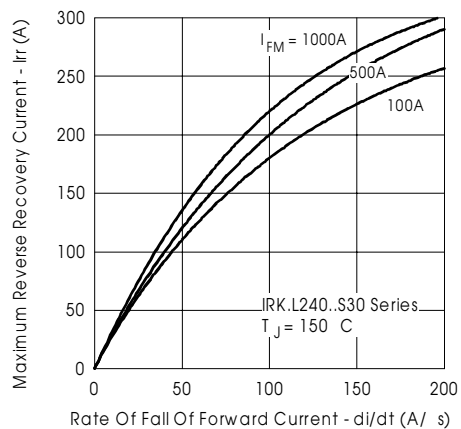

Fig. 20-ReverseRecoveryCurrentCharacteristics

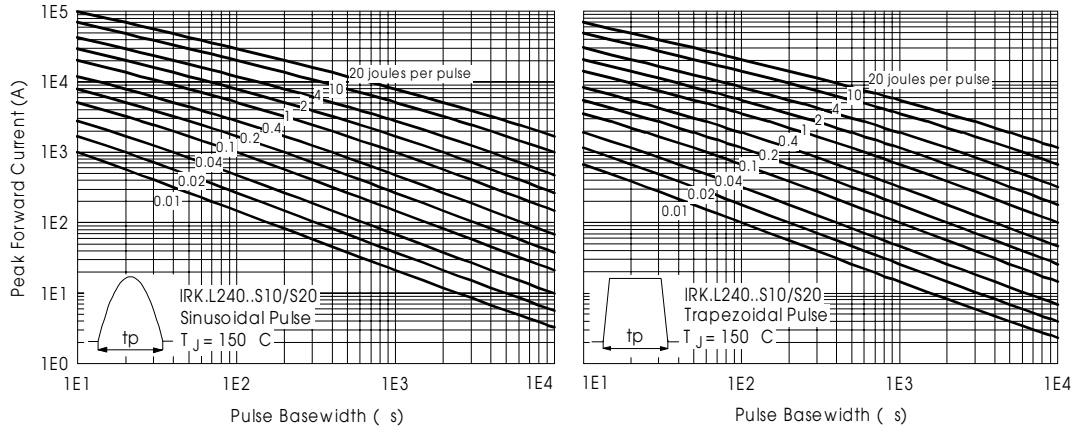

Fig.21-MaximumForwardEnergyPowerLossCharacteristics

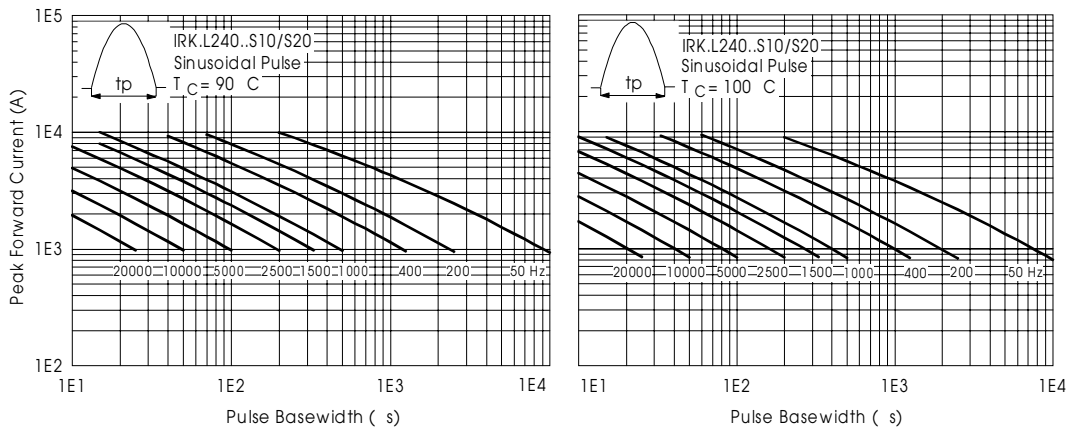

Fig. 22 - Frequency Characteristics

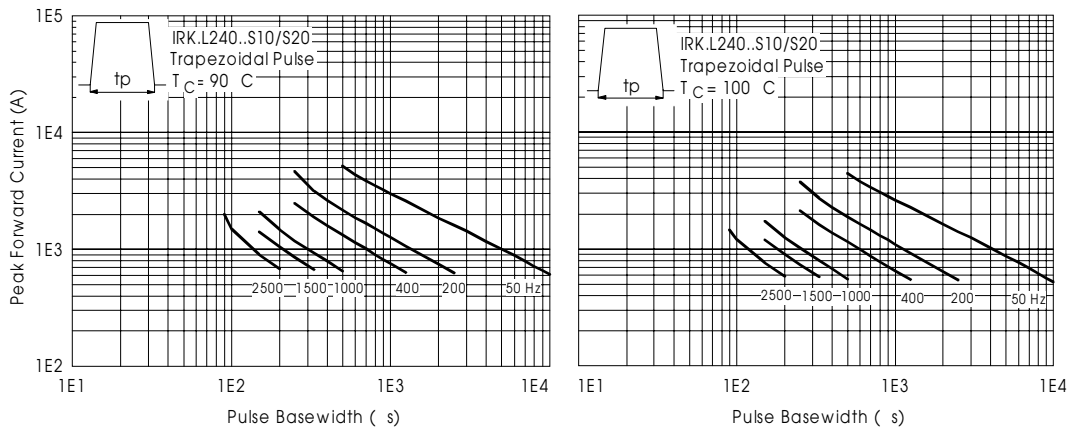

Fig. 23 - Frequency Characteristics

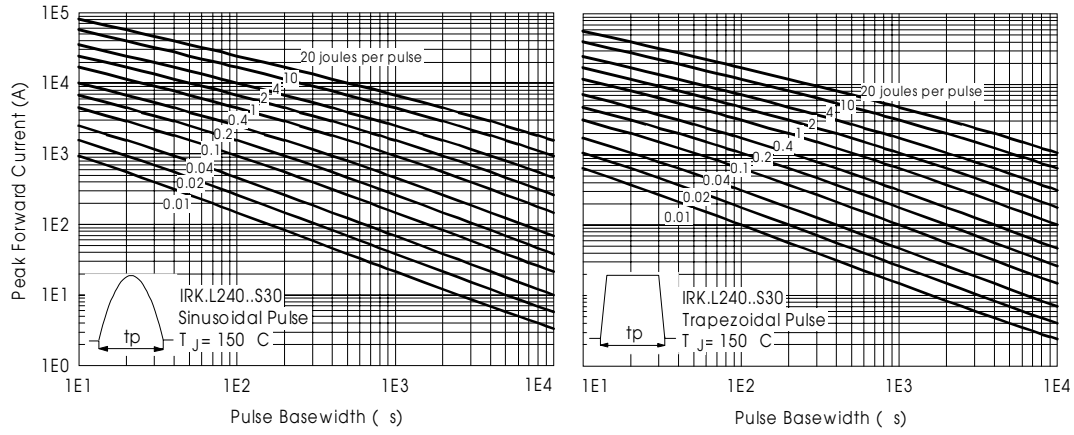

Fig. 24 - Maximum Forward Energy Power Loss Characteristics

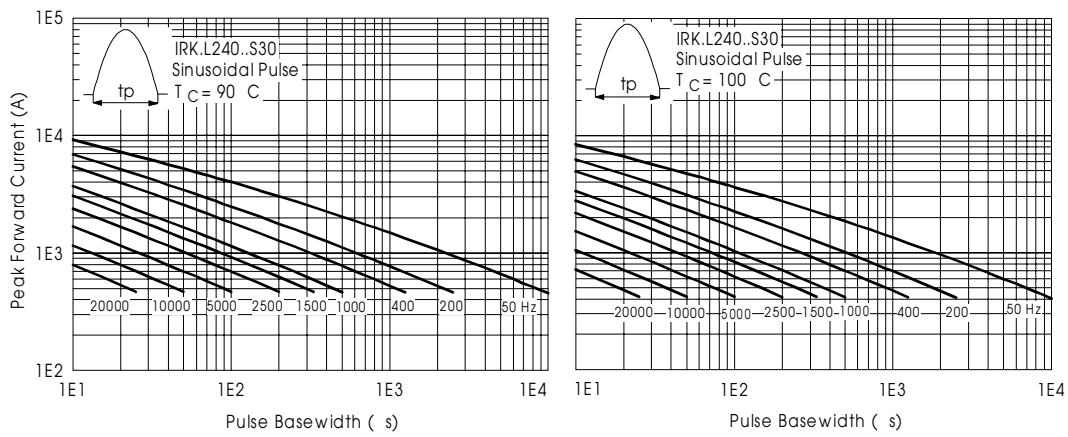

Fig.25-Frequency Characteristics

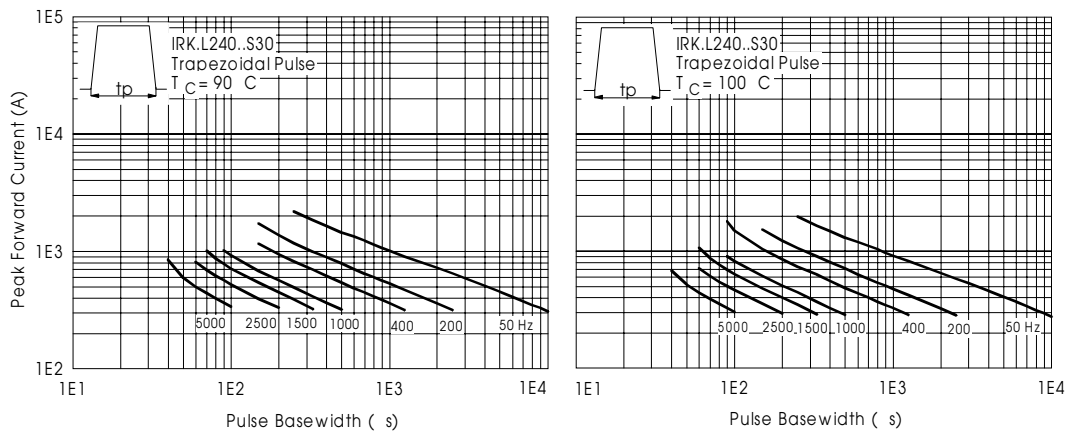

Fig.26-Frequency Characteristics

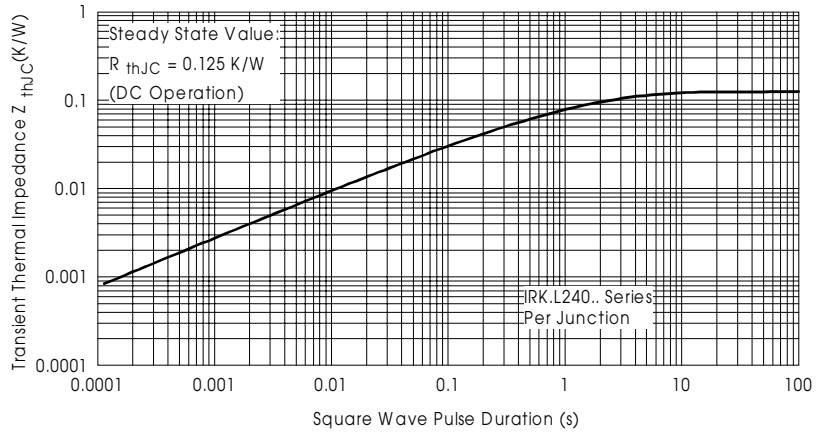

Fig. 27 - Thermal Impedance Z_{thJC} Characteristics