

### STANDARD RECOVERY DIODES

### Hockey Puk Version

#### Features

- Wide current range
- High voltage ratings up to 3200V
- High surge current capabilities
- Diffused junction
- Hockey Puk version
- Case style B-43

#### Typical Applications

- Converters
- Power supplies
- Machine tool controls
- High power drives
- Medium traction applications

1400A

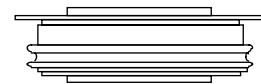

case style B-43

#### Major Ratings and Characteristics

Parameters	SD1100C..C		Units	
	04 to 20	25 to 32		
$I_{F(AV)}$	1400	1100	A	
@ $T_{hs}$	55	55	°C	
$I_{F(RMS)}$	2500	2000	A	
@ $T_{hs}$	25	25	°C	
$I_{FSM}$	@ 50Hz	13000	10500	A
	@ 60Hz	13600	11000	A
$I^2t$	@ 50Hz	846	551	KA <sup>2</sup> s
	@ 60Hz	772	503	KA <sup>2</sup> s
$V_{RRM}$	range	400 to 2000	2500 to 3200	V
$T_J$	range	- 40 to 180	- 40 to 150	°C

## SD1100C..C Series

Bulletin I2072 rev.D 04/00

International  
 Rectifier

### ELECTRICAL SPECIFICATIONS

#### Voltage Ratings

Type number	Voltage Code	$V_{RRM}$ , maximum repetitive peak reverse voltage V	$V_{RSM}$ , maximum non-repetitive peak rev. voltage V	$I_{RRM}$ max. @ $T_J = T_J$ max. mA
SD1100C..C	04	400	500	35
	08	800	900	
	12	1200	1300	
	16	1600	1700	
	20	2000	2100	
	25	2500	2600	
	30	3000	3100	
	32	3200	3300	

#### Forward Conduction

Parameter	SD1100C..C		Units	Conditions		
	04 to 20	25 to 32				
$I_{F(AV)}$ Max. average forward current @ Heatsink temperature	1400(795)	1100(550)	A	180° conduction, half sine wave		
	55(85)	55(85)	°C	Double side (single side) cooled		
$I_{F(RMS)}$ Max. RMS forward current	2500	2000	A	@ 25°C heatsink temperature double side cooled		
$I_{FSM}$ Max. peak, one-cycle forward, non-repetitive surge current	13000	10500	A	t = 10ms	No voltage	Sinusoidal halfwave, Initial $T_J = T_J$ max.
	13600	11000		t = 8.3ms	reapplied	
	10930	8830		t = 10ms	100% $V_{RRM}$	
	11450	9250		t = 8.3ms	reapplied	
$I^2t$ Maximum $I^2t$ for fusing	846	551	KA <sup>2</sup> s	t = 10ms	No voltage	
	772	503		t = 8.3ms	reapplied	
	598	390		t = 10ms	100% $V_{RRM}$	
	546	356		t = 8.3ms	reapplied	
$I^2\sqrt{t}$ Maximum $I^2\sqrt{t}$ for fusing	8460	5510	KA <sup>2</sup> √s	t = 0.1 to 10ms, no voltage reapplied		
$V_{F(TO)1}$ Low level value of threshold voltage	0.78	0.84	V	(16.7% $\times \pi \times I_{F(AV)} < I < \pi \times I_{F(AV)}$ ), $T_J = T_J$ max.		
$V_{F(TO)2}$ High level value of threshold voltage	0.94	0.88		(I > $\pi \times I_{F(AV)}$ ), $T_J = T_J$ max.		
$r_{f1}$ Low level value of forward slope resistance	0.35	0.40	mΩ	(16.7% $\times \pi \times I_{F(AV)} < I < \pi \times I_{F(AV)}$ ), $T_J = T_J$ max.		
$r_{f2}$ High level value of forward slope resistance	0.26	0.38		(I > $\pi \times I_{F(AV)}$ ), $T_J = T_J$ max.		
$V_{FM}$ Max. forward voltage drop	1.31	1.44	V	$I_{pk} = 1500A$ , $T_J = T_J$ max, $t_p = 10ms$ sinusoidal wave		

**Thermal and Mechanical Specifications**

Parameter	SD1100C..C		Units	Conditions
	04 to 20	25 to 32		
T <sub>J</sub> Max. junction operating temperature range	-40 to 180	-40 to 150	°C	
T <sub>stg</sub> Max. storage temperature range	-55 to 200	-55 to 200		
R <sub>thJ-hs</sub> Max. thermal resistance, junction to heatsink	0.076 0.038		K/W	DC operation single side cooled DC operation double side cooled
F Mounting force, ± 10%	9800 (1000)		N (Kg)	
wt Approximate weight	83		g	
Case style	B - 43			See Outline Table

**ΔR<sub>thJ-hs</sub> Conduction**

(The following table shows the increment of thermal resistance R<sub>thJ-hs</sub> when devices operate at different conduction angles than DC)

Conduction angle	Sinusoidal conduction		Rectangular conduction		Units	Conditions
	Single Side	Double Side	Single Side	Double Side		
180°	0.007	0.007	0.005	0.005	K/W	T <sub>J</sub> = T <sub>J</sub> max.
120°	0.008	0.008	0.008	0.008		
90°	0.010	0.010	0.011	0.011		
60°	0.015	0.015	0.016	0.016		
30°	0.026	0.026	0.026	0.026		

**Ordering Information Table**

**Device Code**

SD	110	0	C	32	C
①	②	③	④	⑤	⑥

- 1** - Diode
- 2** - Essential part number
- 3** - 0 = Standard recovery
- 4** - C = Ceramic Puk
- 5** - Voltage code: Code x 100 = V<sub>RRM</sub> (See Voltage Ratings table)
- 6** - C = Puk Case B - 43

# SD1100C..C Series

Bulletin I2072 rev.D 04/00

International  
**IRF** Rectifier

## Outline Table

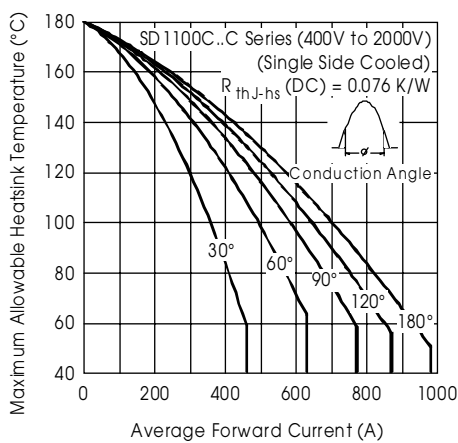
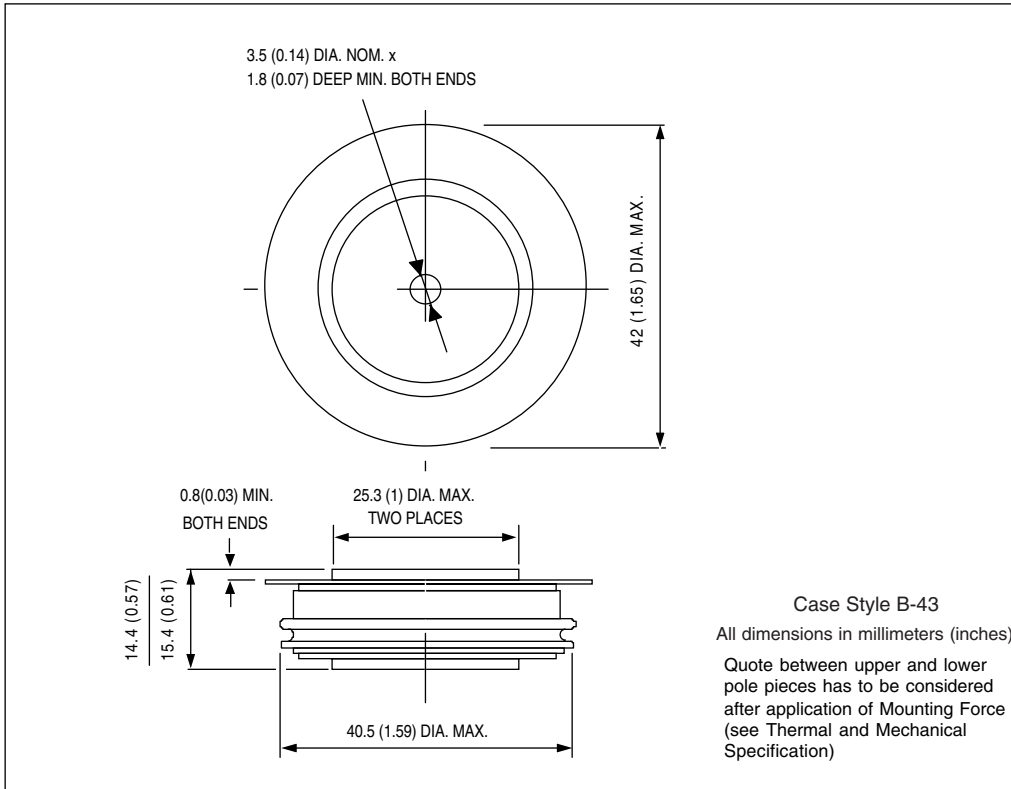

Fig. 1 - Current Ratings Characteristics

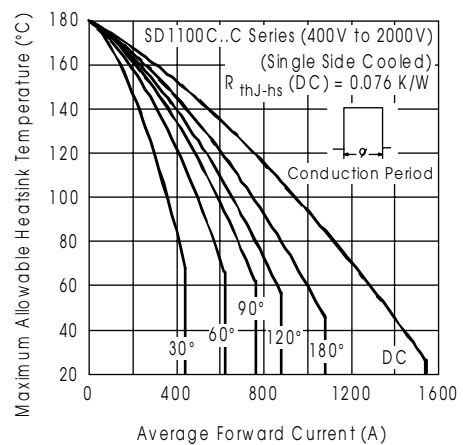

Fig. 2 - Current Ratings Characteristics

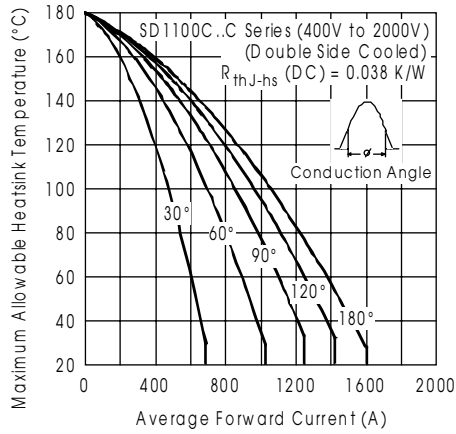

Fig. 3 - Current Ratings Characteristics

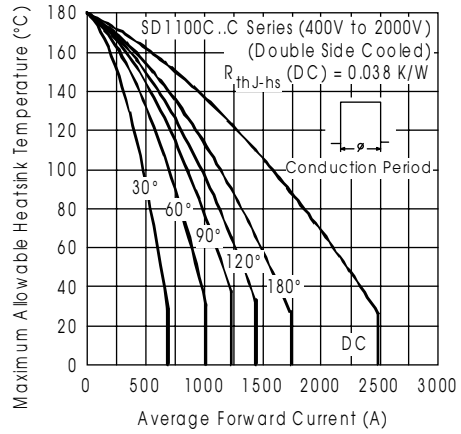

Fig. 4 - Current Ratings Characteristics

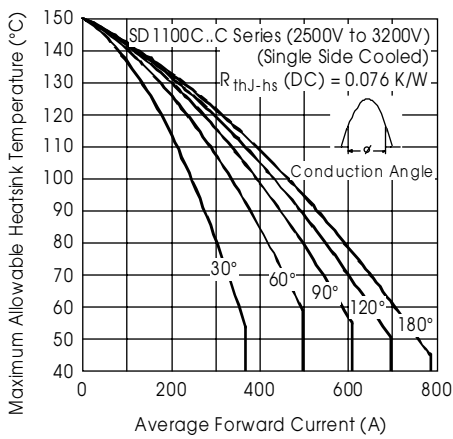

Fig. 5 - Current Ratings Characteristics

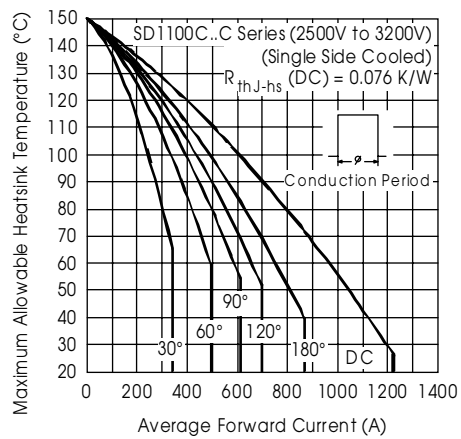

Fig. 6 - Current Ratings Characteristics

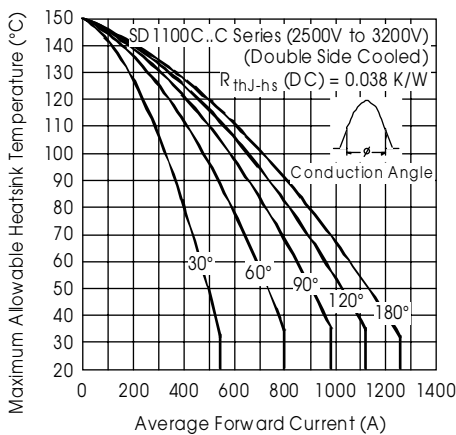

Fig. 7 - Current Ratings Characteristics

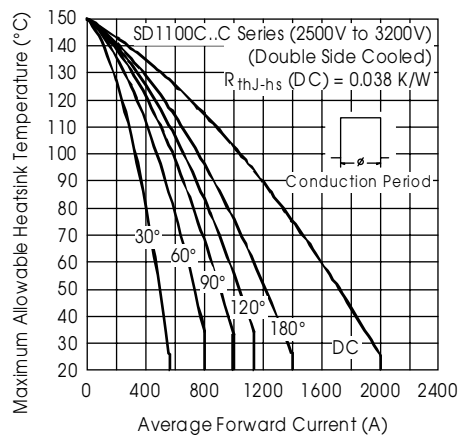

Fig. 8 - Current Ratings Characteristics

# SD1100C..C Series

Bulletin I2072 rev. D 04/00

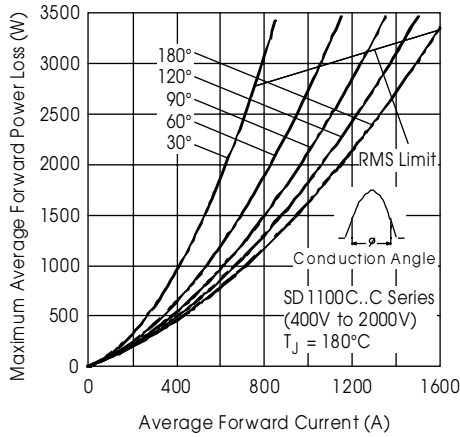

Fig. 9 - Forward Power Loss Characteristics

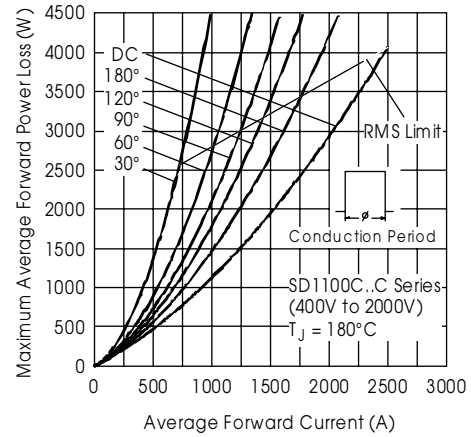

Fig. 10 - Forward Power Loss Characteristics

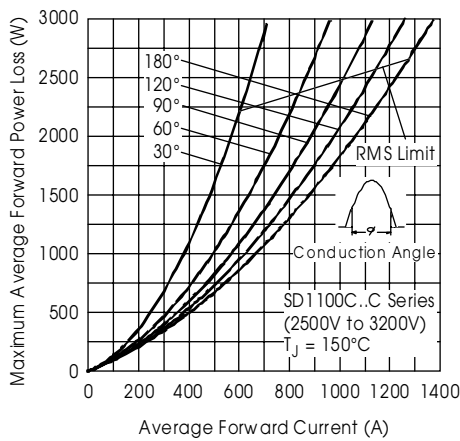

Fig. 11 - Forward Power Loss Characteristics

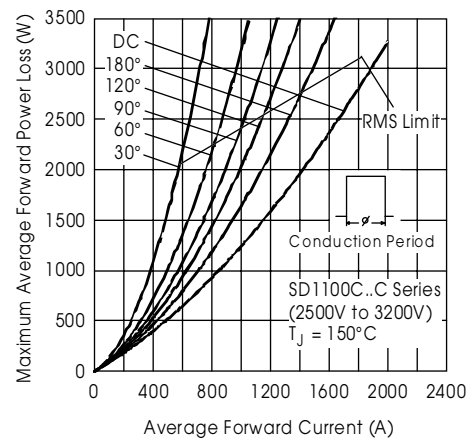

Fig. 12 - Forward Power Loss Characteristics

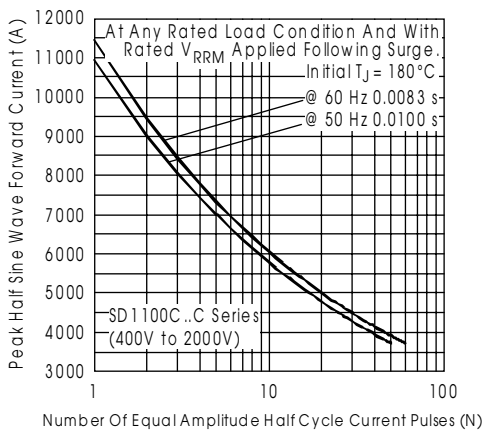

Fig. 13 - Maximum Non-Repetitive Surge Current  
Single and Double Side Cooled

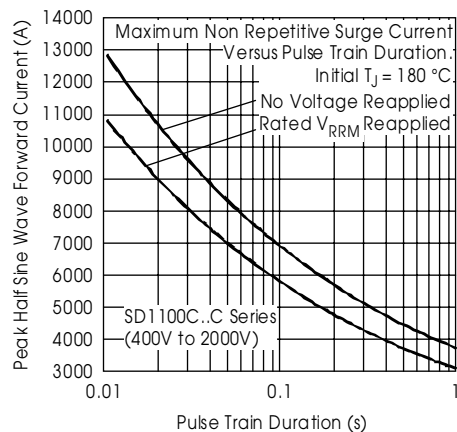

Fig. 14 - Maximum Non-Repetitive Surge Current  
Single and Double Side Cooled

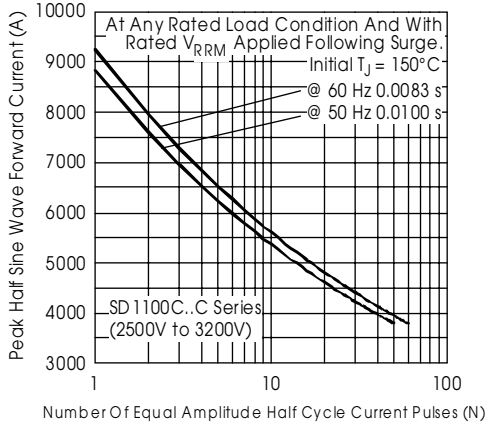

Fig. 15 - Maximum Non-Repetitive Surge Current Single and Double Side Cooled

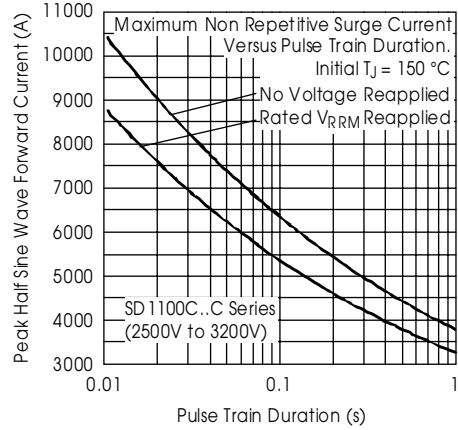

Fig. 16 - Maximum Non-Repetitive Surge Current Single and Double Side Cooled

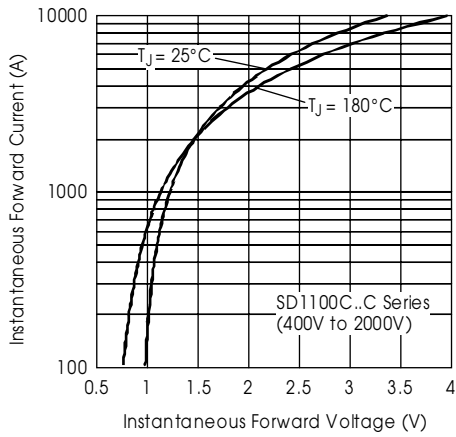

Fig. 17 - Forward Voltage Drop Characteristics

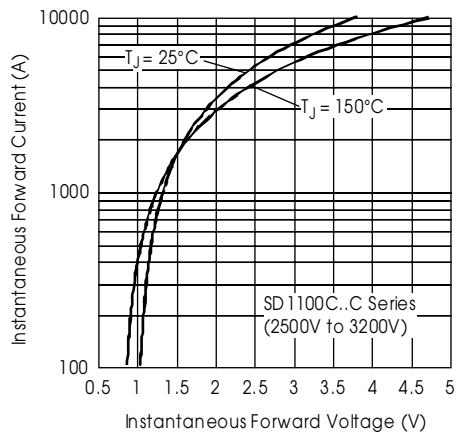

Fig. 18 - Forward Voltage Drop Characteristics

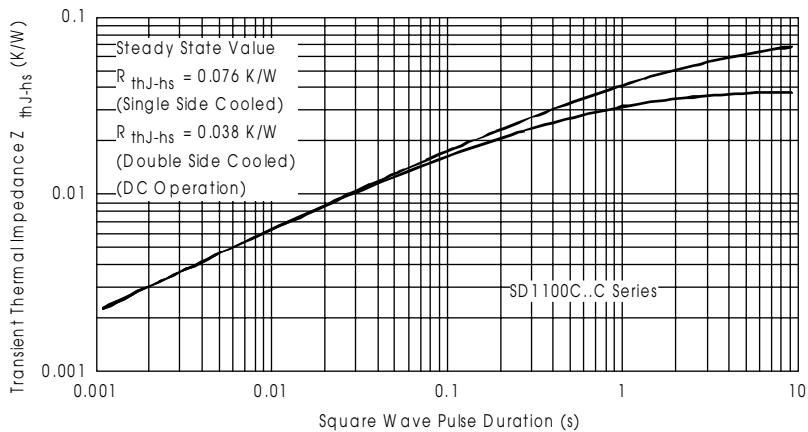

Fig. 19 - Thermal Impedance  $Z_{thJC}$  Characteristics