

GENERAL PURPOSE AMPLIFIERS AND SWITCHES

DESCRIPTION

The 2N2904A, 2N2905A, 2N2906A and 2N2907A are silicon planar epitaxial PNP transistors in Jedec TO-39 (for 2N2904A and 2N2905A) and in Jedec TO-18 (for 2N2906A and 2N2907A) metal cases. They are designed for high-speed saturated switching and general purpose applications.

☰ 2N2904A/2N2905A approved to CECC 50002-100, 2N2906A/2N2907A approved to CECC 50002-103 available on request.

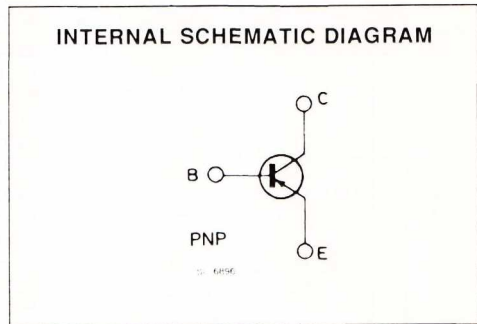
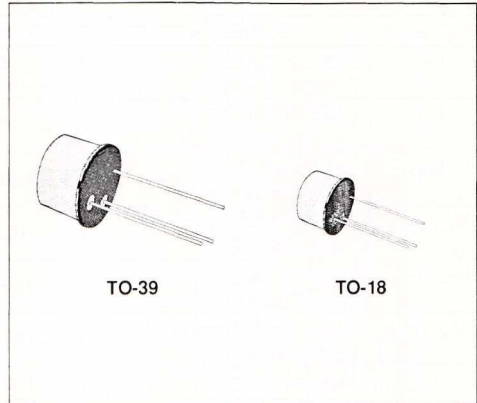

ABSOLUTE MAXIMUM RATINGS

Symbol	Parameter	Value	Unit
V_{CBO}	Collector-base Voltage ($I_E = 0$)	- 60	V
V_{CEO}	Collector-emitter Voltage ($I_B = 0$)	- 60	V
V_{EBO}	Emitter-base Voltage ($I_C = 0$)	- 5	V
I_C	Collector Current	- 600	mA
P_{TOT}	Total Power Dissipation at $T_{amb} \leq 25^\circ\text{C}$		
	for 2N2904A and 2N2905A	0.6	W
	for 2N2906A and 2N2907A	0.4	W
	at $T_{case} \leq 25^\circ\text{C}$		
	for 2N2904A and 2N2905A	3	W
	for 2N2906A and 2N2907A	1.8	W
T_{stg}, T_j	Storage and Junction Temperature	- 65 to 200	$^\circ\text{C}$

THERMAL DATA

			2N2904A 2N2905A	2N2906A 2N2907A
R _{th j-case}	Thermal Resistance Junction-case	Max	58.3 °C/W	97.3 °C/W
R _{th j-amb}	Thermal Resistance Junction-ambient	Max	292 °C/W	437.5 °C/W

ELECTRICAL CHARACTERISTICS (T_{amb} = 25 °C unless otherwise specified)

Symbol	Parameter	Test Conditions	Min.	Typ.	Max.	Unit
I _{CBO}	Collector Cutoff Current (I _E = 0)	V _{CB} = - 50 V V _{CB} = - 50 V T _{amb} = 150 °C			- 10 - 10	nA μA
I _{CEX}	Collector Cutoff Current (V _{BE} = 0.5 V)	V _{CE} = - 30 V			- 50	nA
I _{BEX}	Base Cutoff Current (V _{BE} = 0.5 V)	V _{CE} = - 30 V			- 50	nA
V _{(BR) CBO}	Collector-base Breakdown Voltage (I _E = 0)	I _C = - 10 μA	- 60			V
V _{(BR) CEO} *	Collector-emitter Breakdown Voltage (I _B = 0)	I _C = - 10 mA	- 60			V
V _{(BR) EBO}	Emitter-base Breakdown Voltage (I _C = 0)	I _E = - 10 μA	- 5			V
V _{CE (sat)} *	Collector-emitter Saturation Voltage	I _C = - 150 mA I _B = - 15 mA I _C = - 500 mA I _B = - 50 mA			- 0.4 - 1.6	V V
V _{BE (sat)} *	Base-emitter Saturation Voltage	I _C = - 150 mA I _B = - 16 mA I _C = - 500 mA I _B = - 50 mA			- 1.3 - 2.6	V V
h _{FE} *	DC Current Gain	for 2N2904A and 2N2906A I _C = - 0.1 mA V _{CE} = - 10 V I _C = - 1 mA V _{CE} = - 10 V I _C = - 10 mA V _{CE} = - 10 V I _C = - 150 mA V _{CE} = - 10 V I _C = - 500 mA V _{CE} = - 10 V	40 40 40 40 40		120	
h _{FE} *	DC Current Gain	for 2N2905A and 2N2907A I _C = - 0.1 mA V _{CE} = - 10 V I _C = - 1 mA V _{CE} = - 10 V I _C = - 10 mA V _{CE} = - 10 V I _C = - 150 mA V _{CE} = - 10 V I _C = - 500 mA V _{CE} = - 10 V	75 100 100 100 50		300	
f _T	Transition Frequency	I _C = - 50 mA f = 100 MHz V _{CE} = - 20 V	200			MHz
C _{EBO}	Emitter-base Capacitance	I _C = 0 f = 1 MHz V _{EB} = - 2 V			30	pF
C _{CBO}	Collector-base Capacitance	I _E = 0 f = 1 MHz V _{CB} = - 10 V			8	pF
t _d **	Delay Time	I _C = - 150 mA I _{B1} = - 15 mA V _{CC} = - 30 V			10	ns
t _r **	Rise Time	I _C = - 150 mA I _{B1} = - 15 mA V _{CC} = - 30 V			40	ns
t _s **	Storage Time	I _C = - 150 mA V _{CC} = - 6 V I _{B1} = - I _{B2} = - 15 mA			80	ns

* Pulsed : pulse duration = 300 μs, duty cycle = 1.5 %.

** See test circuit.

ELECTRICAL CHARACTERISTICS (continued)

Symbol	Parameter	Test Conditions	Min.	Typ.	Max.	Unit
t_f **	Fall Time	$I_C = -150 \text{ mA}$ $V_{CC} = -6 \text{ V}$ $I_{B1} = -I_{B2} = -15 \text{ mA}$			30	ns
t_{on} **	Turn-on Time	$I_C = -150 \text{ mA}$ $V_{CC} = -30 \text{ V}$ $I_{B1} = -15 \text{ mA}$			45	ns
t_{off} **	Turn-off Time	$I_C = -150 \text{ mA}$ $V_{CC} = -6 \text{ V}$ $I_{B1} = -I_{B2} = -15 \text{ mA}$			100	ns

* Pulsed : pulse duration = 300 μs , duty cycle = 1.5 %.
** see test circuit.

Normalized DC Current Gain.

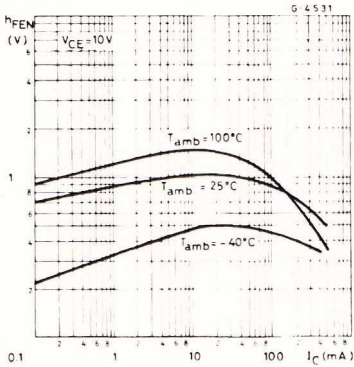

Collector-emitter Saturation Voltage.

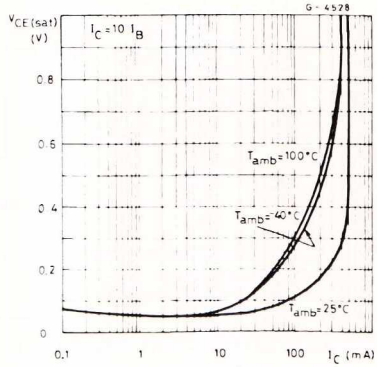

Collector-base and Emitter-base capacitances.

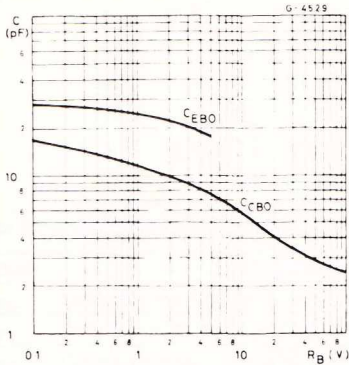

Switching Characteristics.

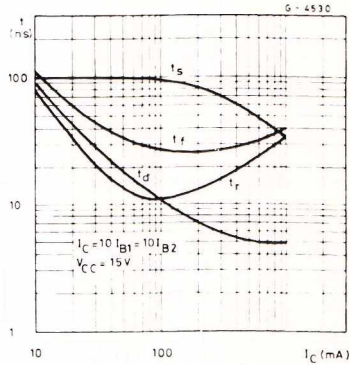

Test Circuit for t_{on} , t_r , t_d .

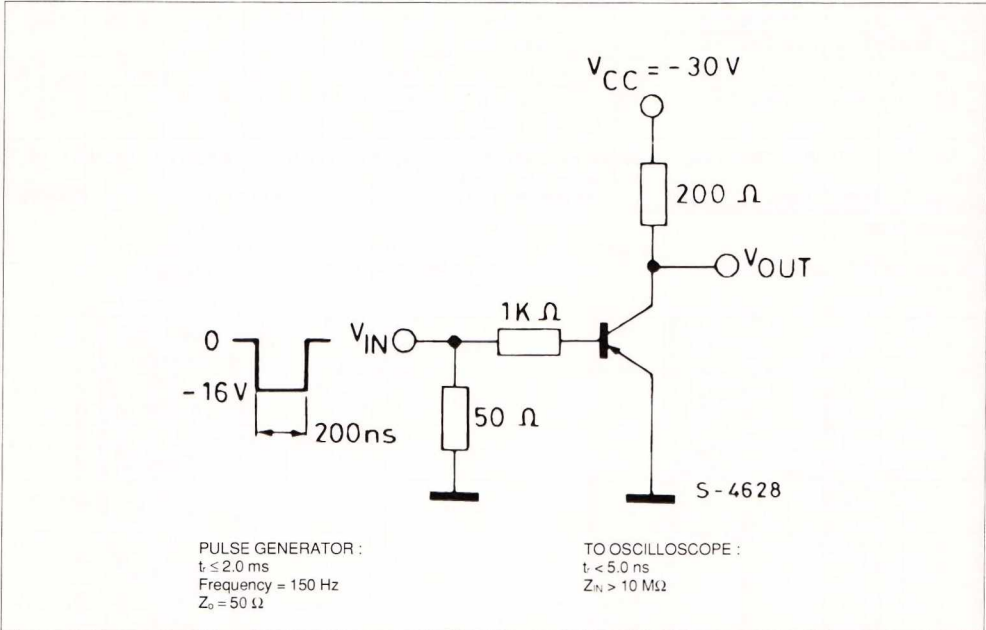

Test Circuit for t_{off} , t_o , t_r .

