

## GENERAL PURPOSE AMPLIFIERS AND SWITCHES

### DESCRIPTION

The 2N2904A, 2N2905A, 2N2906A and 2N2907A are silicon planar epitaxial PNP transistors in Jedec TO-39 (for 2N2904A and 2N2905A) and in Jedec TO-18 (for 2N2906A and 2N2907A) metal cases. They are designed for high-speed saturated switching and general purpose applications.

☰ 2N2904A/2N2905A approved to CECC 50002-100, 2N2906A/2N2907A approved to CECC 50002-103 available on request.

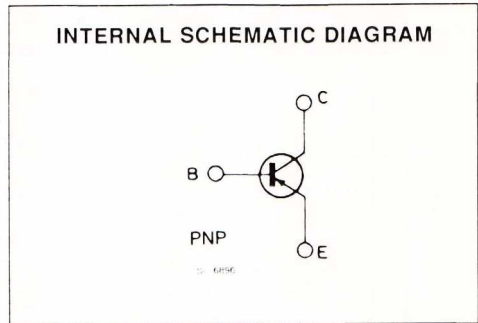
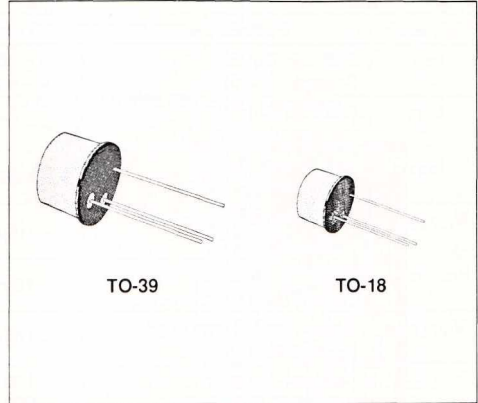

### ABSOLUTE MAXIMUM RATINGS

Symbol	Parameter	Value	Unit
$V_{CBO}$	Collector-base Voltage ( $I_E = 0$ )	- 60	V
$V_{CEO}$	Collector-emitter Voltage ( $I_B = 0$ )	- 60	V
$V_{EBO}$	Emitter-base Voltage ( $I_C = 0$ )	- 5	V
$I_C$	Collector Current	- 600	mA
$P_{TOT}$	Total Power Dissipation at $T_{amb} \leq 25^\circ\text{C}$		
	for 2N2904A and 2N2905A	0.6	W
	for 2N2906A and 2N2907A	0.4	W
	at $T_{case} \leq 25^\circ\text{C}$		
	for 2N2904A and 2N2905A	3	W
	for 2N2906A and 2N2907A	1.8	W
$T_{stg}, T_j$	Storage and Junction Temperature	- 65 to 200	$^\circ\text{C}$

**THERMAL DATA**

			2N2904A 2N2905A	2N2906A 2N2907A
R <sub>th j-case</sub>	Thermal Resistance Junction-case	Max	58.3 °C/W	97.3 °C/W
R <sub>th j-amb</sub>	Thermal Resistance Junction-ambient	Max	292 °C/W	437.5 °C/W

**ELECTRICAL CHARACTERISTICS** (T<sub>amb</sub> = 25 °C unless otherwise specified)

Symbol	Parameter	Test Conditions	Min.	Typ.	Max.	Unit
I <sub>CBO</sub>	Collector Cutoff Current (I <sub>E</sub> = 0)	V <sub>CB</sub> = - 50 V V <sub>CB</sub> = - 50 V T <sub>amb</sub> = 150 °C			- 10 - 10	nA μA
I <sub>CEX</sub>	Collector Cutoff Current (V <sub>BE</sub> = 0.5 V)	V <sub>CE</sub> = - 30 V			- 50	nA
I <sub>BEX</sub>	Base Cutoff Current (V <sub>BE</sub> = 0.5 V)	V <sub>CE</sub> = - 30 V			- 50	nA
V <sub>(BR) CBO</sub>	Collector-base Breakdown Voltage (I <sub>E</sub> = 0)	I <sub>C</sub> = - 10 μA	- 60			V
V <sub>(BR) CEO</sub> *	Collector-emitter Breakdown Voltage (I <sub>B</sub> = 0)	I <sub>C</sub> = - 10 mA	- 60			V
V <sub>(BR) EBO</sub>	Emitter-base Breakdown Voltage (I <sub>C</sub> = 0)	I <sub>E</sub> = - 10 μA	- 5			V
V <sub>CE (sat)</sub> *	Collector-emitter Saturation Voltage	I <sub>C</sub> = - 150 mA I <sub>B</sub> = - 15 mA I <sub>C</sub> = - 500 mA I <sub>B</sub> = - 50 mA			- 0.4 - 1.6	V V
V <sub>BE (sat)</sub> *	Base-emitter Saturation Voltage	I <sub>C</sub> = - 150 mA I <sub>B</sub> = - 16 mA I <sub>C</sub> = - 500 mA I <sub>B</sub> = - 50 mA			- 1.3 - 2.6	V V
h <sub>FE</sub> *	DC Current Gain	for <b>2N2904A</b> and <b>2N2906A</b> I <sub>C</sub> = - 0.1 mA V <sub>CE</sub> = - 10 V I <sub>C</sub> = - 1 mA V <sub>CE</sub> = - 10 V I <sub>C</sub> = - 10 mA V <sub>CE</sub> = - 10 V I <sub>C</sub> = - 150 mA V <sub>CE</sub> = - 10 V I <sub>C</sub> = - 500 mA V <sub>CE</sub> = - 10 V	40 40 40 40 40		120	
h <sub>FE</sub> *	DC Current Gain	for <b>2N2905A</b> and <b>2N2907A</b> I <sub>C</sub> = - 0.1 mA V <sub>CE</sub> = - 10 V I <sub>C</sub> = - 1 mA V <sub>CE</sub> = - 10 V I <sub>C</sub> = - 10 mA V <sub>CE</sub> = - 10 V I <sub>C</sub> = - 150 mA V <sub>CE</sub> = - 10 V I <sub>C</sub> = - 500 mA V <sub>CE</sub> = - 10 V	75 100 100 100 50		300	
f <sub>T</sub>	Transition Frequency	I <sub>C</sub> = - 50 mA f = 100 MHz V <sub>CE</sub> = - 20 V	200			MHz
C <sub>EBO</sub>	Emitter-base Capacitance	I <sub>C</sub> = 0 f = 1 MHz V <sub>EB</sub> = - 2 V			30	pF
C <sub>CBO</sub>	Collector-base Capacitance	I <sub>E</sub> = 0 f = 1 MHz V <sub>CB</sub> = - 10 V			8	pF
t <sub>d</sub> **	Delay Time	I <sub>C</sub> = - 150 mA I <sub>B1</sub> = - 15 mA V <sub>CC</sub> = - 30 V			10	ns
t <sub>r</sub> **	Rise Time	I <sub>C</sub> = - 150 mA I <sub>B1</sub> = - 15 mA V <sub>CC</sub> = - 30 V			40	ns
t <sub>s</sub> **	Storage Time	I <sub>C</sub> = - 150 mA V <sub>CC</sub> = - 6 V I <sub>B1</sub> = - I <sub>B2</sub> = - 15 mA			80	ns

\* Pulsed : pulse duration = 300 μs, duty cycle = 1.5 %.

\*\* See test circuit.

ELECTRICAL CHARACTERISTICS (continued)

Symbol	Parameter	Test Conditions	Min.	Typ.	Max.	Unit
$t_f$ **	Fall Time	$I_C = -150 \text{ mA}$ $V_{CC} = -6 \text{ V}$ $I_{B1} = -I_{B2} = -15 \text{ mA}$			30	ns
$t_{on}$ **	Turn-on Time	$I_C = -150 \text{ mA}$ $V_{CC} = -30 \text{ V}$ $I_{B1} = -15 \text{ mA}$			45	ns
$t_{off}$ **	Turn-off Time	$I_C = -150 \text{ mA}$ $V_{CC} = -6 \text{ V}$ $I_{B1} = -I_{B2} = -15 \text{ mA}$			100	ns

\* Pulsed : pulse duration = 300  $\mu$ s, duty cycle = 1.5 %.  
\*\* see test circuit.

Normalized DC Current Gain.

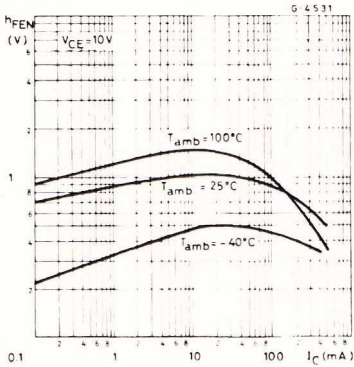

Collector-emitter Saturation Voltage.

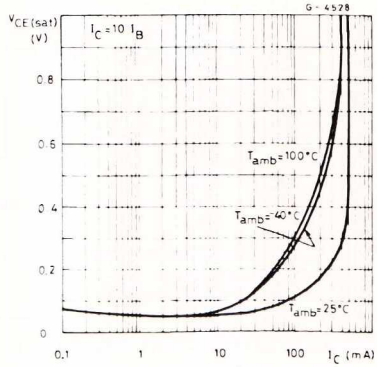

Collector-base and Emitter-base capacitances.

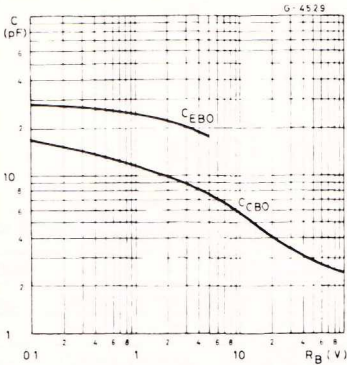

Switching Characteristics.

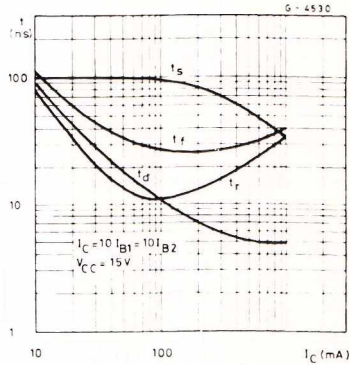

Test Circuit for  $t_{on}$ ,  $t_r$ ,  $t_d$ .

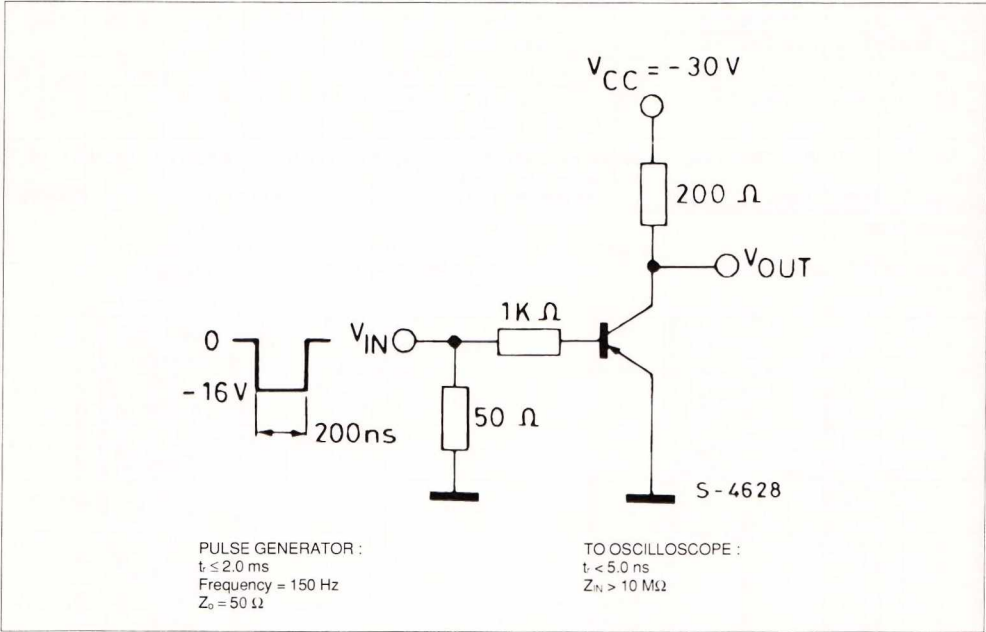

Test Circuit for  $t_{off}$ ,  $t_b$ ,  $t_r$ .

