

## HIGH-VOLTAGE AMPLIFIERS

### DESCRIPTION

The 2N3930 and 2N3931 are silicon planar epitaxial PNP transistors in Jedec TO-18 (2N3930) and Jedec TO-39 (2N3931) metal cases.

Both devices feature high voltage, high gain, low noise and excellent current gain linearity from 10  $\mu$ A to 50 mA.

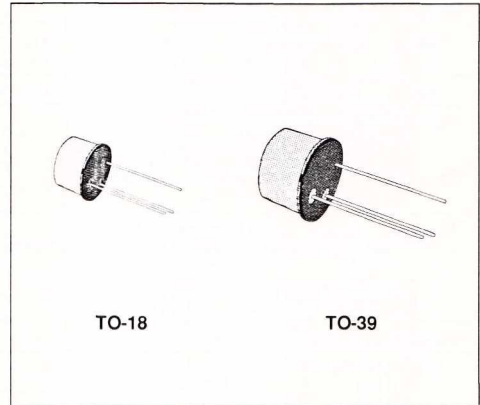

### INTERNAL SCHEMATIC DIAGRAM

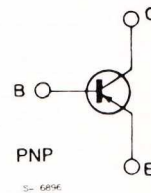

### ABSOLUTE MAXIMUM RATINGS

Symbol	Parameter	Value	Unit
$V_{CBO}$	Collector-base Voltage ( $I_E = 0$ )	- 180	V
$V_{CEO}$	Collector-emitter Voltage ( $I_B = 0$ )	- 180	V
$V_{EBO}$	Emitter-base Voltage ( $I_C = 0$ )	- 6	V
$I_C$	Collector Current	- 100	mA
$P_{tot}$	Total Power Dissipation at $T_{amb} \leq 25^\circ\text{C}$		
	For <b>2N3930</b>	0.4	W
	For <b>2N3931</b>	0.7	W
	at $T_{case} \leq 25^\circ\text{C}$		
	For <b>2N3930</b>	1.4	W
	For <b>2N3931</b>	2.5	W
$T_{stg}, T_j$	Storage and Junction Temperature	- 55 to 200	$^\circ\text{C}$

**THERMAL DATA**

			2N3930	2N3931
$R_{th\ j-case}$	Thermal Resistance Junction-case	Max	125 °C/W	70 °C/W
$R_{th\ j-amb}$	Thermal Resistance Junction-ambient	Max	438 °C/W	250 °C/W

**ELECTRICAL CHARACTERISTICS** ( $T_{amb} = 25\text{ °C}$  unless otherwise specified)

Symbol	Parameter	Test Conditions	Min.	Typ.	Max.	Unit
$I_{CBO}$	Collector Cutoff Current ( $I_E = 0$ )	$V_{CB} = -100\text{ V}$ $V_{CB} = -100\text{ V}$ $T_{amb} = 125\text{ °C}$			- 10 - 10	nA μA
$I_{EBO}$	Emitter Cutoff Current ( $I_C = 0$ )	$V_{EB} = -4\text{ V}$			- 10	nA
$V_{(BR)CBO}$	Collector-base Breakdown Voltage ( $I_E = 0$ )	$I_C = -10\text{ μA}$	- 180			V
$V_{(BR)CEO}^*$	Collector-emitter Breakdown Voltage ( $I_B = 0$ )	$I_C = -2\text{ mA}$	- 180			V
$V_{(BR)EBO}$	Emitter-base Breakdown Voltage ( $I_C = 0$ )	$I_E = -10\text{ μA}$	- 6			V
$V_{CE(sat)}^*$	Collector-emitter Saturation Voltage	$I_C = -10\text{ mA}$ $I_B = -1\text{ mA}$		- 0.1	- 0.25	V
$V_{BE(sat)}^*$	Base-emitter Saturation Voltage	$I_C = -10\text{ mA}$ $I_B = -1\text{ mA}$		- 0.74	- 0.9	V
$h_{FE}^*$	DC Current Gain	$I_C = -10\text{ μA}$ $V_{CE} = -10\text{ V}$ $I_C = -1\text{ mA}$ $V_{CE} = -10\text{ V}$ $I_C = -10\text{ mA}$ $V_{CE} = -10\text{ V}$ $I_C = -10\text{ μA}$ $V_{CE} = -10\text{ V}$ $T_{amb} = -55\text{ °C}$ $I_C = -100\text{ μA}$ $V_{CE} = -10\text{ V}$ $T_{amb} = -55\text{ °C}$	60 80 80 15 30	110 170 200 60 90	300	
$f_T$	Transition Frequency	$I_C = -1\text{ mA}$ $V_{CE} = -10\text{ V}$ $f = 20\text{ MHz}$	40	60	160	MHz
$C_{EBO}$	Emitter-base Capacitance	$I_C = 0$ $V_{EB} = -0.5\text{ V}$ $f = 1\text{ MHz}$		20	25	pF
$C_{CBO}$	Collector-base Capacitance	$I_E = 0$ $V_{CB} = -5\text{ V}$ $f = 1\text{ MHz}$		5	7	pF
NF	Noise Figure	$I_C = -10\text{ μA}$ $V_{CE} = -5\text{ V}$ $R_g = 10\text{ k}\Omega$ $f = 10\text{ kHz}$ $B = 2\text{ kHz}$ $f = 1\text{ kHz}$ $B = 200\text{ Hz}$ $f = 100\text{ Hz}$ $B = 20\text{ Hz}$		1 1 2	3 3 10	dB dB dB

\* Pulsed : pulse duration = 300 μs, duty cycle = 1 %.

DC Current Gain.

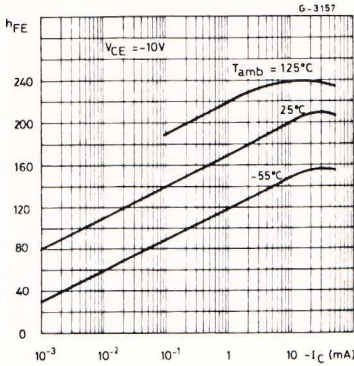

Collector-emitter Saturation Voltage.

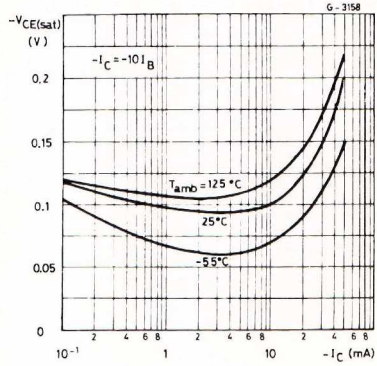

Base-emitter Saturation Voltage.

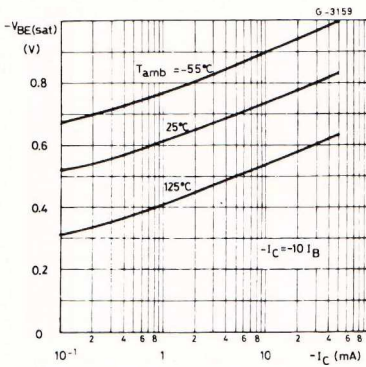

Emitter-base and collector-base capacitances.

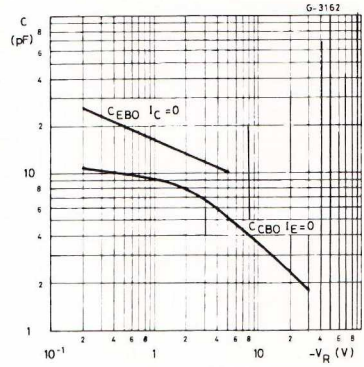

Contours of Constant Transition Frequency.

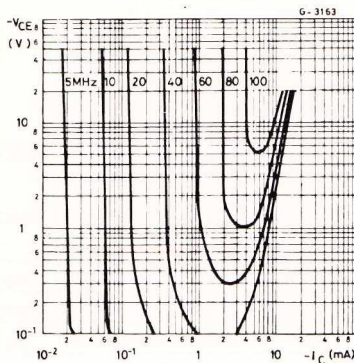

Contours of Constant Noise Figure (f = 100 Hz).

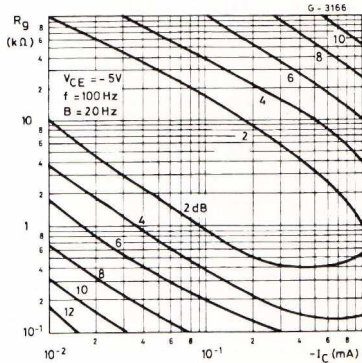

Contours of Constant Noise Figure ( $f = 1 \text{ kHz}$ ).

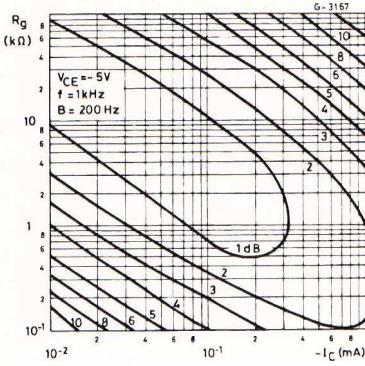

Contours of Constant Noise Figure ( $f = 10 \text{ kHz}$ ).

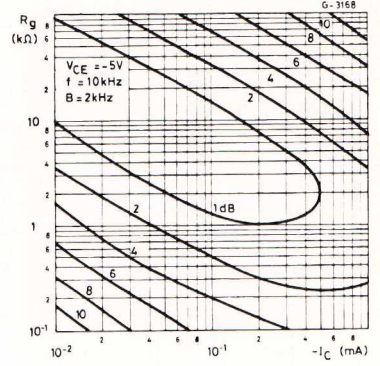

Contours of Constant Wide Band Noise Figure.

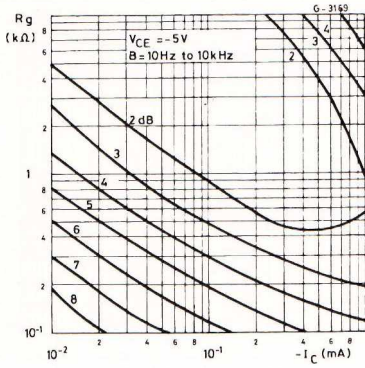

Noise Figure vs. Frequency.

