

COMPLEMENTARY POWER DARLINGTONS

DESCRIPTION

The 2N6282, 2N6283 and 2N6284 and the complementary PNP types 2N6285, 2N6286, 2N6287 are epitaxial-base silicon transistors in monolithic Darlington configuration in Jedec TO-3 metal Case. They are intended for general-purpose amplifier and low-frequency switching applications.

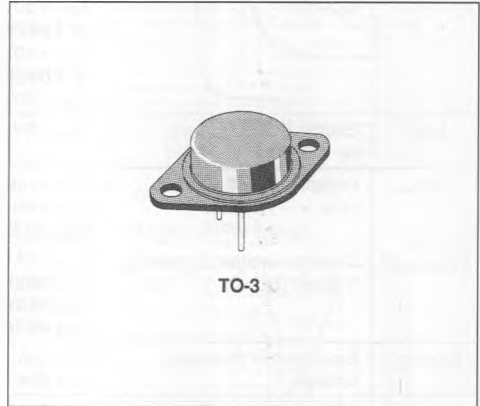

INTERNAL SCHEMATIC DIAGRAMS



ABSOLUTE MAXIMUM RATINGS

Symbol	Parameter	PNP	2N6282	2N6283	2N6284	Unit
		NPN	2N6285	2N6286	2N6287	
V_{CEO}	Collector-emitter Voltage ($I_B = 0$)		60	80	100	V
V_{CBO}	Collector-base Voltage ($I_E = 0$)		60	80	100	V
V_{EBO}	Emitter-base Voltage ($I_C = 0$)			5		V
I_C	Collector Current			20		A
I_{CM}	Collector Peak Current			40		A
I_B	Base Current			0.5		A
P_{Tot}	Total Power Dissipation at $T_{Case} \leq 25^\circ C$			160		W
T_{stg}	Storage Temperature			- 65 to 200		$^\circ C$
T_J	Junction Temperature			200		$^\circ C$

For PNP types voltage and current values are negative.

THERMAL DATA

$R_{th\ J-case}$	Thermal Resistance Junction-case	Max	1.09	°C/W
------------------	----------------------------------	-----	------	------

ELECTRICAL CHARACTERISTICS ($T_{case} = 25^{\circ}C$ unless otherwise specified)

Symbol	Parameter	Test Conditions	Min.	Typ.	Max.	Unit
I_{CEO}	Collector Cutoff Current ($I_B = 0$)	for 2N6282, 2N6285 $V_{CE} = 30V$ for 2N6283, 2N6286 $V_{CE} = 40V$ for 2N6284, 2N6287 $V_{CE} = 50V$			1	mA
I_{EBO}	Emitter Cutoff Current ($I_C = 0$)	$V_{EB} = 5V$			2	mA
I_{CEV}	Collector Cutoff Current ($V_{BE} = -1.5V$)	$V_{CE} = \text{rated } V_{CBO}$ $V_{CE} = \text{rated } V_{CBO}$ $T_{case} = 150^{\circ}C$			0.5 5	mA mA
$V_{CEO(sus)}^*$	Collector-emitter Sustaining Voltage ($I_B = 0$)	$I_C = 0.1A$ for 2N6282, 2N6285 for 2N6283, 2N6286 for 2N6284, 2N6287	60 80 100			V V V
$V_{CE(sat)}^*$	Base-emitter Saturation Voltage	$I_C = 10A$ $I_B = 40mA$ $I_C = 20A$ $I_B = 200mA$			2 3	V V
$V_{BE(sat)}^*$	Collector-emitter Saturation Voltage	$I_C = 20A$ $I_B = 200mA$			4	V
V_{BE}^*	Base-emitter Voltage	$I_C = 10A$ $V_{CE} = 3V$			2.8	V
h_{FE}^*	DC Current Gain	$I_C = 10A$ $V_{CE} = 3V$ $I_C = 20A$ $V_{CE} = 3V$	750 100		18000	
C_{CBO}	Collector-base Capacitance	$V_{CB} = 10V$ $I_E = 0$ $f = 0.1MHz$ for 2N6282, 2N6283, 2N6284 for 2N6285, 2N6286, 2N6287			400 600	pF pF
h_{ie}	Small Signal Current Gain	$I_C = 10A$ $V_{CE} = 3V$ $f = 1KHz$	300			

* Pulsed : pulse duration = 300μs, duty cycle ≤ 2%.
For PNP types voltage and current values are negative.

Safe Operating Areas.

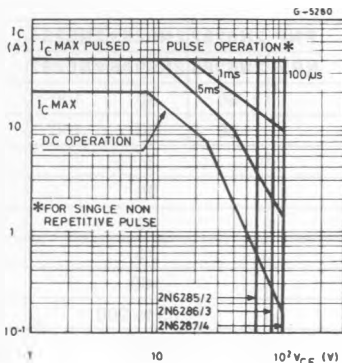

DC Current Gain (NPN types).

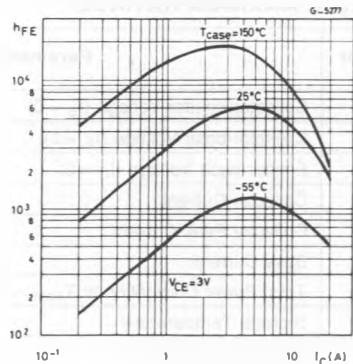

DC Current Gain (PNP types).

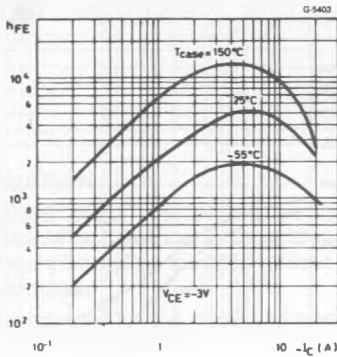

Collector-emitter Saturation Voltage (NPN types).

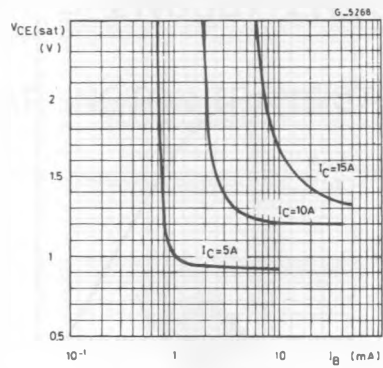

Collector-emitter saturation Voltage (PNP types).

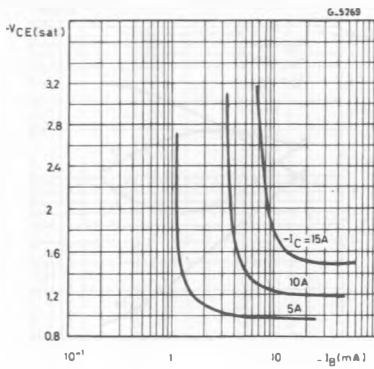

Saturation Voltages (NPN types).

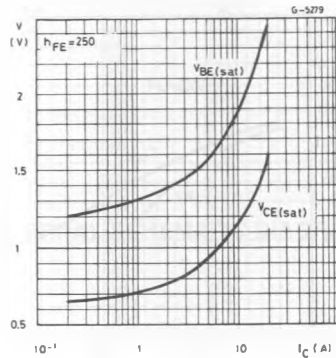

Saturation Voltages (PNP).

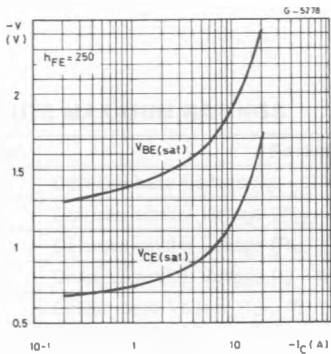

Small Signal Current Gain (NPN types).

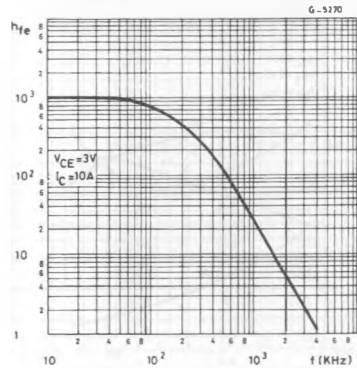

Small Signal Current Gain (PNP types).

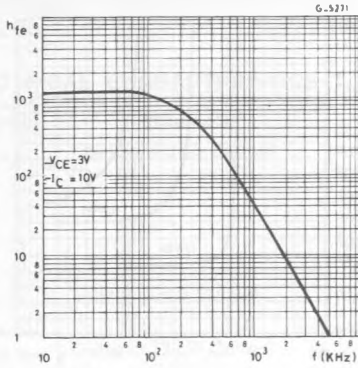

Capacitances (NPN types).

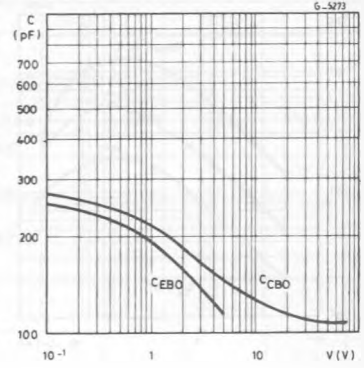

Capacitances (PNP types).

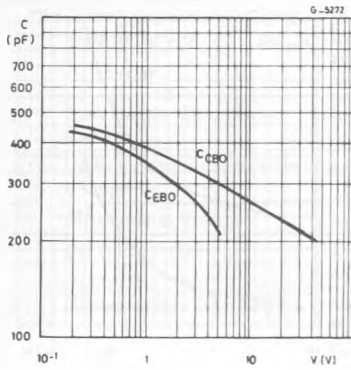

Saturated Switching Times (NPN types).

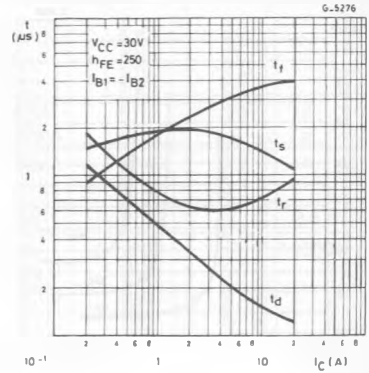

Saturated Switching Times (PNP types).

