



High-Definition CRT Display Applications

Features

- High f_T (Gain-Bandwidth Product).
- Small reverse transfer capacitance ($C_{re}=1.3\text{pF}$).
- Adoption of FBET process.

Package Dimensions

unit:mm

2006A

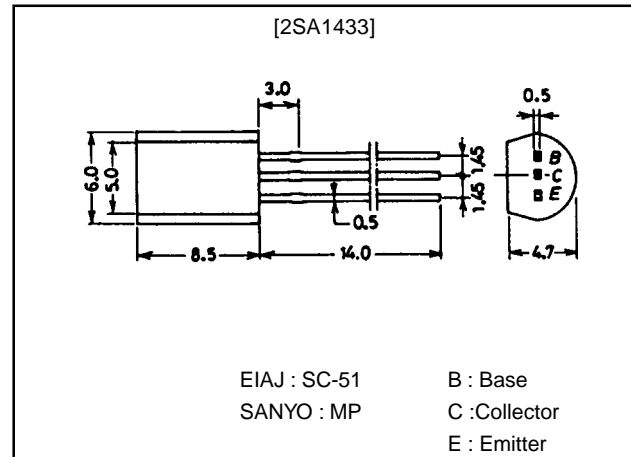

Specifications

Absolute Maximum Ratings at $T_a = 25^\circ\text{C}$

Parameter	Symbol	Conditions	Ratings	Unit
Collector-to-Base Voltage	V_{CB0}		-70	V
Collector-to-Emitter Voltage	V_{CE0}		-60	V
Emitter-to-Base Voltage	V_{EB0}		-4	V
Collector Current	I_C		-50	mA
Collector Current (Pulse)	I_{CP}		-100	mA
Collector Dissipation	P_C		900	mW
Junction Temperature	T_J		150	$^\circ\text{C}$
Storage Temperature	T_{stg}		-55 to +150	$^\circ\text{C}$

Electrical Characteristics at $T_a = 25^\circ\text{C}$

Parameter	Symbol	Conditions	Ratings			Unit
			min	typ	max	
Collector Cutoff Current	I_{CBO}	$V_{CB}=-40\text{V}, I_E=0$			(-)0.1	μA
Emitter Cutoff Current	I_{EBO}	$V_{EB}=-3\text{V}, I_C=0$			(-)1.0	μA
DC Current Gain	h_{FE}	$V_{CE}=-10\text{V}, I_C=-10\text{mA}$	60*		320*	
Gain-Bandwidth Product	f_T	$V_{CE}=-10\text{V}, I_C=-10\text{mA}$	350	700		MHz
Base-to-Collector Time Constant	τ_{bb}, τ_c	$V_{CE}=-10\text{V}, I_C=-10\text{mA}$		8		
Output Capacitance	C_{ob}	$V_{CB}=-10\text{V}, f=1\text{MHz}$		1.7		pF
Reverse Transfer Capacitance	C_{re}	$V_{CB}=-10\text{V}, f=1\text{MHz}$		1.3		pF
Collector-to-Emitter Saturation Voltage	$V_{CE(sat)}$	$I_C=-20\text{mA}, I_B=-2\text{mA}$			-0.6	V
Base-to-Emitter Saturation Voltage	$V_{BE(sat)}$	$I_C=-20\text{mA}, I_B=-2\text{mA}$			-1.0	V
Collector-to-Base Breakdown Voltage	$V_{(BR)CBO}$	$I_C=-10\mu\text{A}, I_E=0$	-70			V
Collector-to-Emitter Breakdown Voltage	$V_{(BR)CEO}$	$I_C=-1\text{mA}, R_{BE}=\infty$	-60			V
Emitter-to-Base Breakdown Voltage	$V_{(BR)EBO}$	$I_E=-10\mu\text{A}, I_C=0$	-4			V

* : The 2SA1433 is classified by 10mA h_{FE} as follows :

60	D	120	100	E	200	160	F	320
----	---	-----	-----	---	-----	-----	---	-----

h_{FE} rank : D, E, F

2SA1433

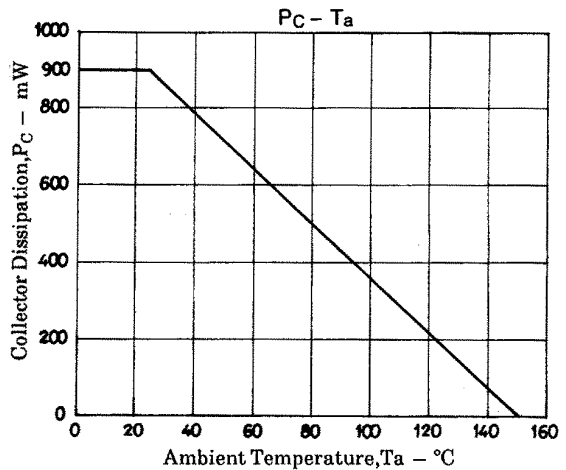
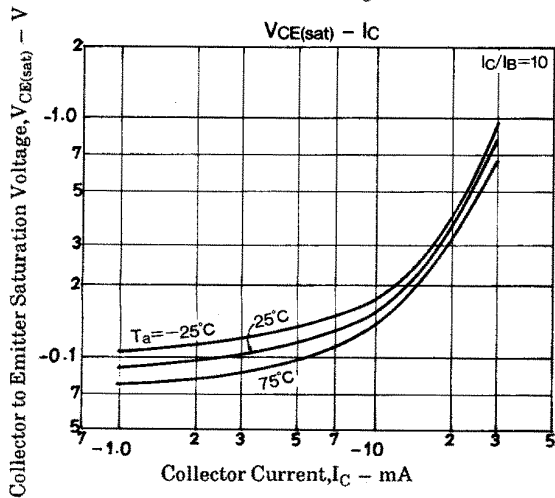
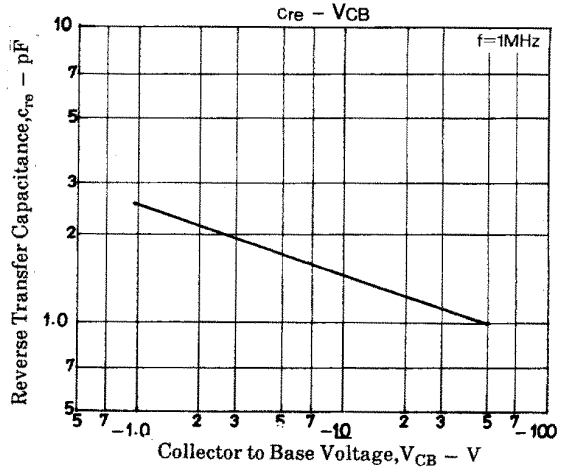
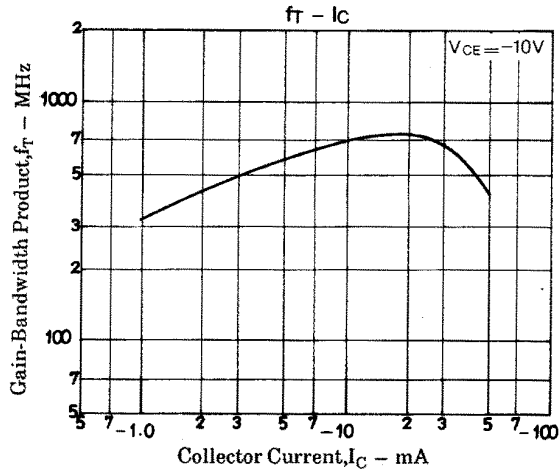
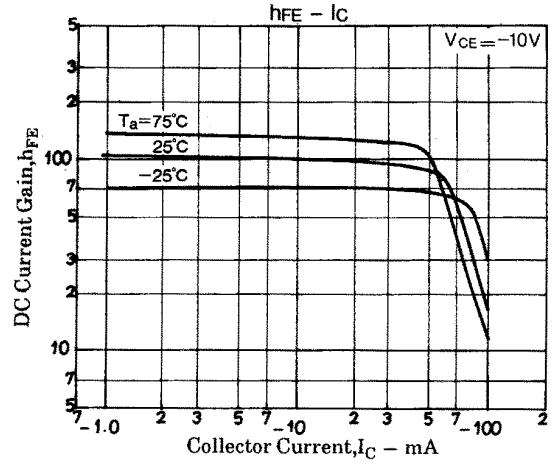
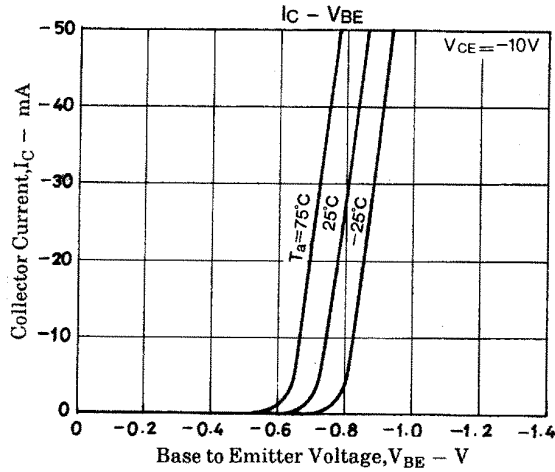

■ No products described or contained herein are intended for use in surgical implants, life-support systems, aerospace equipment, nuclear power control systems, vehicles, disaster/crime-prevention equipment and the like, the failure of which may directly or indirectly cause injury, death or property loss.

■ Anyone purchasing any products described or contained herein for an above-mentioned use shall:

- ① Accept full responsibility and indemnify and defend SANYO ELECTRIC CO., LTD., its affiliates, subsidiaries and distributors and all their officers and employees, jointly and severally, against any and all claims and litigation and all damages, cost and expenses associated with such use;
- ② Not impose any responsibility for any fault or negligence which may be cited in any such claim or litigation on SANYO ELECTRIC CO., LTD., its affiliates, subsidiaries and distributors or any of their officers and employees jointly or severally.

■ Information (including circuit diagrams and circuit parameters) herein is for example only; it is not guaranteed for volume production. SANYO believes information herein is accurate and reliable, but no guarantees are made or implied regarding its use or any infringements of intellectual property rights or other rights of third parties.

This catalog provides information as of July, 1998. Specifications and information herein are subject to change without notice.