

TOSHIBA Transistor Silicon NPN Epitaxial Planar Type

2SC5085

VHF~UHF Band Low Noise Amplifier Applications

- Low noise figure, high gain.
- $NF = 1.1\text{dB}$, $|S_{21e}|^2 = 11\text{dB}$ ($f = 1\text{GHz}$)

Maximum Ratings ($T_a = 25^\circ\text{C}$)

Characteristics	Symbol	Rating	Unit
Collector-base voltage	V_{CBO}	20	V
Collector-emitter voltage	V_{CEO}	12	V
Emitter-base voltage	V_{EBO}	3	V
Base current	I_B	40	mA
Collector current	I_C	80	mA
Collector power dissipation	P_C	100	mW
Junction temperature	T_j	125	$^\circ\text{C}$
Storage temperature range	T_{stg}	-55~125	$^\circ\text{C}$

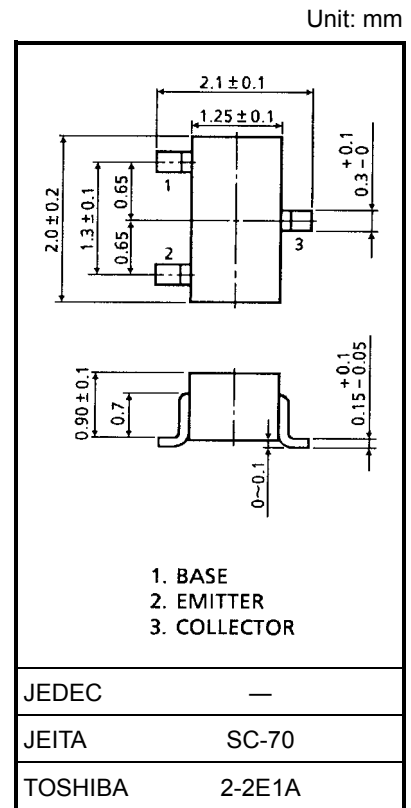

Microwave Characteristics ($T_a = 25^\circ\text{C}$)

Weight: 0.006 g (typ.)

Characteristics	Symbol	Test Condition	Min	Typ.	Max	Unit
Transition frequency	f_T	$V_{CE} = 10\text{V}$, $I_C = 20\text{mA}$	5	7	—	GHz
Insertion gain	$ S_{21e} ^2 (1)$	$V_{CE} = 10\text{V}$, $I_C = 20\text{mA}$, $f = 500\text{MHz}$	—	16.5	—	dB
	$ S_{21e} ^2 (2)$	$V_{CE} = 10\text{V}$, $I_C = 20\text{mA}$, $f = 1\text{GHz}$	7.5	11	—	
Noise figure	NF (1)	$V_{CE} = 10\text{V}$, $I_C = 5\text{mA}$, $f = 500\text{MHz}$	—	1	—	dB
	NF (2)	$V_{CE} = 10\text{V}$, $I_C = 5\text{mA}$, $f = 1\text{GHz}$	—	1.1	2	

Electrical Characteristics ($T_a = 25^\circ\text{C}$)

Characteristics	Symbol	Test Condition	Min	Typ.	Max	Unit
Collector cut-off current	I_{CBO}	$V_{CB} = 10\text{V}$, $I_E = 0$	—	—	1	μA
Emitter cut-off current	I_{EBO}	$V_{EB} = 1\text{V}$, $I_C = 0$	—	—	1	μA
DC current gain	h_{FE} (Note 1)	$V_{CE} = 10\text{V}$, $I_C = 20\text{mA}$	80	—	240	
Output capacitance	C_{ob}	$V_{CB} = 10\text{V}$, $I_E = 0$, $f = 1\text{MHz}$ (Note 2)	—	1.0	—	pF
Reverse transfer capacitance	C_{re}		—	0.65	1.15	pF

Note 1: h_{FE} classification O: 80~160, Y: 120~240

Note 2: C_{re} is measured by 3 terminal method with capacitance bridge.

Marking

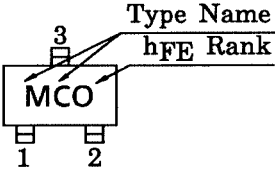

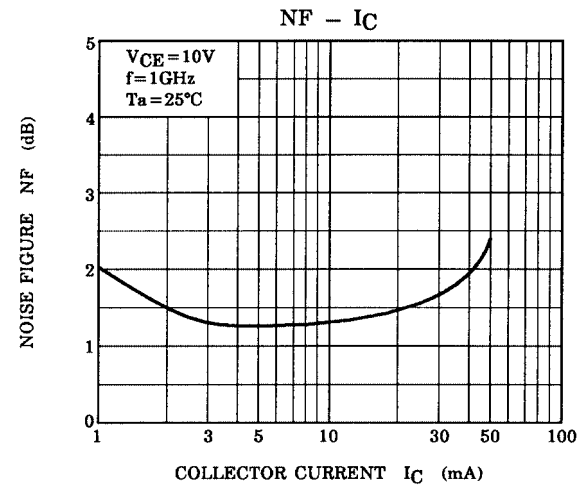
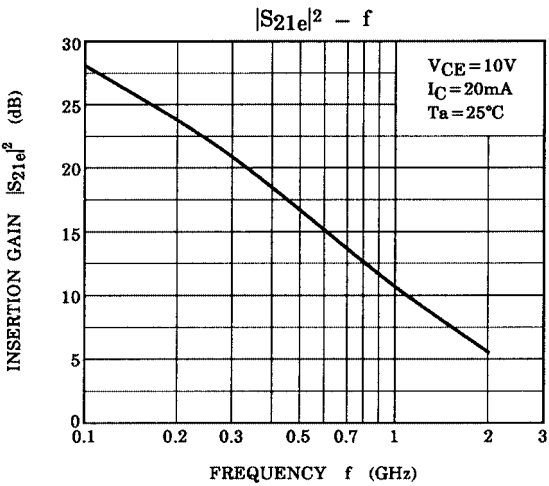
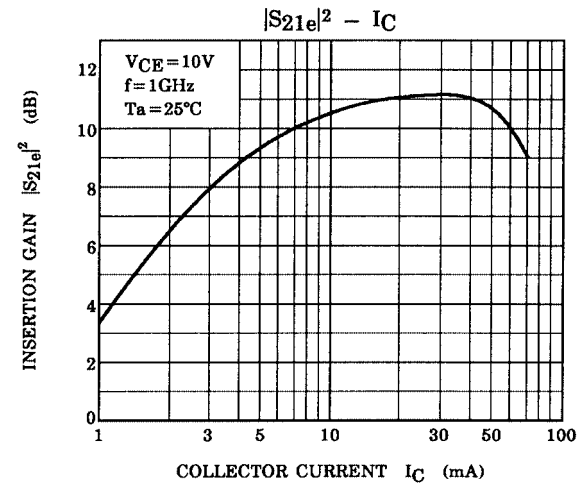
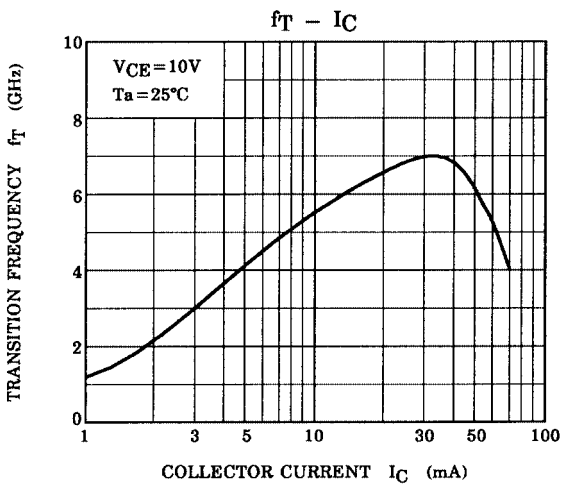
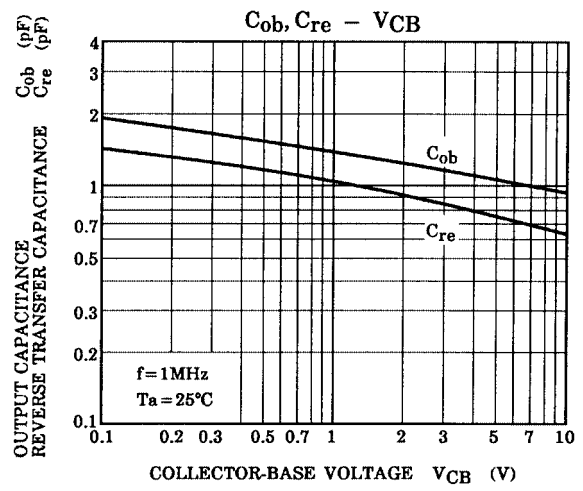
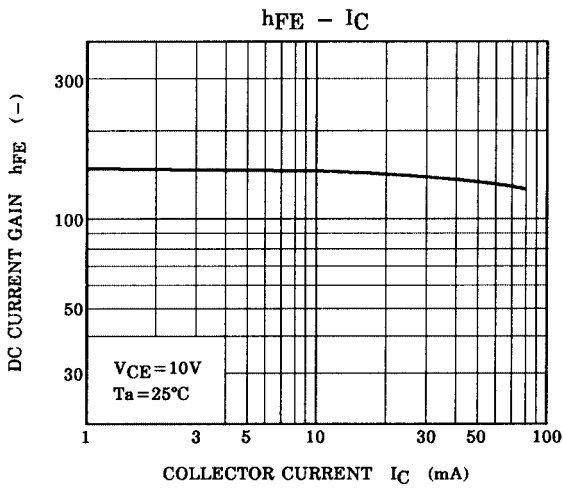

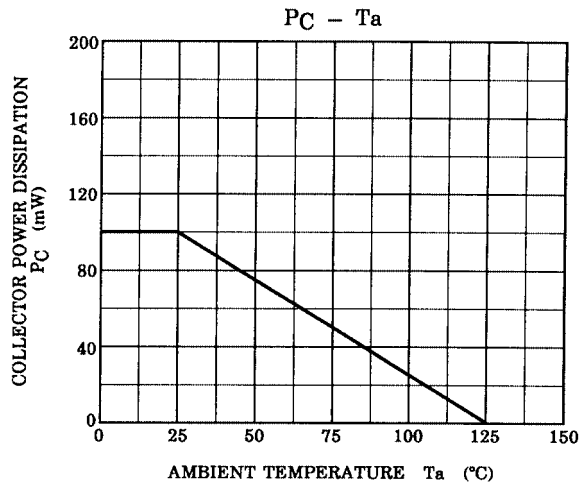
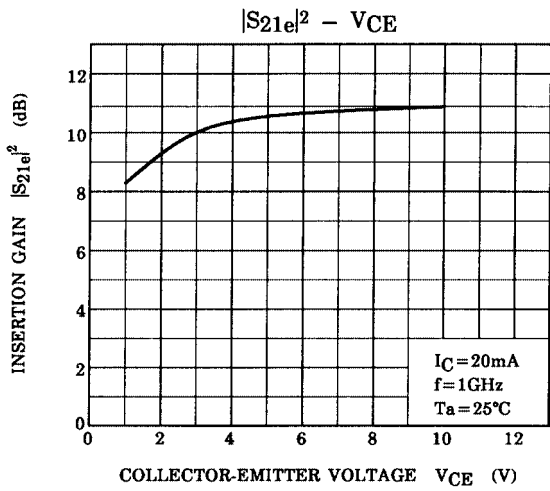

S-Parameter $Z_O = 50 \Omega, T_a = 25^\circ\text{C}$

$V_{CE} = 10 \text{ V}, I_C = 5 \text{ mA}$

Frequency (MHz)	S11		S21		S12		S22	
	Mag.	Ang.	Mag.	Ang.	Mag.	Ang.	Mag.	Ang.
200	0.672	-73.0	9.460	128.6	0.052	53.6	0.707	-31.3
400	0.498	-115.9	6.268	105.9	0.068	46.8	0.513	-36.2
600	0.443	-141.7	4.554	93.3	0.078	49.0	0.437	-36.6
800	0.426	-158.7	3.556	84.5	0.088	53.2	0.401	-36.8
1000	0.422	-171.9	2.948	77.5	0.099	57.9	0.383	-38.3
1200	0.428	177.5	2.526	71.1	0.113	62.7	0.373	-40.6
1400	0.437	168.3	2.240	65.5	0.133	65.8	0.367	-43.9
1600	0.449	159.9	1.997	60.1	0.152	67.6	0.362	-48.2
1800	0.464	153.1	1.821	55.0	0.171	68.7	0.358	-52.8
2000	0.485	146.7	1.686	50.9	0.195	70.6	0.350	-57.6

$V_{CE} = 10 \text{ V}, I_C = 20 \text{ mA}$

Frequency (MHz)	S11		S21		S12		S22	
	Mag.	Ang.	Mag.	Ang.	Mag.	Ang.	Mag.	Ang.
200	0.392	-116.4	16.247	109.3	0.034	59.7	0.420	-43.7
400	0.329	-152.1	8.775	94.5	0.054	66.0	0.280	-38.4
600	0.321	-170.6	6.018	86.3	0.075	69.5	0.244	-33.7
800	0.321	177.5	4.598	80.2	0.097	70.7	0.231	-31.7
1000	0.324	167.9	3.767	74.8	0.119	71.2	0.225	-31.3
1200	0.332	160.3	3.191	70.0	0.142	71.3	0.225	-32.7
1400	0.341	153.5	2.812	65.2	0.168	70.0	0.225	-36.2
1600	0.352	146.6	2.502	60.7	0.190	68.4	0.222	-40.3
1800	0.362	142.2	2.264	56.5	0.212	66.8	0.217	-44.9
2000	0.379	137.7	2.092	52.8	0.236	66.3	0.212	-49.4

S_{11e}
V_{CE} = 10V
I_C = 5mA
T_a = 25°C
 (UNIT : Ω)

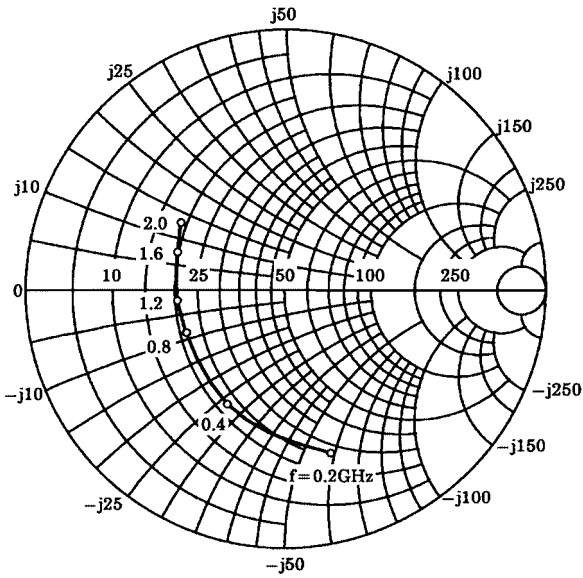

S_{21e}
V_{CE} = 10V
I_C = 5mA
T_a = 25°C

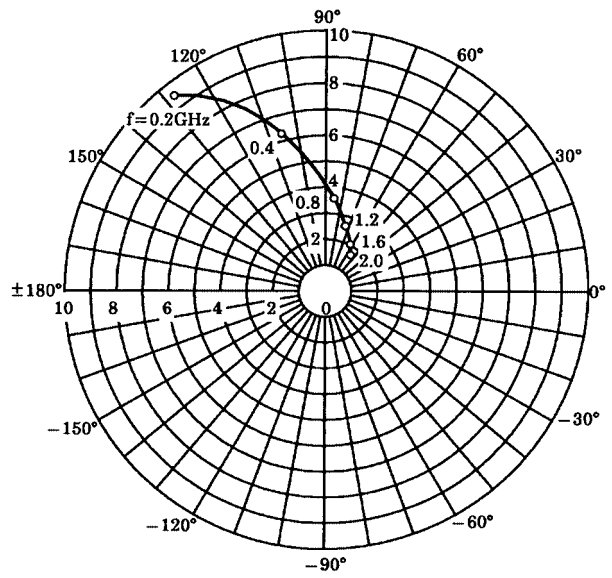

S_{12e}
V_{CE} = 10V
I_C = 5mA
T_a = 25°C

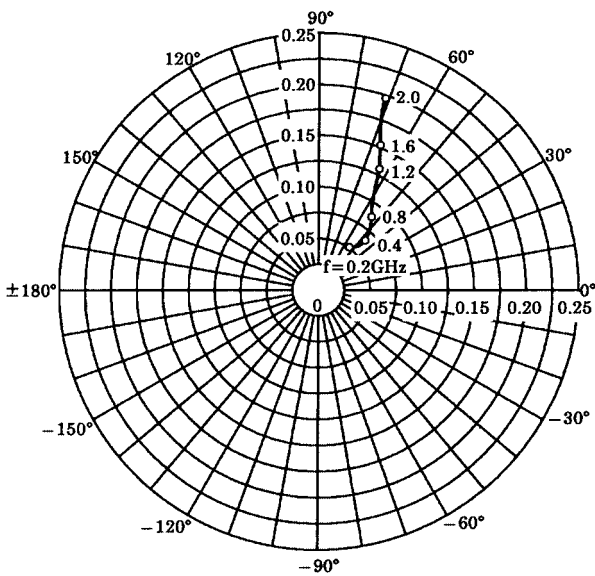

S_{22e}
V_{CE} = 10V
I_C = 5mA
T_a = 25°C
 (UNIT : Ω)

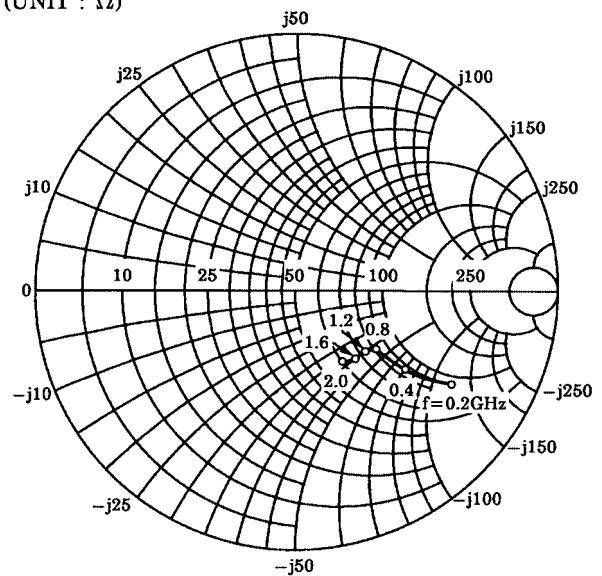

S11e
VCE = 10V
IC = 20mA
Ta = 25°C
(UNIT : Ω)

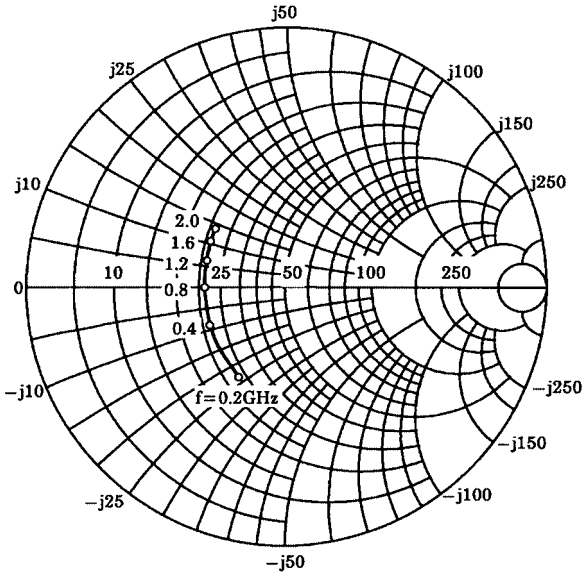

S21e
VCE = 10V
IC = 20mA
Ta = 25°C

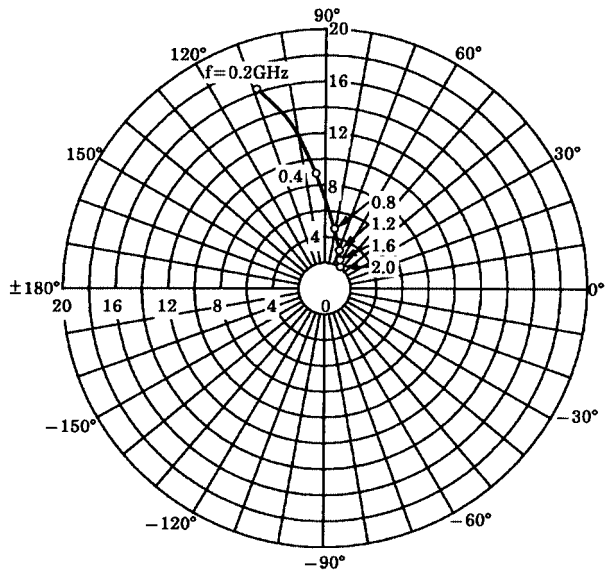

S12e
VCE = 10V
IC = 20mA
Ta = 25°C

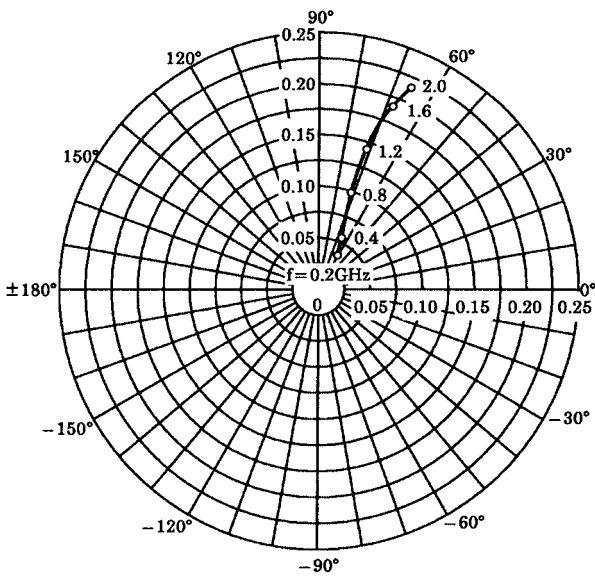

S22e
VCE = 10V
IC = 20mA
Ta = 25°C
(UNIT : Ω)

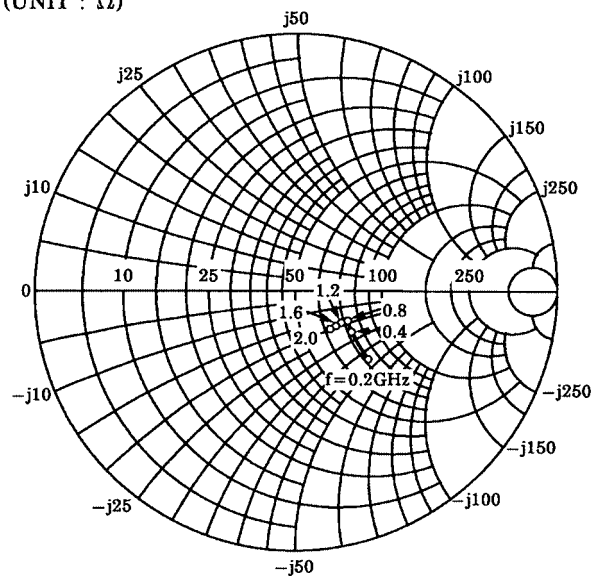

RESTRICTIONS ON PRODUCT USE

000707EAA

- TOSHIBA is continually working to improve the quality and reliability of its products. Nevertheless, semiconductor devices in general can malfunction or fail due to their inherent electrical sensitivity and vulnerability to physical stress. It is the responsibility of the buyer, when utilizing TOSHIBA products, to comply with the standards of safety in making a safe design for the entire system, and to avoid situations in which a malfunction or failure of such TOSHIBA products could cause loss of human life, bodily injury or damage to property.
In developing your designs, please ensure that TOSHIBA products are used within specified operating ranges as set forth in the most recent TOSHIBA products specifications. Also, please keep in mind the precautions and conditions set forth in the "Handling Guide for Semiconductor Devices," or "TOSHIBA Semiconductor Reliability Handbook" etc..
- The TOSHIBA products listed in this document are intended for usage in general electronics applications (computer, personal equipment, office equipment, measuring equipment, industrial robotics, domestic appliances, etc.). These TOSHIBA products are neither intended nor warranted for usage in equipment that requires extraordinarily high quality and/or reliability or a malfunction or failure of which may cause loss of human life or bodily injury ("Unintended Usage"). Unintended Usage include atomic energy control instruments, airplane or spaceship instruments, transportation instruments, traffic signal instruments, combustion control instruments, medical instruments, all types of safety devices, etc.. Unintended Usage of TOSHIBA products listed in this document shall be made at the customer's own risk.
- The information contained herein is presented only as a guide for the applications of our products. No responsibility is assumed by TOSHIBA CORPORATION for any infringements of intellectual property or other rights of the third parties which may result from its use. No license is granted by implication or otherwise under any intellectual property or other rights of TOSHIBA CORPORATION or others.
- The information contained herein is subject to change without notice.