

TOSHIBA Field Effect Transistor Silicon N Channel MOS Type (π-MOSII⁵)

2SK1930

Chopper Regulator, DC-DC Converter, and Motor Drive Applications

Unit: mm

- Low drain-source ON resistance : $R_{DS(ON)} = 3.0 \Omega$ (typ.)
- High forward transfer admittance : $|Y_{fs}| = 2.0 S$ (typ.)
- Low leakage current : $I_{DSS} = 300 \mu A$ (max) ($V_{DS} = 800 V$)
- Enhancement-mode : $V_{th} = 1.5 \sim 3.5 V$ ($V_{DS} = 10 V, I_D = 1 mA$)

Maximum Ratings (Ta = 25°C)

Characteristics		Symbol	Rating	Unit
Drain-source voltage		V_{DSS}	1000	V
Drain-gate voltage ($R_{GS} = 20 k\Omega$)		V_{DGR}	1000	V
Gate-source voltage		V_{GSS}	± 20	V
Drain current	DC (Note 1)	I_D	4	A
	Pulse (Note 1)	I_{DP}	12	
Drain power dissipation ($T_c = 25^\circ C$)		P_D	80	W
Channel temperature		T_{ch}	150	°C
Storage temperature range		T_{stg}	-55~150	°C

Thermal Characteristics

Characteristics	Symbol	Max	Unit
Thermal resistance, channel to case	$R_{th(ch-c)}$	1.56	°C / W
Thermal resistance, channel to ambient	$R_{th(ch-a)}$	83.3	°C / W

Note 1: Please use devices on condition that the channel temperature is below 150°C.

This transistor is an electrostatic sensitive device.
Please handle with caution.

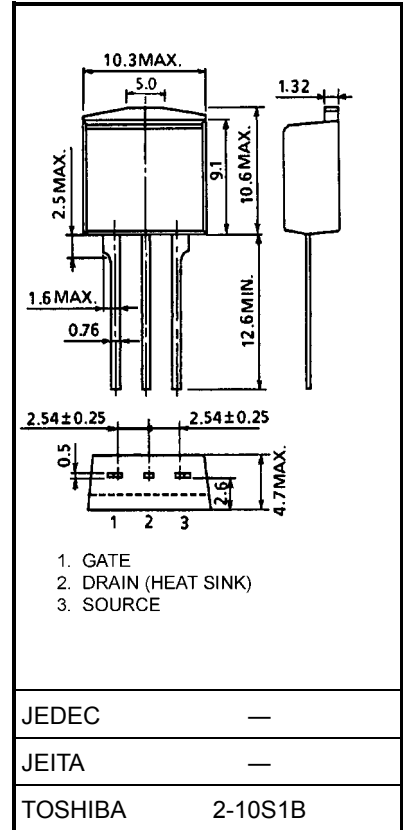

Weight: 1.5 g (typ.)

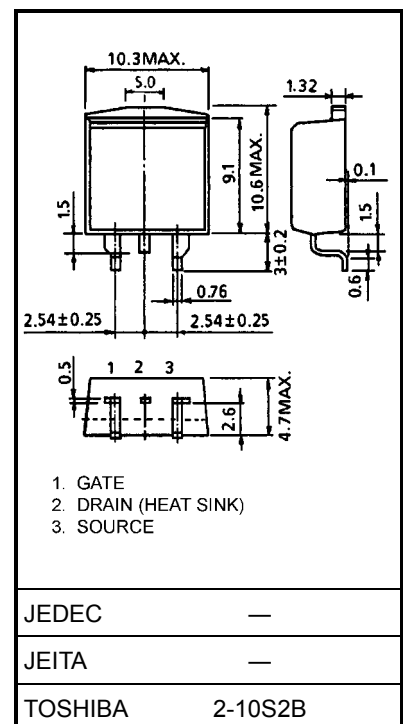

Weight: 1.5 g (typ.)

Electrical Characteristics (Ta = 25°C)

Characteristics		Symbol	Test Condition	Min	Typ.	Max	Unit
Gate leakage current		I_{GSS}	$V_{GS} = \pm 20\text{ V}, V_{DS} = 0\text{ V}$	—	—	± 100	nA
Drain cut-off current		I_{DSS}	$V_{DS} = 800\text{ V}, V_{GS} = 0\text{ V}$	—	—	300	μA
Drain-source breakdown voltage		$V_{(BR)DSS}$	$I_D = 10\text{ mA}, V_{GS} = 0\text{ V}$	1000	—	—	V
Gate threshold voltage		V_{th}	$V_{DS} = 10\text{ V}, I_D = 1\text{ mA}$	1.5	—	3.5	V
Drain-source ON resistance		$R_{DS(ON)}$	$V_{GS} = 10\text{ V}, I_D = 2\text{ A}$	—	3.0	3.8	Ω
Forward transfer admittance		$ Y_{fs} $	$V_{DS} = 20\text{ V}, I_D = 2\text{ A}$	1.0	2.0	—	S
Input capacitance		C_{iss}	$V_{DS} = 25\text{ V}, V_{GS} = 0\text{ V}, f = 1\text{ MHz}$	—	700	—	pF
Reverse transfer capacitance		C_{rss}		—	55	—	
Output capacitance		C_{oss}		—	100	—	
Switching time	Rise time	t_r	<p>$I_D = 2\text{ A}$ $R_L = 200\ \Omega$ $V_{DD} \approx 400\text{ V}$ Duty $\leq 1\%$, $t_w = 10\ \mu\text{s}$</p>	—	18	—	ns
	Turn-on time	t_{on}		—	30	—	
	Fall time	t_f		—	12	—	
	Turn-off time	t_{off}		—	70	—	
Total gate charge (Gate-source plus gate-drain)		Q_g	$V_{DD} \approx 400\text{ V}, V_{GS} = 10\text{ V}, I_D = 4\text{ A}$	—	60	—	nC
Gate-source charge		Q_{gs}		—	35	—	
Gate-drain ("miller") charge		Q_{gd}		—	25	—	

Source-Drain Ratings and Characteristics (Ta = 25°C)

Characteristics	Symbol	Test Condition	Min	Typ.	Max	Unit
Continuous drain reverse current (Note 1)	I_{DR}	—	—	—	4	A
Pulse drain reverse current (Note 1)	I_{DRP}	—	—	—	12	A
Forward voltage (diode)	V_{DSF}	$I_{DR} = 4\text{ A}, V_{GS} = 0\text{ V}$	—	—	-1.9	V

Marking

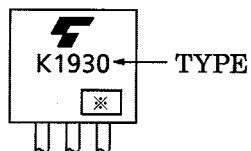

※ Lot Number

□ □ — Month (Starting from Alphabet A)

□ — Year (Last Number of the Christian Era)

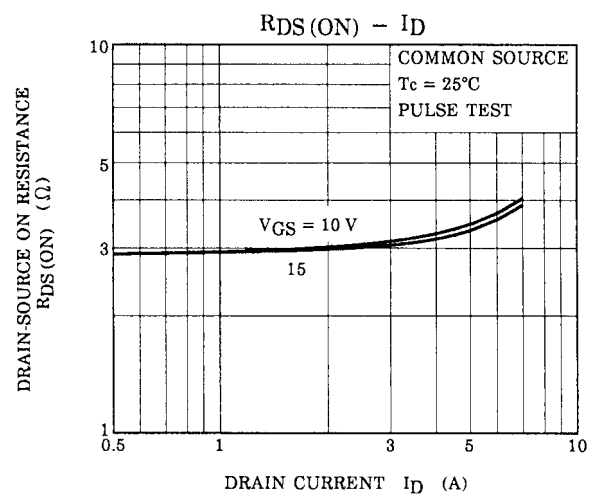
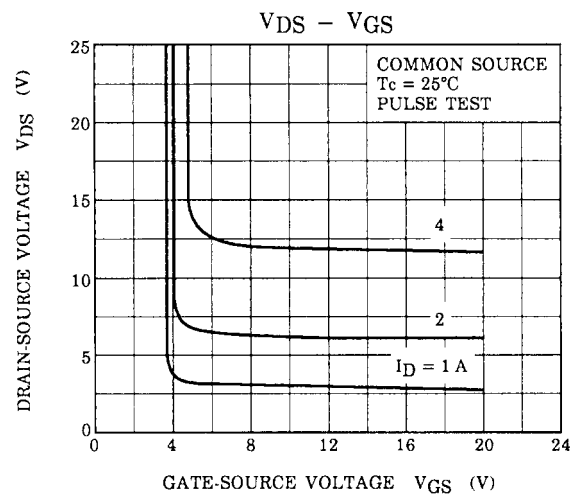
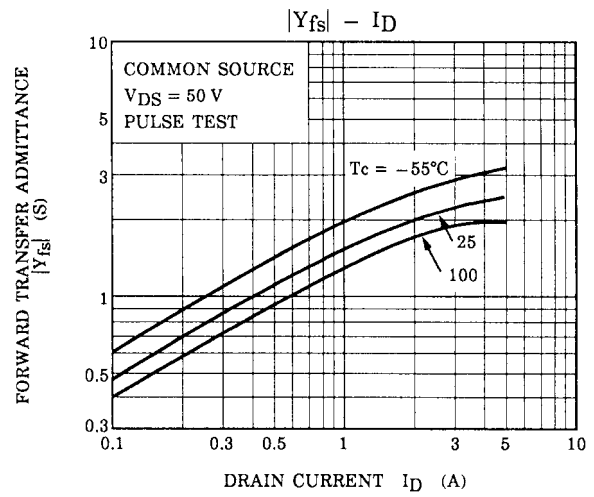
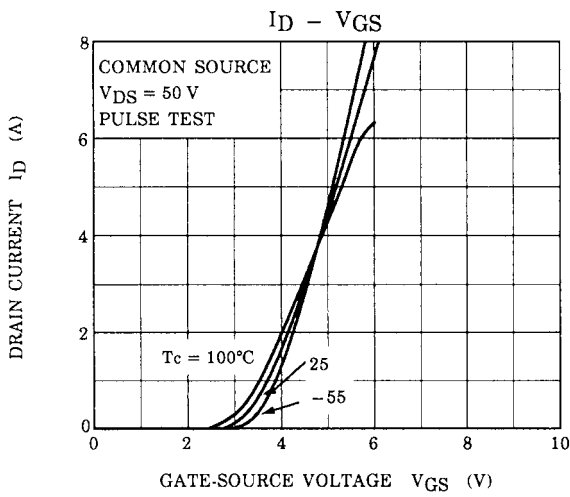
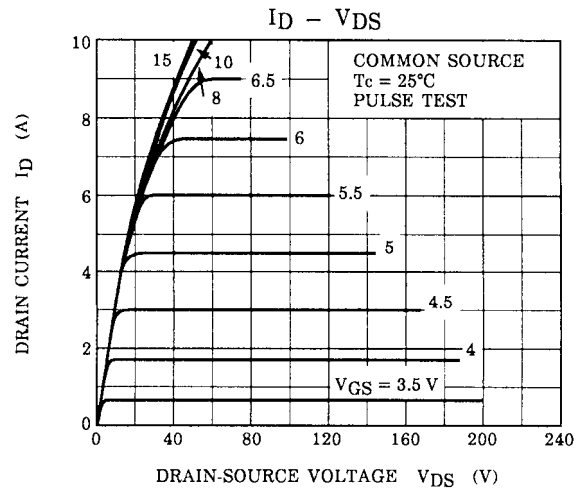
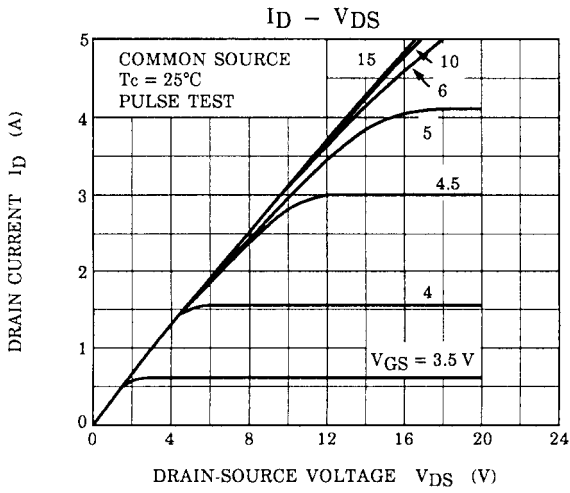

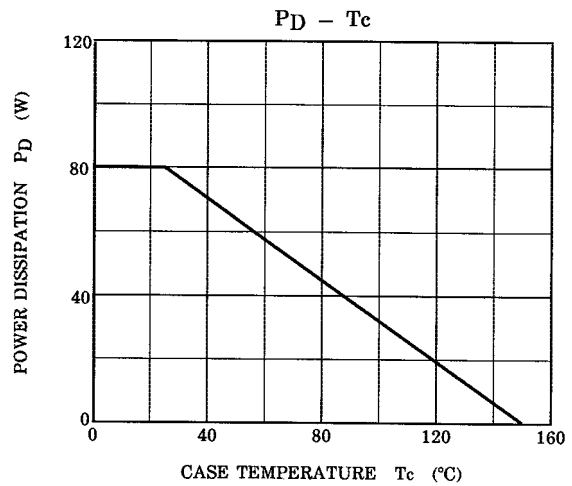
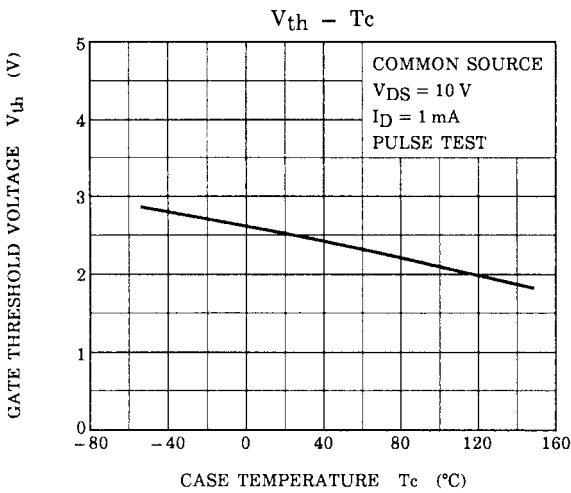
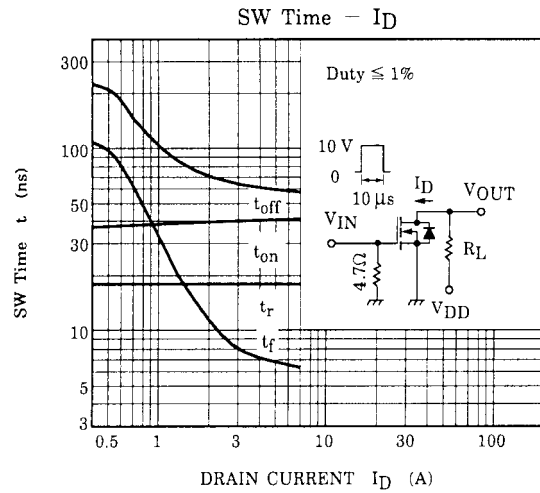
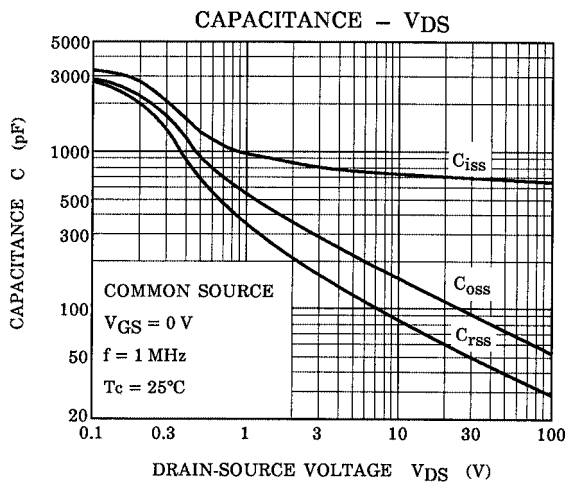
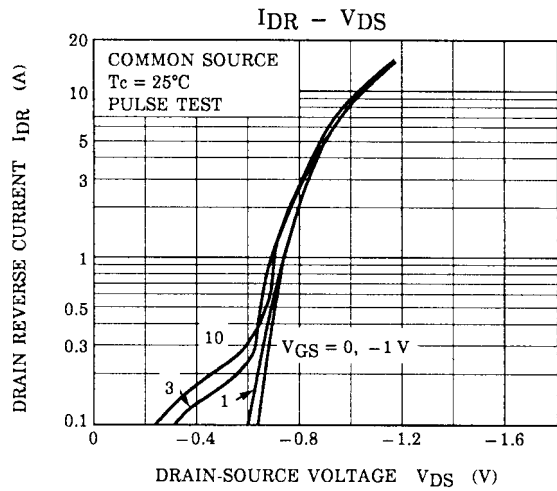
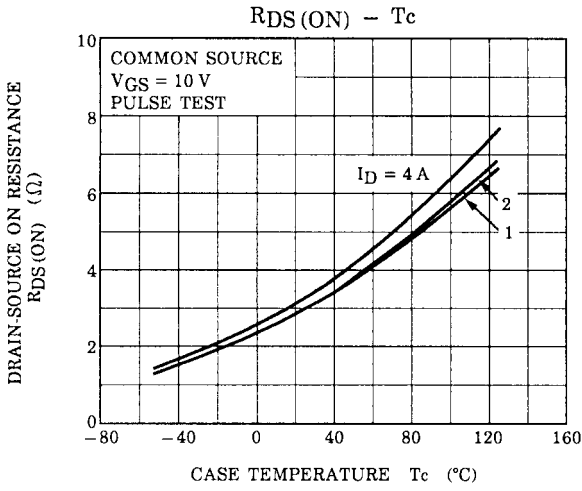

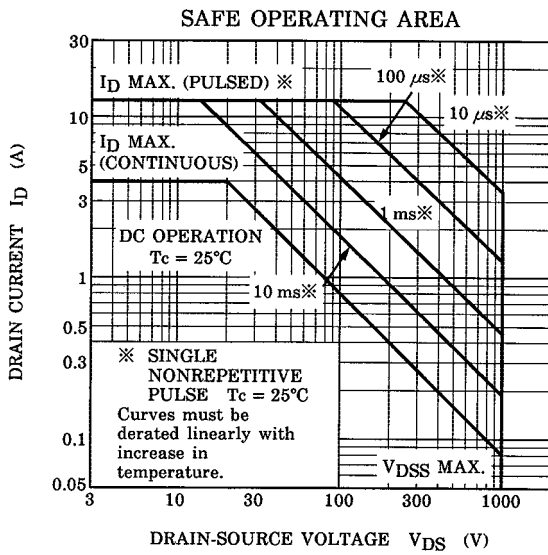
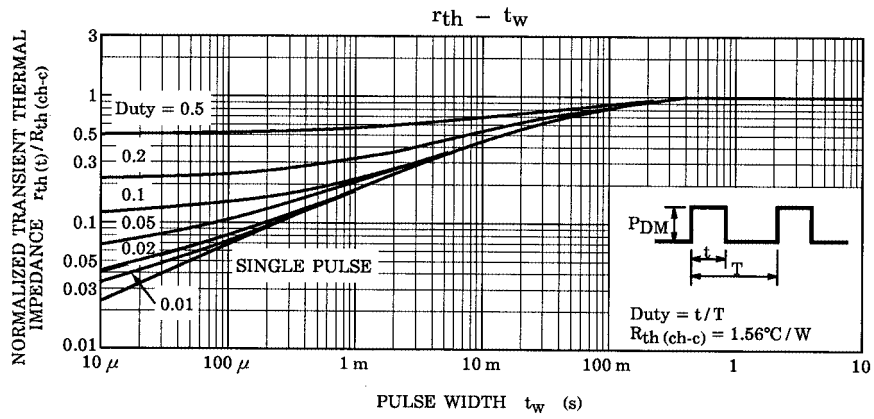

RESTRICTIONS ON PRODUCT USE

000707EAA

- TOSHIBA is continually working to improve the quality and reliability of its products. Nevertheless, semiconductor devices in general can malfunction or fail due to their inherent electrical sensitivity and vulnerability to physical stress. It is the responsibility of the buyer, when utilizing TOSHIBA products, to comply with the standards of safety in making a safe design for the entire system, and to avoid situations in which a malfunction or failure of such TOSHIBA products could cause loss of human life, bodily injury or damage to property.
In developing your designs, please ensure that TOSHIBA products are used within specified operating ranges as set forth in the most recent TOSHIBA products specifications. Also, please keep in mind the precautions and conditions set forth in the "Handling Guide for Semiconductor Devices," or "TOSHIBA Semiconductor Reliability Handbook" etc..
- The TOSHIBA products listed in this document are intended for usage in general electronics applications (computer, personal equipment, office equipment, measuring equipment, industrial robotics, domestic appliances, etc.). These TOSHIBA products are neither intended nor warranted for usage in equipment that requires extraordinarily high quality and/or reliability or a malfunction or failure of which may cause loss of human life or bodily injury ("Unintended Usage"). Unintended Usage include atomic energy control instruments, airplane or spaceship instruments, transportation instruments, traffic signal instruments, combustion control instruments, medical instruments, all types of safety devices, etc.. Unintended Usage of TOSHIBA products listed in this document shall be made at the customer's own risk.
- The information contained herein is presented only as a guide for the applications of our products. No responsibility is assumed by TOSHIBA CORPORATION for any infringements of intellectual property or other rights of the third parties which may result from its use. No license is granted by implication or otherwise under any intellectual property or other rights of TOSHIBA CORPORATION or others.
- The information contained herein is subject to change without notice.