

Switching (500V, 5A)

2SK2793

●Features

- 1) Low on-resistance.
- 2) Fast switching speed.
- 3) Wide SOA (safe operating area).
- 4) Gate-source voltage (V_{GS}) guaranteed to be $\pm 30V$.
- 5) Easily designed drive circuits.
- 6) Easy to parallel.

●Structure

Silicon N-channel
MOSFET

●External dimensions (Units: mm)

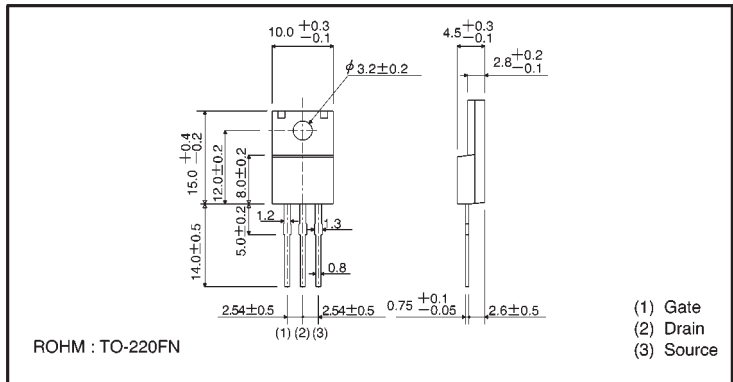

●Absolute maximum ratings ($T_a = 25^\circ C$)

Parameter	Symbol	Limits	Unit	
Drain-source voltage	V_{DS}	500	V	
Gate-source voltage	V_{GS}	± 30	V	
Drain current	Continuous	I_D	5	A
	Pulsed	I_{DP}^*	20	A
Reverse drain current	Continuous	I_{DR}	5	A
	Pulsed	I_{DRP}^*	20	A
Total power dissipation ($T_C=25^\circ C$)	P_D	30	W	
Channel temperature	T_{ch}	150	$^\circ C$	
Storage temperature	T_{stg}	$-55 \sim +150$	$^\circ C$	

* $P_w \leq 10 \mu s$, Duty cycle $\leq 1\%$

●Packaging specifications

Type	Package	Bulk
	Code	—
	Basic ordering unit (pieces)	500
2SK2793		○

●Electrical characteristics (Ta = 25°C)

Parameter	Symbol	Min.	Typ.	Max.	Unit	Test Conditions
Gate-source leakage	I_{GSS}	—	—	± 100	nA	$V_{GS}=\pm 30V, V_{DS}=0V$
Drain-source breakdown voltage	$V_{(BR)DSS}$	500	—	—	V	$I_D=1mA, V_{GS}=0V$
Zero gate voltage drain current	I_{DSS}	—	—	100	μA	$V_{DS}=500V, V_{GS}=0V$
Gate threshold voltage	$V_{GS(th)}$	2.0	—	4.0	V	$V_{DS}=10V, I_D=1mA$
Static drain-source on-state resistance	$R_{DS(on)}$	—	1.1	1.5	Ω	$I_D=2.5A, V_{GS}=10V$
Forward transfer admittance	$ Y_{fs} $	1.0	3.0	—	S	$I_D=2.5A, V_{DS}=10V$
Input capacitance	C_{iss}	—	600	—	pF	$V_{DS}=10V$
Output capacitance	C_{oss}	—	135	—	pF	$V_{GS}=0V$
Reverse transfer capacitance	C_{rss}	—	52	—	pF	$f=1MHz$
Turn-on delay time	$t_{d(on)}$	—	14	—	ns	$I_D=2.5A, V_{DD}\doteq 150V$
Rise time	t_r	—	15	—	ns	$V_{GS}=10V$
Turn-off delay time	$t_{d(off)}$	—	48	—	ns	$R_L=60\Omega$
Fall time	t_f	—	30	—	ns	$R_G=10\Omega$
Reverse recovery time	t_{rr}	—	420	—	ns	$I_{DR}=5A, V_{GS}=0V$
Reverse recovery charge	Q_{rr}	—	2.6	—	μC	$di/dt=100A/\mu s$

●Electrical characteristic curves

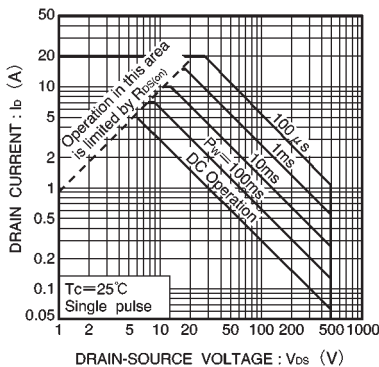

Fig.1 Maximum safe operating area

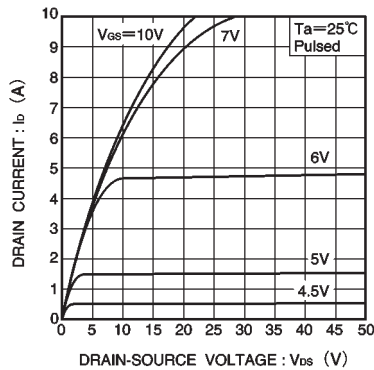

Fig.2 Typical output characteristics

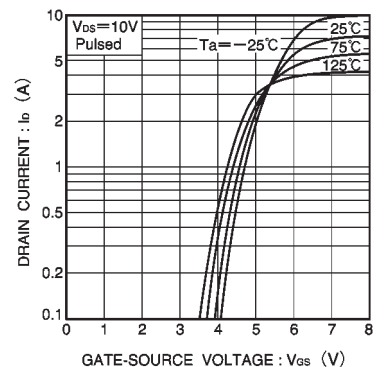

Fig.3 Typical transfer characteristics

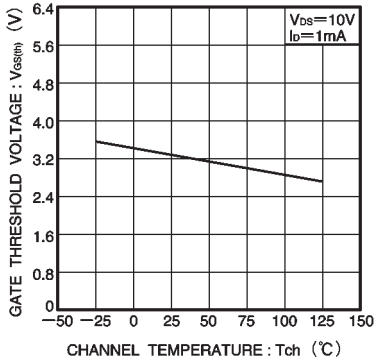

Fig.4 Gate threshold voltage vs. channel temperature

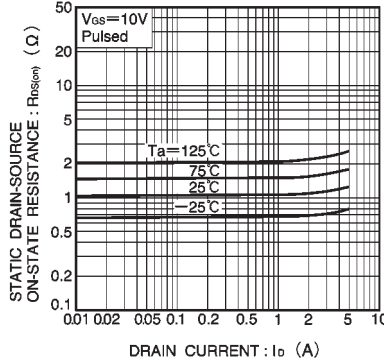

Fig.5 Static drain-source on-state resistance vs. drain current

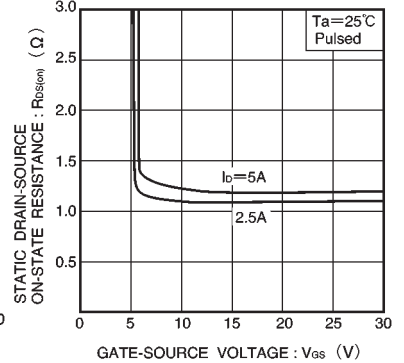

Fig.6 Static drain-source on-state resistance vs. gate-source voltage

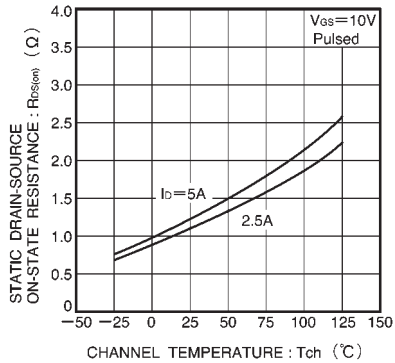

Fig.7 Static drain-source on-state resistance vs. channel temperature

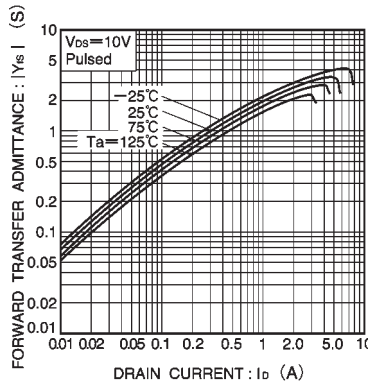

Fig.8 Forward transfer admittance vs. drain current

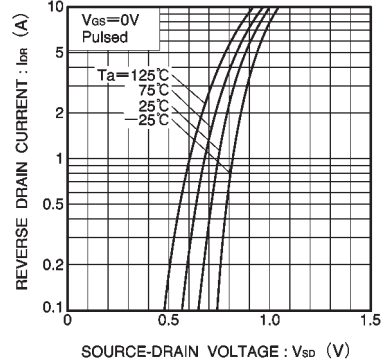

Fig.9 Reverse drain current vs. source-drain voltage (I)

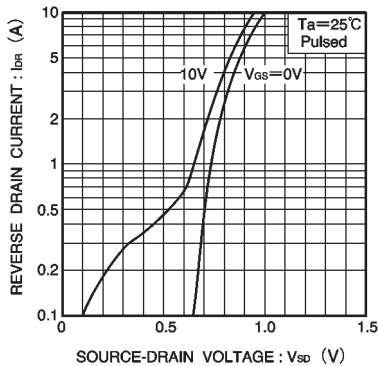

Fig.10 Reverse drain current vs. source-drain voltage (II)

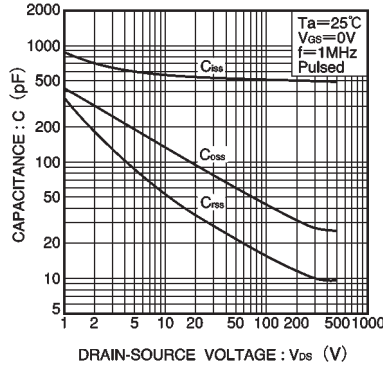

Fig.11 Typical capacitance vs. drain-source voltage

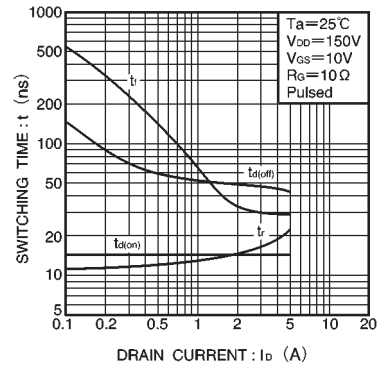

Fig.12 Switching characteristics (See Figures 16 and 17 for the measurement circuit and resultant waveforms)

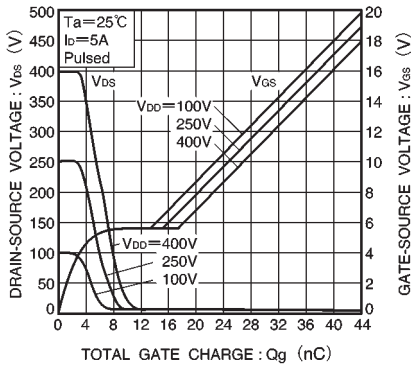

Fig.13 Dynamic input characteristics (See Figure 18 for measurement circuit)

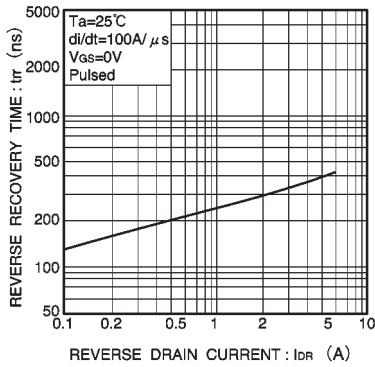

Fig.14 Reverse recovery time vs. reverse drain current

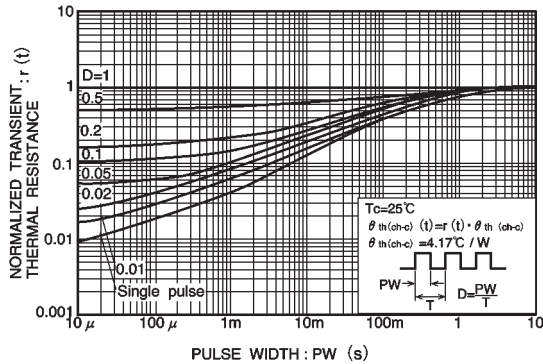

Fig.15 Normalized transient thermal resistance vs. pulse width

● Switching characteristics measurement circuit

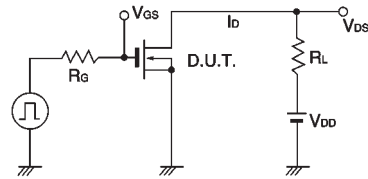

Fig.16 Switching time measurement circuit

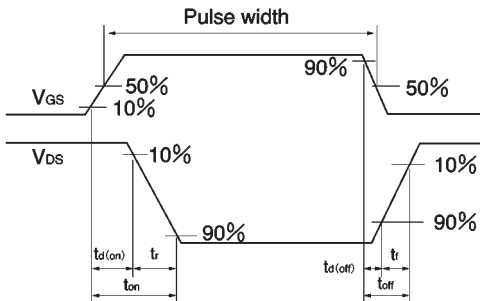

Fig.17 Switching time waveforms

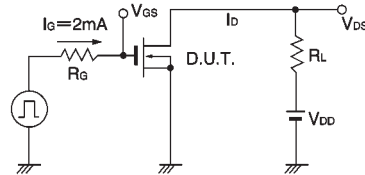

Fig.18 Gate charge measurement circuit