

HIGH VOLTAGE, GENERAL PURPOSE TYPES

DESCRIPTION

The BFX38, BFX39, BFX40 and BFX41 are silicon planar epitaxial PNP transistors in Jedec TO-39 metal case, designed for a wide variety of applications. They are particularly useful as complementary drivers (BFY56A is a good complement) in output and switching applications where high voltage and high current are required.

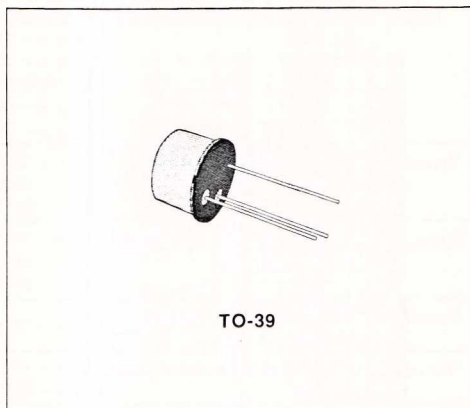

INTERNAL SCHEMATIC DIAGRAM

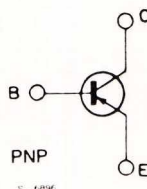

ABSOLUTE MAXIMUM RATINGS

Symbol	Parameter	Value		Unit
		BFX38 BFX39	BFX40 BFX41	
V_{CBO}	Collector-base Voltage ($I_E = 0$)	- 55	- 75	V
V_{CEO}	Collector-emitter Voltage ($I_B = 0$)	- 55	- 75	V
V_{EBO}	Emitter-base Voltage ($I_C = 0$)	- 5		V
I_C	Collector Current	- 1		A
P_{tot}	Total Power Dissipation at $T_{amb} \leq 25^\circ\text{C}$ at $T_{case} \leq 25^\circ\text{C}$	0.8 4		W
T_{stg}, T_J	Storage and Junction Temperature	- 55 to 200		$^\circ\text{C}$

THERMAL DATA

$R_{th\ j-case}$	Thermal Resistance Junction-case	Max	44	$^{\circ}C/W$
$R_{th\ j-amb}$	Thermal Resistance Junction-ambient	Max	219	$^{\circ}C/W$

ELECTRICAL CHARACTERISTICS ($T_{amb} = 25^{\circ}C$ unless otherwise specified)

Symbol	Parameter	Test Conditions	Min.	Typ.	Max.	Unit
I_{CBO}	Collector Cutoff Current ($I_E = 0$)	for BFX38 – BFX39 $V_{CB} = -40\ V$ $V_{CB} = -40\ V$ $T_{amb} = 125^{\circ}C$ for BFX40 – BFX41 $V_{CB} = -50\ V$ $V_{CB} = -50\ V$ $T_{amb} = 125^{\circ}C$		- 0.2 - 0.25	- 50 - 50	nA μA
$V_{(BR)CBO}$	Collector-base Breakdown Voltage ($I_E = 0$)	$I_C = -10\ \mu A$ for BFX38 – BFX39 for BFX40 – BFX41	- 55 - 75			V V
$V_{(BR)CEO}^*$	Collector-emitter Breakdown Voltage ($I_B = 0$)	$I_C = -10\ mA$ for BFX38 – BFX39 for BFX40 – BFX41	- 55 - 75			V V
$V_{(BR)EBO}$	Emitter-base Breakdown Voltage ($I_C = 0$)	$I_E = -10\ \mu A$	- 5			V
$V_{CE(sat)}^*$	Collector-emitter Saturation Voltage	$I_C = -150\ mA$ $I_B = -15\ mA$ $I_C = -500\ mA$ $I_B = -50\ mA$		- 0.12 - 0.3	- 0.15 - 0.5	V V
$V_{BE(sat)}^*$	Base-emitter Saturation Voltage	$I_C = -150\ mA$ $I_B = -15\ mA$ $I_C = -500\ mA$ $I_B = -50\ mA$		- 0.8 - 0.9	- 0.9 - 1.1	V V
h_{FE}^*	DC Current Gain	for BFX38 – BFX40 $I_C = -100\ \mu A$ $V_{CE} = -5\ V$ $I_C = -100\ mA$ $V_{CE} = -5\ V$ $I_C = -500\ mA$ $V_{CE} = -5\ V$ for BFX39 – BFX41 $I_C = -100\ \mu A$ $V_{CE} = -5\ V$ $I_C = -100\ mA$ $V_{CE} = -5\ V$ $I_C = -500\ mA$ $V_{CE} = -5\ V$	60 85 60	90 130 120		
h_{FE}^*	DC Current Gain	$I_C = -1\ A$ $V_{CE} = -5\ V$ for BFX38 for BFX39 for BFX40 for BFX41 $I_C = -100\ mA$ $V_{CE} = -5\ V$ $T_{amb} = -55^{\circ}C$ for BFX38 – BFX40 for BFX39 – BFX41	30 15 25 10			
f_T	Transition Frequency	$I_C = -50\ mA$ $V_{CE} = -10\ V$ $f = 100\ MHz$	100	150		MHz
C_{EBO}	Emitter-base Capacitance	$I_C = 0$ $f = 1\ MHz$ $V_{EB} = -0.5\ V$		75	120	pF
C_{CBO}	Collector-base Capacitance	$I_E = 0$ $f = 1\ MHz$ $V_{CB} = -0.5\ V$		15	20	pF
t_{on}^{**}	Turn-on Time	$I_C = -500\ mA$ $I_{B1} = -50\ mA$ $V_{CC} = -30\ V$		33	100	ns

* Pulsed : pulse duration = 300 μs , duty cycle = 1 %.

** See test circuit.

ELECTRICAL CHARACTERISTICS (continued)

Symbol	Parameter	Test Conditions	Min.	Typ.	Max.	Unit
t_s^{**}	Storage Time	$I_C = -500 \text{ mA}$ $V_{CC} = -30 \text{ V}$ $I_{B1} = I_{B2} = -50 \text{ mA}$		160	350	ns
t_f^{**}	Fall Time	$I_C = -500 \text{ mA}$ $V_{CC} = -30 \text{ V}$ $I_{B1} = -I_{B2} = -50 \text{ mA}$		27	50	ns

DC Current Gain (for BFX38 and BFX40 only).

DC Current Gain (for BFX39 and BFX41 only).

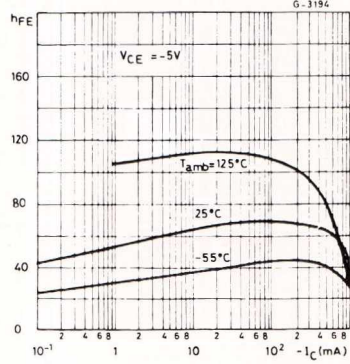
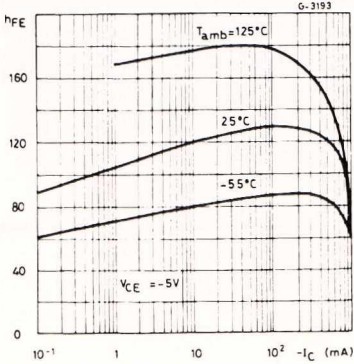

Collector-emitter Saturation Voltage.

Base-emitter Saturation Voltage.

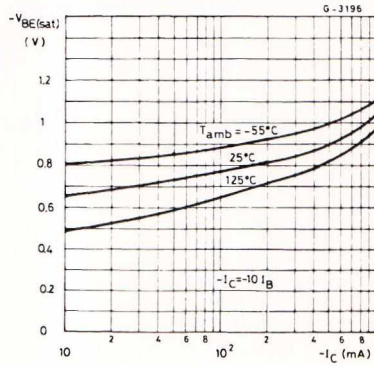
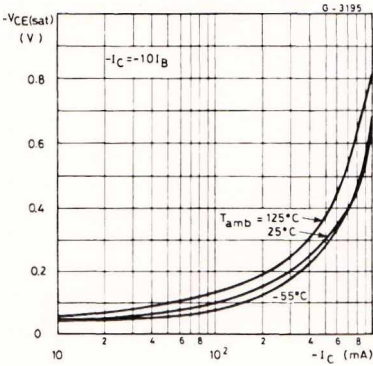

Transition Frequency.

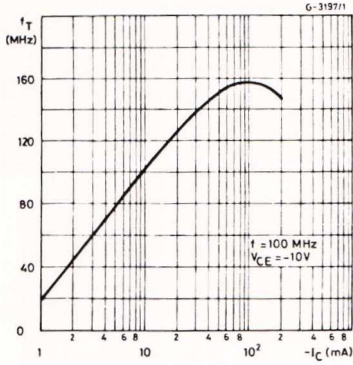

Collector-base Capacitance.

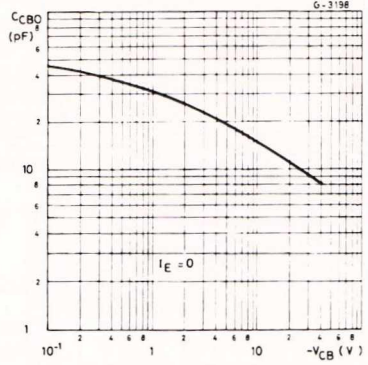

Test Circuit for t_{on} , t_s , and t_r .

