



**HIGH FREQUENCY, HIGH SPEED**

**DESCRIPTION**

The BSX88A is a silicon planar epitaxial NPN transistor specially designed as high speed saturated logic switch. It features 20 Volt,  $V_{CE0}$ , low saturation voltage and fast switching times from 10 to 300mA.



**INTERNAL SCHEMATIC DIAGRAM**

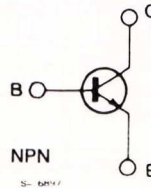

**ABSOLUTE MAXIMUM RATINGS**

Symbol	Parameter	Value	Unit
$V_{CBO}$	Collector-base Voltage ( $I_E = 0$ )	40	V
$V_{CEO}$	Collector-emitter Voltage ( $I_B = 0$ )	20	V
$V_{EBO}$	Emitter-base Voltage ( $I_C = 0$ )	5.5	V
$I_C$	Collector Current	500	mA
$P_{tot}$	Total Power Dissipation at $T_{amb} \leq 25^\circ\text{C}$ at $T_{case} \leq 25^\circ\text{C}$	0.36	W
		1.2	W
$T_{stg}, T_j$	Storage and Junction Temperature	- 55 to 200	$^\circ\text{C}$

**THERMAL DATA**

$R_{th\ j-case}$	Thermal Resistance Junction-case	Max	145	°C/W
$R_{th\ j-amb}$	Thermal Resistance Junction-ambient	Max	486	°C/W

**ELECTRICAL CHARACTERISTICS** ( $T_{amb} = 25\text{ °C}$  unless otherwise specified)

Symbol	Parameter	Test Conditions	Min.	Typ.	Max.	Unit
$I_{CES}$	Collector Cutoff Current ( $V_{EB} = 0$ )	$V_{CE} = 20\text{ V}$			0.3	$\mu\text{A}$
$V_{(BR)CBO}$	Collector-base Breakdown Voltage ( $I_E = 0$ )	$I_C = 100\ \mu\text{A}$	40			V
$V_{(BR)EBO}$	Emitter-base Breakdown Voltage ( $I_C = 0$ )	$I_E = 100\ \mu\text{A}$	5.5			V
$V_{(BR)CEO}^*$	Collector-emitter Breakdown Voltage ( $I_B = 0$ )	$I_C = 10\text{ mA}$	20			V
$V_{CE(sat)}^*$	Collector-emitter Saturation Voltage	$I_C = 10\text{ mA}$ $I_B = 1\text{ mA}$ $I_C = 100\text{ mA}$ $I_B = 10\text{ mA}$			0.18 0.39	V V
$V_{BE(sat)}^*$	Base-emitter Saturation Voltage	$I_C = 10\text{ mA}$ $I_B = 1\text{ mA}$ $I_C = 100\text{ mA}$ $I_B = 10\text{ mA}$	0.72	0.77	0.8 1.2	V V
$h_{FE}^*$	DC Current Gain	$I_C = 0.5\text{ mA}$ $V_{CE} = 1\text{ V}$ $I_C = 10\text{ mA}$ $V_{CE} = 1\text{ V}$ $I_C = 100\text{ mA}$ $V_{CE} = 1\text{ V}$	15 30 35	30 50 55		
$h_{fe}$	High Frequency Current Gain ( $f = 100\text{ MHz}$ )	$I_C = 30\text{ mA}$ $V_{CE} = 10\text{ V}$	3.5	5.8		
$C_{CBO}$	Collector-base Capacitance	$I_E = 0$ $V_{CB} = 0.5\text{ V}$ $f = 1\text{ MHz}$		3	5	pF
$C_{EBO}$	Emitter-base Capacitance	$I_C = 0$ $V_{EB} = 0.5\text{ V}$ $f = 1\text{ MHz}$		7	8	pF
$t_s^{**}$	Change Storage Time Constant	$I_C = I_{B1} = I_{B2} = 10\text{ mA}$			20	ns
$t_{on}^{**}$	Turn-on Time	$I_C = 10\text{ mA}$ $I_{B1} = 3\text{ mA}$ $V_{BE} = -2\text{ V}$			30	ns
$t_{off}^{**}$	Turn-off Time	$I_C = 10\text{ mA}$ $I_{B1} = 3\text{ mA}$ $V_{BE} = -2\text{ V}$			70	ns

\* Pulsed : pulse duration = 300 $\mu\text{s}$ , duty cycle = 1%.

\*\* See test circuit.

**DC Pulse Current Gain vs. Collector Current.**

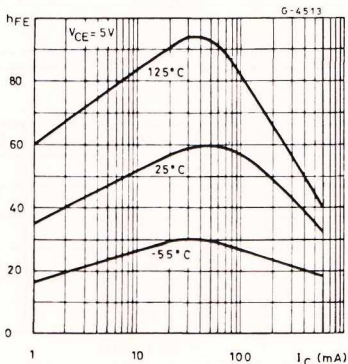

**Collector Saturation Voltage vs. Collector Current.**

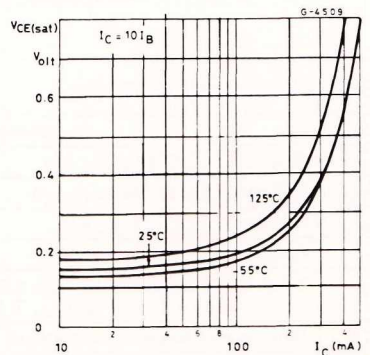

Base Saturation Voltage vs. Collector Current.

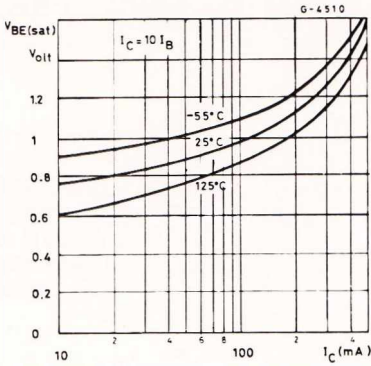

High Frequency Current Gain vs. Collector Current.

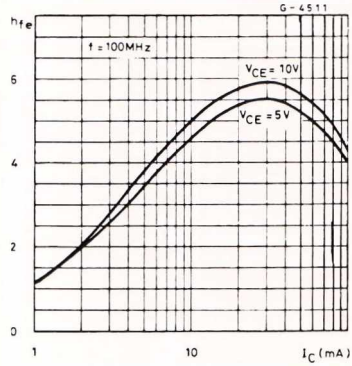

Input and Output Capacitance vs. Reverse Bias Voltage.

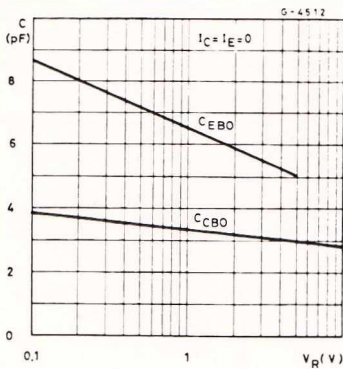

Switching Times vs. Collector Current.

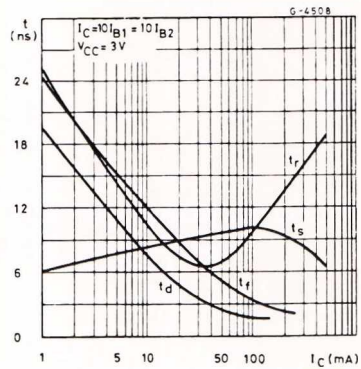

TEST CIRCUITS

Test circuit for  $t_{on}$ ,  $t_{off}$ .

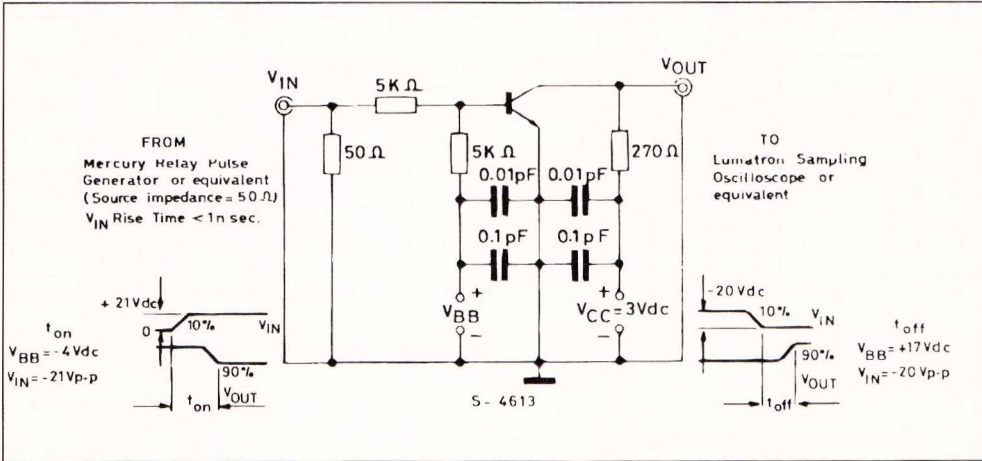

Test circuit for  $t_s$ .

