

## HIGH VOLTAGE POWER DISSIPATION

- HIGH VOLTAGE POWER DARLINGTON
- AUTOMOTIVE IGNITION APPLICATIONS
- HIGH CURRENT

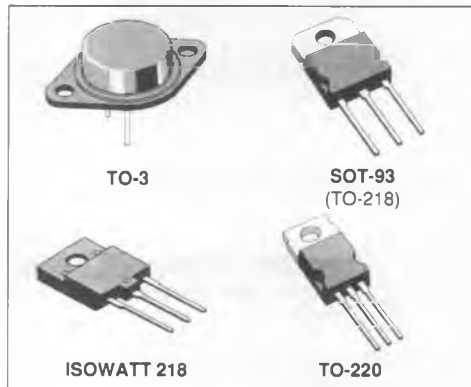

### DESCRIPTION

The BU920/921/922, BU920P/921P/922P, BU920-PFI/BU921PFI/BU922PFI and BU920T/921T/922T are silicon multiepitaxial planar NPN transistors in monolithic darlington configuration mounted respectively in Jedec TO-3 metal case, SOT-93 plastic package, ISOWATT218 fully isolated package and TO-220 plastic package.

They are particularly intended for automotive ignition applications and inverter circuits for motor control.

### INTERNAL SCHEMATIC DIAGRAM

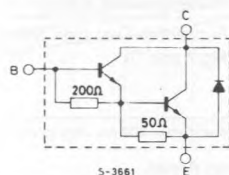

### ABSOLUTE MAXIMUM RATINGS

Symbol	Parameter	Value				Unit
		TO-3 SOT-93 ISOWATT218 TO-220	BU920 BU920P BU920PFI BU920T	BU921 BU921P BU921PFI BU921T	BU922 BU922P BU922PFI BU922T	
$V_{CES}$	Collector-emitter Voltage ( $V_{BE} = 0$ )	400	450	500	V	
$V_{CEO}$	Collector-emitter Voltage ( $I_B = 0$ )	350	400	450	V	
$V_{EBO}$	Emitter-base Voltage ( $I_C = 0$ )	5				V
$I_C$	Collector Current	10				A
$I_{CM}$	Collector Peak Current	15				A
$I_B$	Base Current	5				A
		<b>TO-3</b>	<b>SOT-93</b>	<b>ISOWATT218</b>	<b>TO-220</b>	
$P_{tot}$	Total Dissipation at $T_c \leq 25^\circ\text{C}$	120	105	55	105	W
$T_{stg}$	Storage Temperature - 65 to	175	150	150	150	$^\circ\text{C}$
$T_j$	Max. Operating Junction Temperature	175	150	150	150	$^\circ\text{C}$

**THERMAL DATA**

			<b>TO-3</b>	<b>SOT-93</b>	<b>ISOWATT218</b>	<b>TO-220</b>	
$P_{th(case)}$	Thermal Resistance Junction-case	Max	1.25	1.2	2.27*	1.2	°C/W

**ELECTRICAL CHARACTERISTICS** ( $T_{case} = 25\text{ °C}$  unless otherwise specified)

Symbol	Parameter	Test Conditions	Min.	Typ.	Max.	Unit
$I_{CES}$	Collector Cutoff Current ( $V_{BE} = 0$ )	$V_{CE} = 400\text{ V}$ for <b>920 Types</b> $V_{CE} = 450\text{ V}$ for <b>921 Types</b> $V_{CE} = 500\text{ V}$ for <b>922 Types</b> $V_{CE} = 400\text{ V}$ for <b>920 Types</b> $V_{CE} = 450\text{ V}$ for <b>921 Types</b> $V_{CE} = 500\text{ V}$ for <b>922 Types</b> $T_c = 150\text{ °C}$			250 250 250 0.5 0.5 0.5	$\mu\text{A}$ $\mu\text{A}$ $\mu\text{A}$ $\text{mA}$ $\text{mA}$ $\text{mA}$
$I_{CEO}$	Collector Cutoff Current ( $I_B = 0$ )	$V_{CE} = 350\text{ V}$ for <b>920 Types</b> $V_{CE} = 400\text{ V}$ for <b>921 Types</b> $V_{CE} = 450\text{ V}$ for <b>922 Types</b>			250 250 250	$\mu\text{A}$ $\mu\text{A}$ $\mu\text{A}$
$I_{EBO}$	Emitter Cutoff Current ( $I_C = 0$ )	$V_{EB} = 5\text{ V}$			50	$\text{mA}$
$V_{CEO(sus)}^*$	Collector-emitter Sustaining Voltage	$I_C = 100\text{ mA}$	350 400 450			V V V
$V_{CE(sat)}^*$	Collector-emitter Saturation Voltage	$I_C = 5\text{ A}$ $I_B = 50\text{ mA}$ $I_C = 7\text{ A}$ $I_B = 140\text{ mA}$			1.8 1.8	V V
$V_{BE(sat)}^*$	Base-emitter Saturation Voltage	$I_C = 5\text{ A}$ $I_B = 50\text{ mA}$ $I_C = 7\text{ A}$ $I_B = 140\text{ mA}$			2.2 2.5	V V
$V_F$	Diode Forward Voltage	$I_F = 7\text{ A}$			2.5	V
	Functional Test (see test circuit Fig.2 and 3)	for <b>920 Types</b> $V_{CE} = 350\text{ V}$ $L = 7\text{ mH}$ for <b>921 and 922 Types</b> $V_{CE} = 400\text{ V}$ $L = 7\text{ mH}$	7 7			A A

\* Pulsed : pulse duration = 300  $\mu\text{s}$ , duty cycle = 1.5 %.

**Safe Operating Areas.**

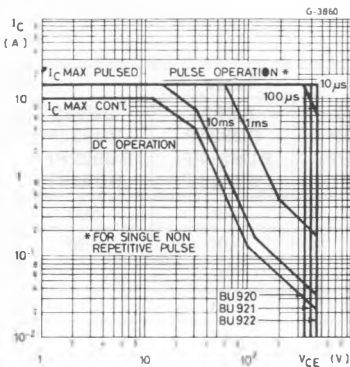

**Safe Operating Areas.**

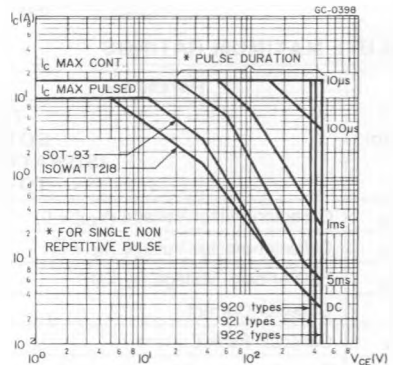

DC Current Gain.

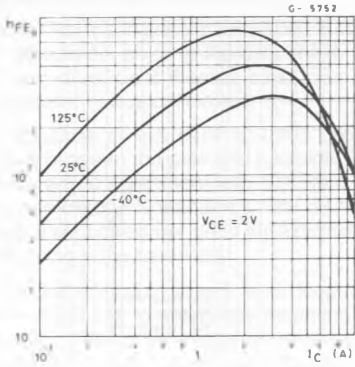

Collector-emitter Saturation Voltage.

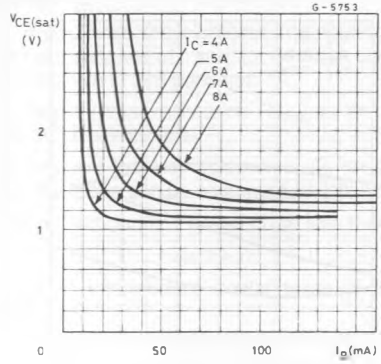

Collector-emitter Saturation Voltage.

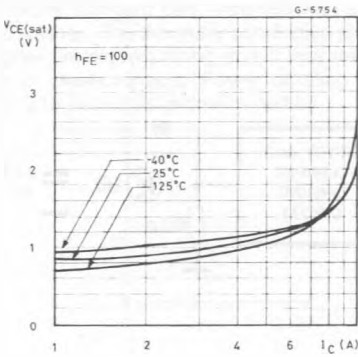

Base-emitter Saturation Voltage.

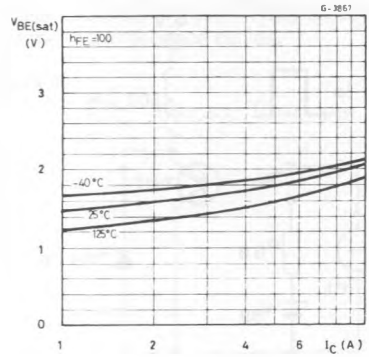

Collector-emitter Saturation Voltage.

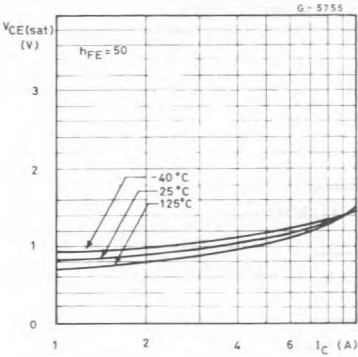

Base-emitter Saturation Voltage.

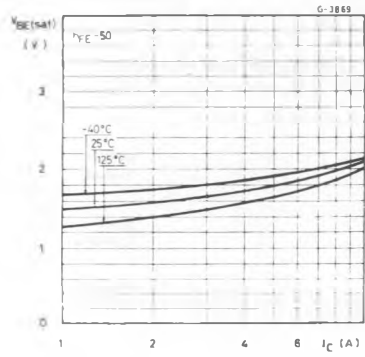

Saturated Switching Characteristics.

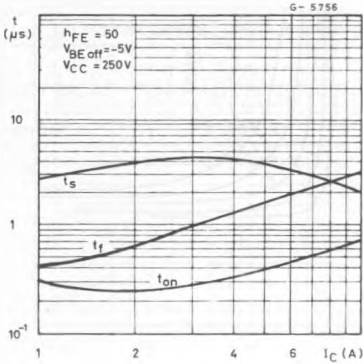
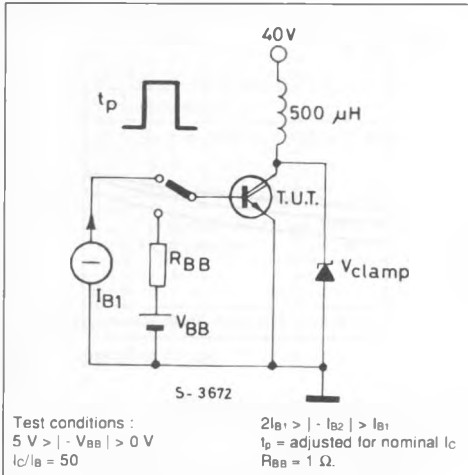

Figure 1 : Clamped  $E_{S/0}$  Test Circuit.



Clamped Reverse Bias Safe Operating Areas.

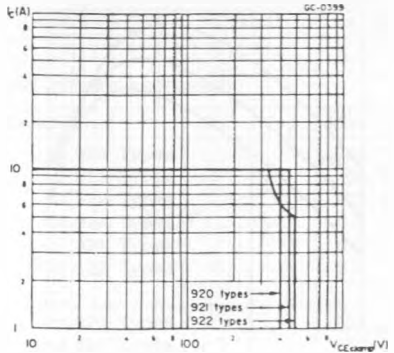

Figure 2 : Functional Test Circuit.

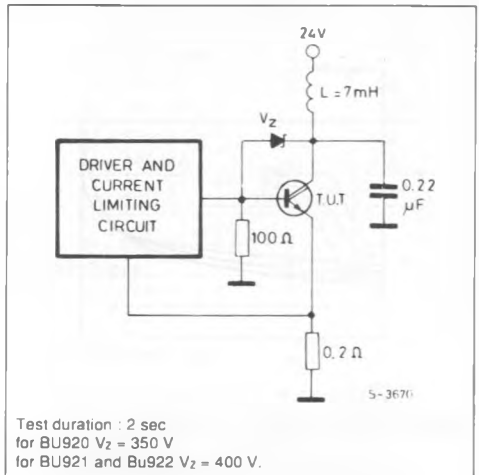
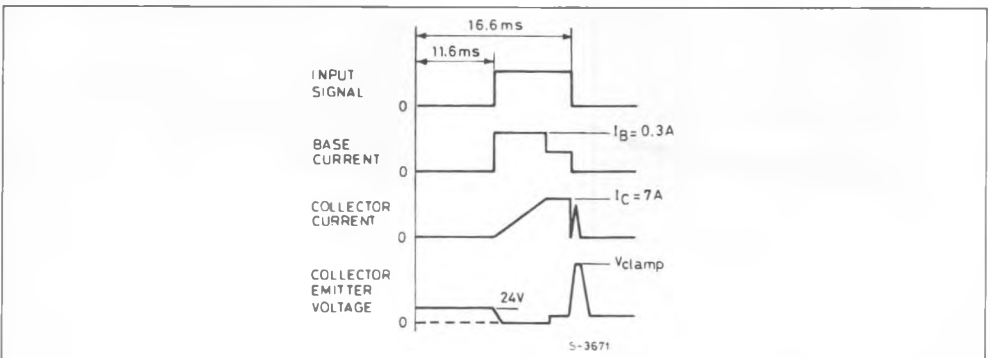

Figure 3 : Functional Test Waveforms.



## ISOWATT 218 PACKAGE CHARACTERISTICS AND APPLICATION

ISOWATT218 is fully isolated to 4000 V dc. Its thermal impedance, given in the data sheet, is optimized to give efficient thermal conduction together with excellent electrical isolation.

The structure of the case ensures optimum distances between the pins and heatsink. These distances are in agreement with VDE and UL creepage and clearance standards. The ISOWATT218 package eliminates the need for external isolation so reducing fixing hardware.

The package is supplied with leads longer than the standard TO-218 to allow easy mounting on pcbs. Accurate moulding techniques used in manufacture assures consistent heat spreader-to-heatsink capacitance.

ISOWATT218 thermal performance is better than that of the standard part, mounted with a 0.1 mm mica washer. The thermally conductive plastic has a higher breakdown rating and is less fragile than mica or plastic sheets. Power derating for ISOWATT218 packages is determined by :

$$P_D = \frac{T_j - T_c}{R_{th}}$$

## THERMAL IMPEDANCE OF ISOWATT 218 PACKAGE

Fig. 4 illustrates the elements contributing to the thermal resistance of transistor heatsink assembly, using ISOWATT218 package.

The total thermal resistance  $R_{th(tot)}$  is the sum of each of these elements.

The transient thermal impedance,  $Z_{th}$  for different pulse durations can be estimated as follows :

1 - for a short duration power pulse less than 1 ms ;

$$Z_{th} = R_{thJ-C}$$

2 - for an intermediate power pulse of 5 ms to 50 ms :

$$Z_{th} = R_{thJ-C}$$

3 - for long power pulses of the order of 500 ms or greater :

$$Z_{th} = R_{thJ-C} + R_{thC-HS} + R_{thHS-amb}$$

It is often possible to discern these areas on transient thermal impedance curves.

Figure 4.

