

FASTSWITCH EASY-TO-DRIVE (ETD) NPN TRANSISTORS

PRELIMINARY DATA

- HIGH SWITCHING SPEED NPN POWER TRANSISTORS
- EASY TO DRIVE
- HIGH VOLTAGE FOR OFF-LINE APPLICATIONS
- 100KHz SWITCHING SPEED
- LOW COST DRIVE CIRCUITS
- LOW DYNAMIC SATURATION

APPLICATIONS

- SMPS
- MOTOR DRIVES

DESCRIPTION

These Easy-to-Drive FASTSWITCH NPN power transistors are specially designed for high reliability

industrial and professional power driving applications such as motor drives and off-line switching power supplies. ETD transistors will operate using easy drive circuits at up to 100KHz ; this helps to simplify designs and improve reliability. The superior switching performance and low crossover losses reduce dissipation and consequently lower the equipment operating temperature. These ETD transistors are suitable for application in high power, high reliability, motor drives and half bridge and full bridge converters.

These Easy-To-Drive FASTSWITCH transistors are available in TO-218 and TO-3 packages. Additionally, the alumina isolated version is available in the TOP-3I package.

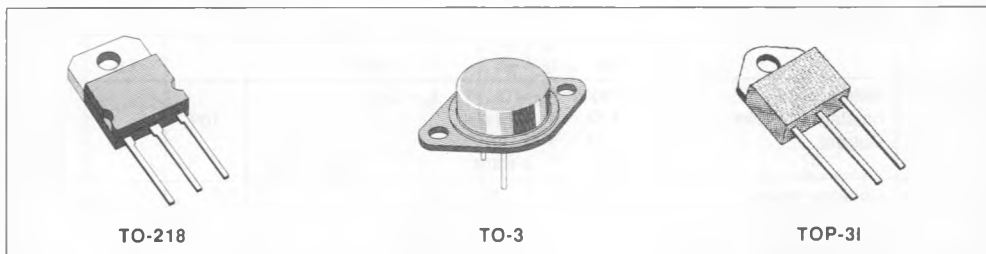

ABSOLUTE MAXIMUM RATINGS

| Symbol | Parameter | TO-218 TOP-3I TO-3 | Value | | | Unit |
|-----------|--|--------------------------|------------------------------|---------------|---------------------------------|------------|
| | | | BUF420 BUF420I BUF420M | TO-218 | BUF420A BUF420AI BUF420AM | |
| V_{CEV} | Collector-emitter Voltage ($V_{BE} = -1.5V$) | | 850 | | 1000 | V |
| V_{CEO} | Collector-emitter Voltage ($I_B = 0$) | | | 450 | | V |
| V_{EBO} | Emitter-base Voltage ($I_C = 0$) | | | 7 | | V |
| I_C | Collector Current | | | 30 | | A |
| I_{CM} | Collector Peak Current | | | 60 | | A |
| I_B | Base Current | | | 6 | | A |
| I_{BM} | Base Peak Current | | | 9 | | A |
| | | | TO-3 | TO-218 | TOP-3I | |
| P_{tot} | Total Dissipation at $T_C < 25^\circ C$ | | 200 | 200 | 115 | W |
| T_{stg} | Storage Temperature | | - 65 to 150 | | | $^\circ C$ |
| T_J | Max. Operating Junction Temperature | | 150 | | | $^\circ C$ |

THERMAL DATA

| | | | TO-3 | TO-218 | TOP-31 | |
|-----------------|----------------------------------|-----|------|--------|--------|------|
| $R_{thj\ case}$ | Thermal Resistance Junction-case | Max | 0.63 | 0.63 | 1.09 | °C/W |

ELECTRICAL CHARACTERISTICS ($T_J = 25^\circ\text{C}$ unless otherwise specified)

| Symbol | Parameter | Test Conditions | Min. | Typ. | Max. | Unit |
|------------------------|---|--|-----------|------|------|--|
| I_{CEr} | Collector Cutoff Current ($R_{BE} = 5\Omega$) | $V_{CE} = V_{CEV}$ | | | 0.2 | mA |
| | | $V_{CE} = V_{CEV}$ $T_c = 100^\circ\text{C}$ | | | 1 | mA |
| I_{CEV} | Collector Cutoff Current | $V_{CE} = V_{CEV}$ $V_{BE} = -1.5\text{V}$ | | | 0.2 | mA |
| | | $V_{CE} = V_{CEV}$ $V_{BE} = -1.5\text{V}$ $T_c = 100^\circ\text{C}$ | | | 1 | mA |
| I_{EBO} | Emitter Cutoff Current ($I_C = 0$) | $V_{EB} = 5\text{V}$ | | | 1 | mA |
| $V_{CEO(sus)}$ * | Collector Emitter Sustaining Voltage | $I_C = 0.2\text{A}$ $L = 25\text{mH}$ | 450 | | | V |
| V_{EBO} | Emitter-base Voltage ($I_C = 0$) | $I_E = 50\text{mA}$ | 7 | | | V |
| $V_{CE(sat)}$ * | Collector-emitter Saturation Voltage | $I_C = 10\text{A}$ $I_B = 1\text{A}$ | | 0.8 | | V |
| | | $I_C = 10\text{A}$ $I_B = 1\text{A}$ $T_c = 100^\circ\text{C}$ | | | 2.8 | V |
| | | $I_C = 20\text{A}$ $I_B = 4\text{A}$ | | 0.5 | | V |
| | | $I_C = 20\text{A}$ $I_B = 4\text{A}$ $T_c = 100^\circ\text{C}$ | | | 2 | V |
| $V_{BE(sat)}$ * | Base-emitter Saturation Voltage | $I_C = 10\text{A}$ $I_B = 1\text{A}$ | | 0.9 | | V |
| | | $I_C = 10\text{A}$ $I_B = 1\text{A}$ $T_c = 100^\circ\text{C}$ | | | 1.5 | V |
| | | $I_C = 20\text{A}$ $I_B = 4\text{A}$ | | 1.1 | | V |
| | | $I_C = 20\text{A}$ $I_B = 4\text{A}$ $T_c = 100^\circ\text{C}$ | | | 1.5 | V |
| di_C/dt | Rate of Rise of on-state Collector Current | $V_{CC} = 300\text{V}$ $R_C = 0$ $t_p = 3\mu\text{s}$ $I_{B1} = 1.5\text{A}$ $T_J = 25^\circ\text{C}$ $I_{B1} = 1.5\text{A}$ $T_J = 100^\circ\text{C}$ $I_{B1} = 6\text{A}$ $T_J = 100^\circ\text{C}$ | 70 150 | 100 | | A/ μs A/ μs A/ μs |
| $V_{CE(3\mu\text{s})}$ | Collector-emitter Dynamic Voltage | $V_{CC} = 300\text{V}$ $R_C = 30\Omega$ $I_{B1} = 1.5\text{A}$ $T_J = 25^\circ\text{C}$ $T_J = 100^\circ\text{C}$ | | 2.1 | 8 | V V |
| $V_{CE(5\mu\text{s})}$ | Collector-emitter Dynamic Voltage | $V_{CC} = 300\text{V}$ $R_C = 30\Omega$ $I_{B1} = 1.5\text{A}$ $T_J = 25^\circ\text{C}$ $T_J = 100^\circ\text{C}$ | | 1.1 | 4 | V V |
| t_s | Storage Time | $I_C = 10\text{A}$ $V_{CC} = 50\text{V}$ $V_{BB} = -5\text{V}$ $R_{BB} = 0.6\Omega$ $V_{clamp} = 400\text{V}$ $I_{B1} = 1\text{A}$ $L = 0.25\text{mH}$ | | 1 | | μs |
| t_f | Fall Time | | | 0.05 | | μs |
| t_c | Cross Over Time | | | 0.08 | | μs |
| t_s | Storage Time | $I_C = 10\text{A}$ $V_{CC} = 50\text{V}$ $V_{BB} = -5\text{V}$ $R_{BB} = 0.6\Omega$ $V_{clamp} = 400\text{V}$ $I_{B1} = 1\text{A}$ $L = 0.25\text{mH}$ $T_J = 100^\circ\text{C}$ | | | 2 | μs |
| t_f | Fall Time | | | | 0.1 | μs |
| t_c | Cross Over Time | | | | 0.18 | μs |
| V_{CEW} | Maximum Collector Emitter Voltage without Snubber | $I_C = 10\text{A}$ $V_{CC} = 50\text{V}$ $V_{BB} = -5\text{V}$ $R_{BB} = 0.6\Omega$ $V_{clamp} = 400\text{V}$ $I_{B1} = 1\text{A}$ $L = 0.25\text{mH}$ $T_J = 125^\circ\text{C}$ | 500 | | | V |
| t_s | Storage Time | $I_C = 10\text{A}$ $V_{CC} = 50\text{V}$ $V_{BB} = 0$ $R_{BB} = 0.15\Omega$ $V_{clamp} = 400\text{V}$ $I_{B1} = 1\text{A}$ $L = 0.25\text{mH}$ | | 1.5 | | μs |
| t_f | Fall Time | | | 0.04 | | μs |
| t_c | Cross Over Time | | | 0.07 | | μs |

ELECTRICAL CHARACTERISTICS (continued)

| Symbol | Parameter | Test Conditions | | Min. | Typ. | Max. | Unit |
|-----------|---|--------------------------|-----------------------|------|------|------|---------|
| t_s | Storage Time | $I_C = 10A$ | $V_{CC} = 50V$ | | | 3 | μs |
| t_f | Fall Time | $V_{BB} = 0$ | $R_{BB} = 0.15\Omega$ | | | 0.15 | μs |
| t_c | Cross Over Time | $V_{clamp} = 400V$ | $I_{B1} = 1A$ | | | 0.25 | μs |
| | | $L = 0.25mH$ | $T_j = 100^\circ C$ | | | | |
| V_{CEW} | Maximum Collector Emitter Voltage without Snubber | $I_C = 10A$ | $V_{CC} = 50V$ | 500 | | | V |
| | | $V_{BB} = 0$ | $R_{BB} = 0.15\Omega$ | | | | |
| | | $V_{clamp} = 400V$ | $I_{B1} = 1A$ | | | | |
| | | $L = 0.25mH$ | $T_j = 125^\circ C$ | | | | |
| t_s | Storage Time | $I_C = 20A$ | $V_{CC} = 50V$ | | 2.2 | | μs |
| t_f | Fall Time | $V_{BB} = -5V$ | $R_{BB} = 0.6\Omega$ | | 0.06 | | μs |
| t_c | Cross Over Time | $V_{clamp} = 400V$ | $I_{B1} = 4A$ | | 0.12 | | μs |
| | | $L = 0.12mH$ | | | | | |
| t_s | Storage Time | $I_C = 20A$ | $V_{CC} = 50V$ | | | 3.5 | μs |
| t_f | Fall Time | $V_{BB} = -5V$ | $R_{BB} = 0.6\Omega$ | | | 0.12 | μs |
| t_c | Cross Over Time | $V_{clamp} = 400V$ | $I_{B1} = 4A$ | | | 0.3 | μs |
| | | $L = 0.12mH$ | $T_j = 125^\circ C$ | | | | |
| V_{CEW} | Maximum Collector Emitter Voltage without Snubber | $I_{C\text{Woff}} = 30A$ | $V_{CC} = 50V$ | 400 | | | V |
| | | $V_{BB} = -5V$ | $R_{BB} = 0.6\Omega$ | | | | |
| | | $L = 0.08mH$ | | | | | |
| | | $T_j = 125^\circ C$ | | | | | |

Turn-on Switching Test Circuit.

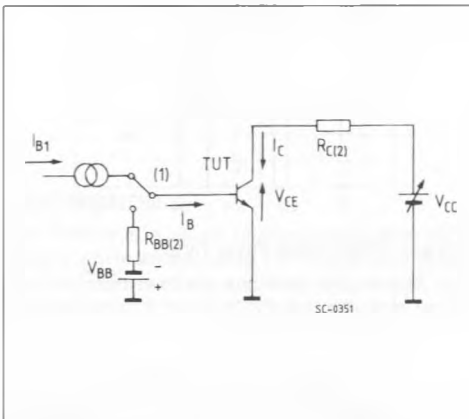

- (1) Fast electronic switch
- (2) Non-inductive Resistor

Turn-off Switching Test Circuit.

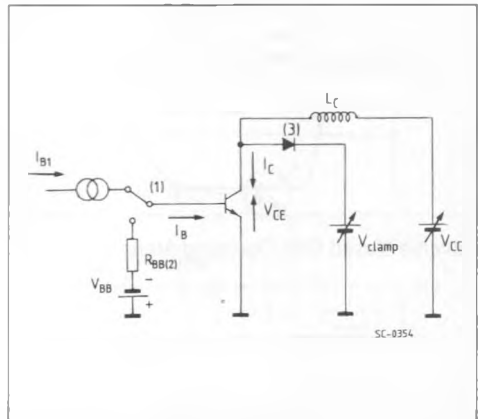

- (1) Fast electronic switch
- (2) Non-inductive Resistor
- (3) Fast recovery rectifier

Turn-on Switching Test Waveforms.

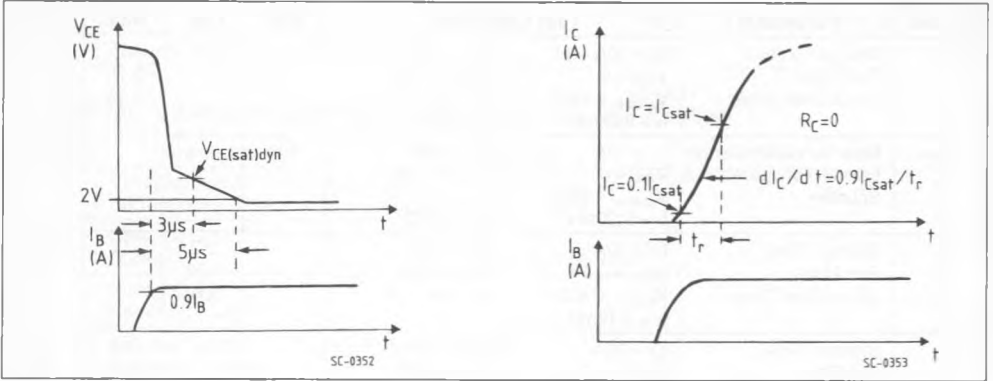

Turn-off Switching Waveforms (inductive load).

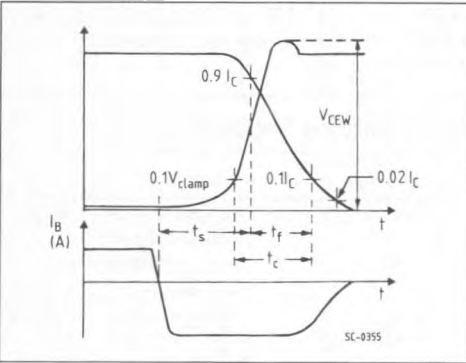

Forward Biased Safe Operating Areas.

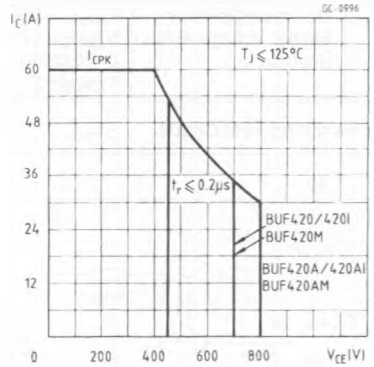

Reverse Biased Safe Operating Areas.

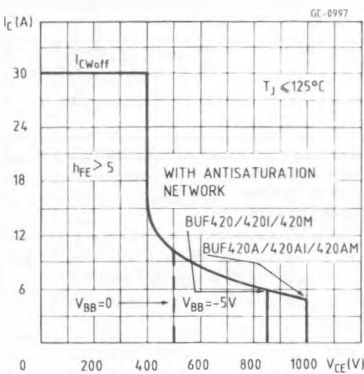

Storage Time Versus Pulse Time.

