

## HIGH VOLTAGE POWER SWITCH

### DESCRIPTION

The BUX48/A, BUV48/A, and BUV48FI/AFI are multi-epitaxial mesa NPN transistors mounted respectively in TO-3 metal case, TO-218 plastic package and ISOWATT218 fully isolated package.

They are particularly intended for switching applications directly from the 220V and 380V mains.

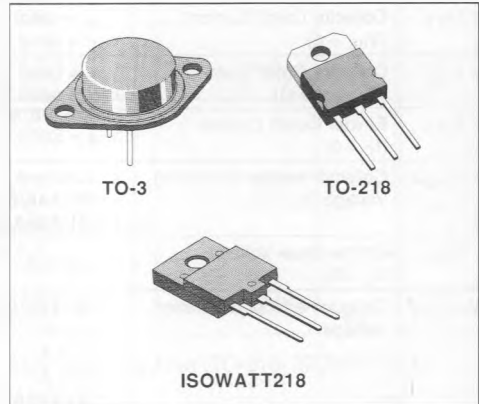

### INTERNAL SCHEMATIC DIAGRAM

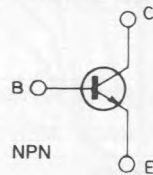

### ABSOLUTE MAXIMUM RATINGS

Symbol	Parameter	Value			Unit
		BUX48 BUV48 BUV48FI	TO-218	BUX48A BUV48A BUV48AFI	
$V_{CER}$	Collector-emitter Voltage ( $R_{BE} = 10 \Omega$ )	850		1000	V
$V_{CES}$	Collector-emitter Voltage ( $V_{BE} = 0$ )	850		1000	V
$V_{CEO}$	Collector-emitter Voltage ( $I_B = 0$ )	400		450	V
$V_{EBO}$	Emitter-base Voltage ( $I_C = 0$ )		7		V
$I_C$	Collector Current		15		A
$I_{CM}$	Collector Peak Current ( $t_D < 5$ ms)		30		A
$I_{CP}$	Collector Peak Current non Repetitive ( $t_D < 20$ $\mu$ s)		55		A
$I_B$	Base Current		4		A
$I_{BM}$	Base Peak Current		20		A
		TO-3	TO-218	ISOWATT218	
$P_{tot}$	Total Dissipation at $T_C < 25^\circ\text{C}$	175	125	65	W
$T_{stg}$	Storage Temperature	- 65 to 200	- 65 to 150	- 65 to 150	$^\circ\text{C}$
$T_J$	Max. Operating Junction Temperature	200	125	125	$^\circ\text{C}$

**THERMAL DATA**

			TO-3	TO-218	ISOWATT218	
$R_{th\ j\ case}$	Thermal Resistance Junction-case	max	1	1	1.92	°C/W

**ELECTRICAL CHARACTERISTICS** ( $T_{case} = 25\text{ °C}$  unless otherwise specified)

Symbol	Parameter	Test Conditions	Min.	Typ.	Max.	Unit
$I_{CES}$	Collector Cutoff Current ( $V_{BE} = 0$ )	$V_{CE} = \text{rated } V_{CES}$ $V_{CE} = \text{rated } V_{CES}, T_c = 125\text{ °C}$			200 2	$\mu\text{A}$ mA
$I_{CER}$	Collector Cutoff Current ( $R_{BE} = 10\ \Omega$ )	$V_{CE} = \text{rated } V_{CER}$ $V_{CE} = \text{rated } V_{CER}, T_c = 125\text{ °C}$			500 4	$\mu\text{A}$ mA
$I_{EBO}$	Emitter Cutoff Current ( $I_C = 0$ )	$V_{EB} = 5\text{ V}$			1	mA
$V_{CEO(sus)}$	Collector-emitter Sustaining Voltage ( $I_B = 0$ )	$I_C = 200\text{ mA}$ $L = 25\text{ mH}$ for <b>BUX48/BUV48/BUV48FI</b> for <b>BUX48A/BUV48A/BUV48AFI</b>	400 450			V V
$V_{EBO}$	Emitter-base Voltage ( $I_C = 0$ )	$I_E = 50\text{ mA}$	7		30	V
$V_{CE(sat)}^*$	Collector-emitter Saturation Voltage	for <b>BUX48/BUV48/BUV48FI</b> $I_C = 10\text{ A}$ $I_B = 2\text{ A}$ $I_C = 15\text{ A}$ $I_B = 4\text{ A}$ $I_C = 15\text{ A}$ $I_B = 3\text{ A}$ for <b>BUX48A/BUV48A/BUV48AFI</b> $I_C = 8\text{ A}$ $I_B = 1.6\text{ A}$ $I_C = 12\text{ A}$ $I_B = 2.4\text{ A}$			1.5 3.5 5 1.5 5	V V V V V
$V_{BE(sat)}$	Base-emitter Saturation voltage	for <b>BUX48/BUV48/BUV48FI</b> $I_C = 10\text{ A}$ $I_B = 2\text{ A}$ for <b>BUX48A/BUV48A/BUV48AFI</b> $I_C = 8\text{ A}$ $I_B = 1.6\text{ A}$			1.6 1.6	V V

\* Pulsed : pulse duration = 300  $\mu\text{s}$ , duty cycle  $\leq 2\%$ .

**RESISTIVE SWITCHING TIMES** (see fig. 2)

Symbol	Parameter	Test Conditions	Min.	Typ.	Max.	Unit
$t_{on}$	Turn-on Time	for <b>BUX48/BUV48/BUV48FI</b> $V_{CC} = 150\text{ V}$ $I_C = 10\text{ A}$ $I_{B1} = 2\text{ A}$ for <b>BUX48A/BUV48A/BUV48AFI</b> $V_{CC} = 150\text{ V}$ $I_C = 8\text{ A}$ $I_{B1} = 1.6\text{ A}$			1 1	$\mu\text{s}$ $\mu\text{s}$
$t_s$	Storage Time	for <b>BUX48/BUV48/BUV48FI</b> $V_{CC} = 150\text{ V}$ $I_C = 10\text{ A}$ $I_{B1} = -I_{B2} = 2\text{ A}$ for <b>BUX48A/BUV48A/BUV48AFI</b> $V_{CC} = 150\text{ V}$ $I_C = 8\text{ A}$ $I_{B1} = -I_{B2} = 1.6\text{ A}$			3 3	$\mu\text{s}$ $\mu\text{s}$
$t_f$	Fall Time	for <b>BUX48/BUV48/BUV48FI</b> $V_{CC} = 150\text{ V}$ $I_C = 10\text{ A}$ $I_{B1} = -I_{B2} = 2\text{ A}$ for <b>BUX48A/BUV48A/BUV48AFI</b> $V_{CC} = 150\text{ V}$ $I_C = 8\text{ A}$ $I_{B1} = -I_{B2} = 1.6\text{ A}$			0.8 0.8	$\mu\text{s}$ $\mu\text{s}$

INDUCTIVE SWITCHING TIMES (see fig. 1)

Symbol	Parameter	Test Conditions	Min.	Typ.	Max.	Unit
$t_s$	Storage Time	for <b>BUX48/BUV48/BUV48FI</b> $V_{CC} = 300\text{ V}$ , $I_C = 10\text{ A}$ , $L_B = 3\text{ }\mu\text{H}$ $V_{BE} = -5\text{ V}$ , $I_{B1} = 2\text{ A}$ same $T_{case} = 125\text{ }^\circ\text{C}$		2.7	5	$\mu\text{s}$ $\mu\text{s}$
		for <b>BUX48A/BUV48A/BUV48AFI</b> $V_{CC} = 300\text{ V}$ , $I_C = 8\text{ A}$ , $L_B = 3\text{ }\mu\text{H}$ $V_{BE} = -5\text{ V}$ , $I_{B1} = 1.6\text{ A}$ same, $T_{case} = 125\text{ }^\circ\text{C}$		3	5	$\mu\text{s}$ $\mu\text{s}$
$t_f$	Fall Time	for <b>BUX48/BUV48/BUV48FI</b> $V_{CC} = 300\text{ V}$ , $I_C = 10\text{ A}$ , $L_B = 3\text{ }\mu\text{H}$ $V_{BE} = -5\text{ V}$ , $I_{B1} = 2\text{ A}$ same $T_{case} = 125\text{ }^\circ\text{C}$		0.16	0.4	$\mu\text{s}$ $\mu\text{s}$
		for <b>BUX48A/BUV48A/BUV48AFI</b> $V_{CC} = 300\text{ V}$ , $I_C = 8\text{ A}$ , $L_B = 3\text{ }\mu\text{H}$ $V_{BE} = -5\text{ V}$ , $I_{B1} = 1.6\text{ A}$ same, $T_{case} = 125\text{ }^\circ\text{C}$		0.13	0.4	$\mu\text{s}$ $\mu\text{s}$

Safe Operating Area (TO-3).

Safe Operating Area (TO-218, ISOWATT218).

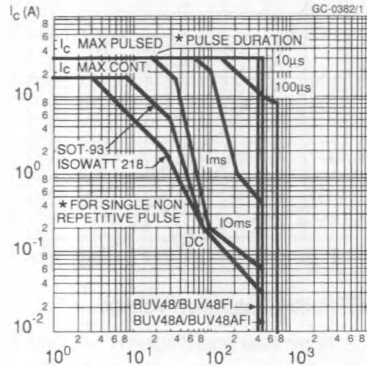
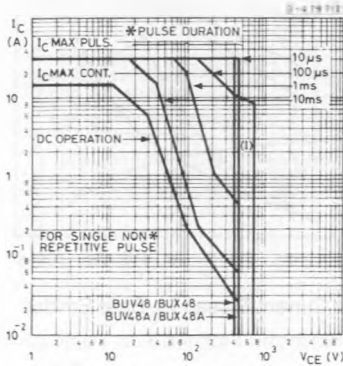

Clamped Reverse Bias Safe Operating Areas.

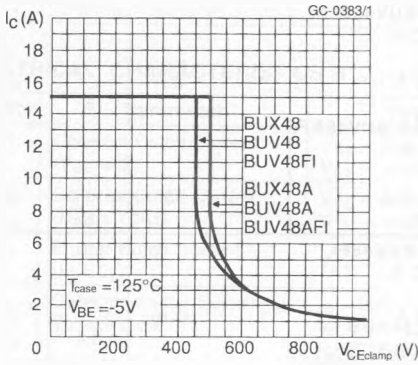

Forward Biased Accidental Overload Area. (see fig. 3).

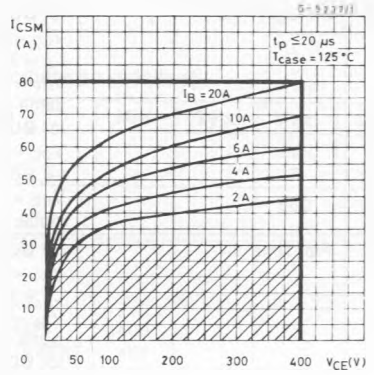

DC Current Gain..

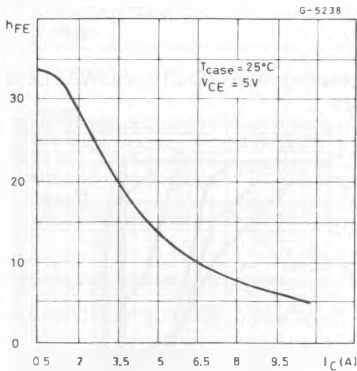

Saturation Voltage.

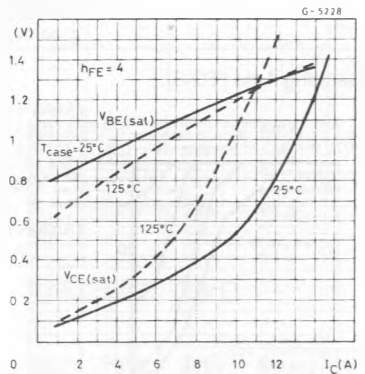

Collector-emitter Saturation Voltage.

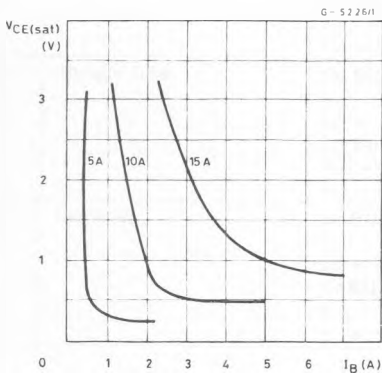

Collector Current Spread vs. Base Emitter Voltage.

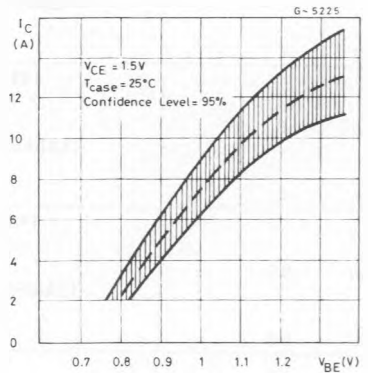

Switching Times vs. Collector Current with  $I_B$  Constant.

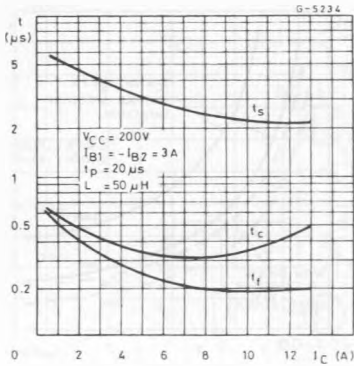

Switching Times Percentage Variation vs. Case Temperature.

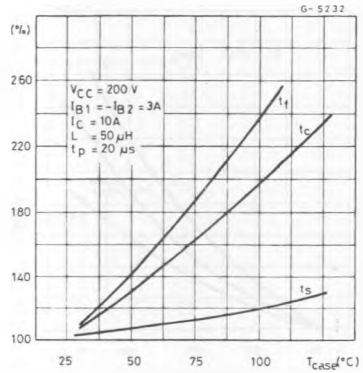

Switching Times with and without Antisaturation Network (see fig.1).

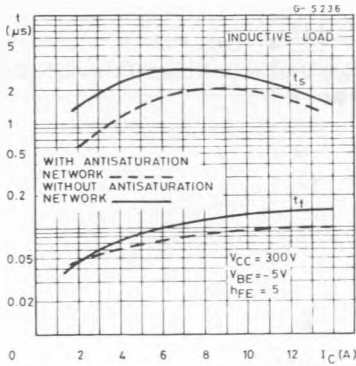

Switching Times Percentage Variation vs. Case Temperature.

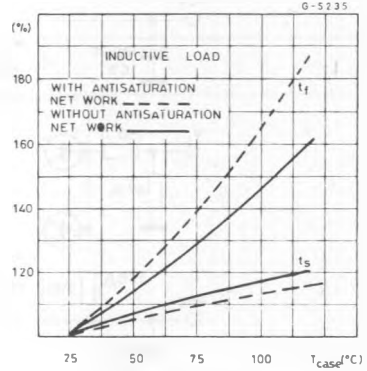

Switching Times vs. Collector Current (see fig.2).

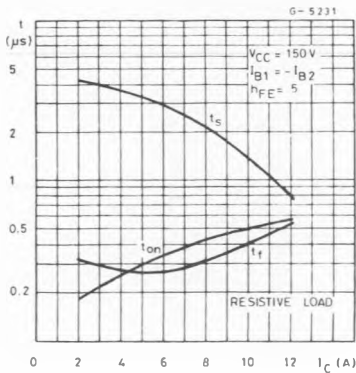

Fall Times vs. Voltage Slope (see fig.2)..

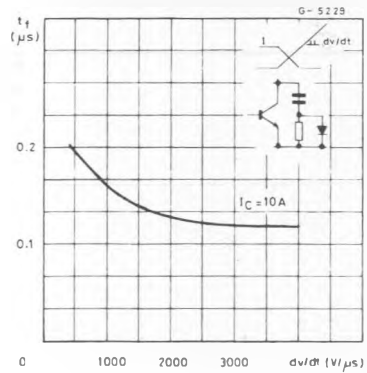

Switching Times Percentage Variation vs. Case Temperature.

Dynamic Collector-emitter Saturation Voltage (see fig. 4).

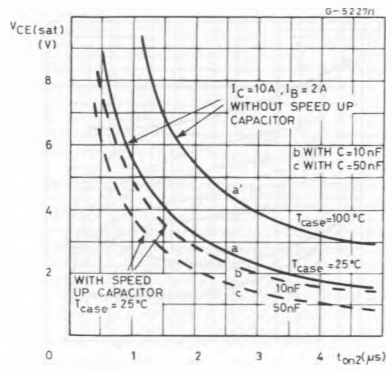
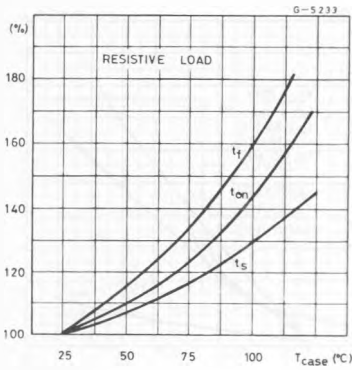
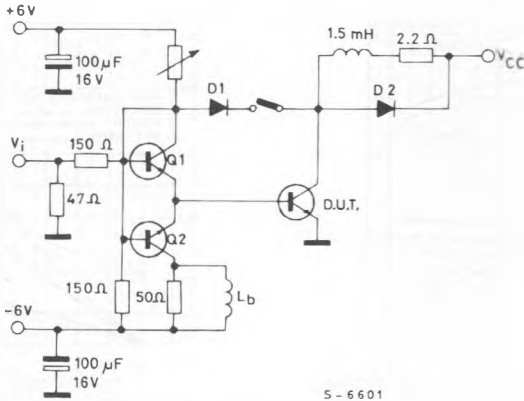

Figure 1 : Switching Times Test Circuit on Inductive Load, with and without Antisaturation Network.



D1, D2 : Fast recovery diodes  
Q1, Q2 : Transistors SGS 2N5191, 2N5195

Figure 2 : Switching Times Test Circuit on resistive Load.

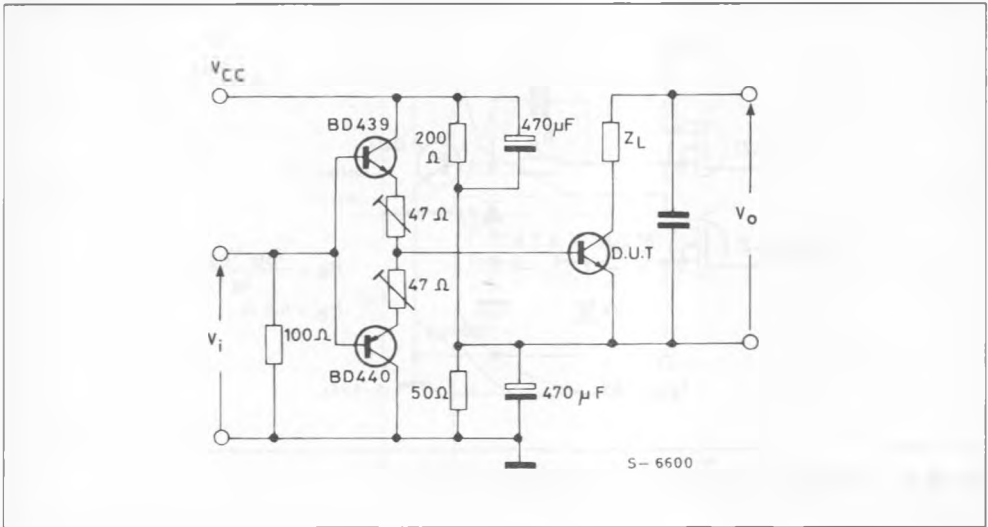

Figure 3 : Forward Biased Accidental Overload Area Test Circuit.

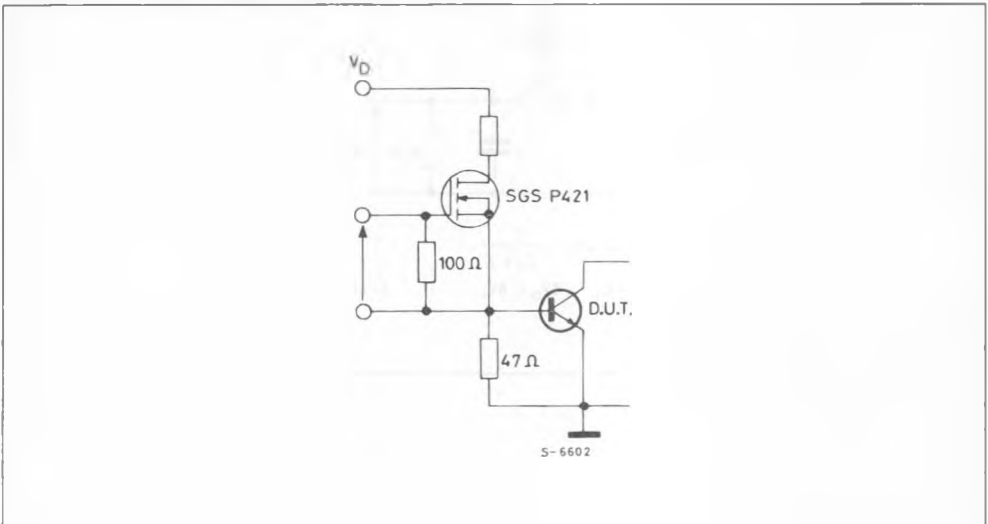

Figure 4 :  $V_{CE(sat)}$  Dyn. Test Circuit.

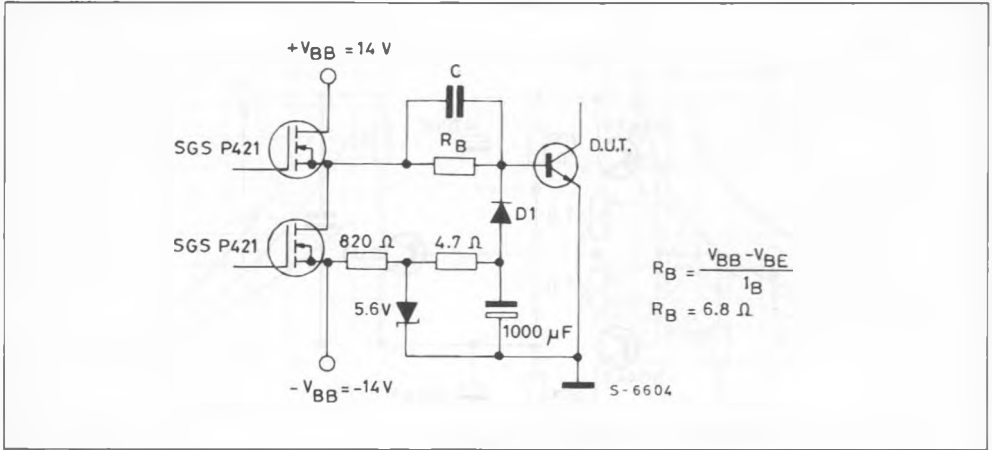

Figure 5 : Equivalent Input Schematic Circuit at Turn-on.

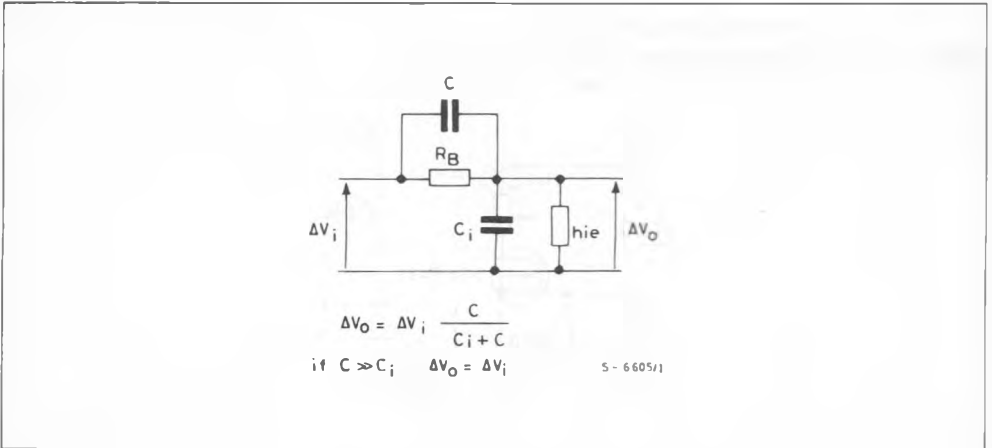
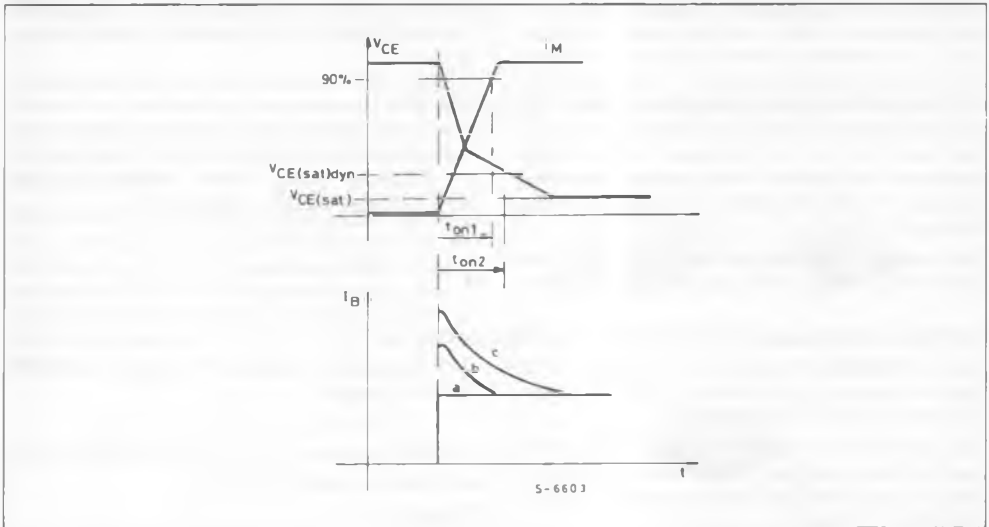



Figure 6 : Remarks to  $V_{CE(sat)}$  Dyn. Test Circuit (fig.4).



The speed-up capacitor decreases the  $V_{CE(sat)}$  dyn. as shown in diagram (figure 6). The 50 nF capacitor modifies the shape of base current with a overshoot.

**ISOWATT218 PACKAGE CHARACTERISTICS AND APPLICATION**

ISOWATT218 is fully isolated to 4000V dc. Its thermal impedance, given in the data sheet, is optimised to give efficient thermal conduction together with excellent electrical isolation. The structure of the case ensures optimum distances between the pins and heatsink. These distances are in agreement with VDE and UL creepage and clearance standards. The ISOWATT218 package eliminates the need for external isolation so reducing fixing hardware.

The package is supplied with leads longer than the standard TO-218 to allow easy mounting on pcbs.

Accurate moulding techniques used in manufacture assures consistent heat spreader-to-heatsink capacitance.

ISOWATT218 thermal performance is equivalent to that of the standard part, mounted with a 0.1 mm mica washer. The thermally conductive plastic has a higher breakdown rating and is less fragile than mica or plastic sheets. Power derating for ISOWATT218 packages is determined by :

$$P_D = \frac{T_j - T_c}{R_{th}}$$

**THERMAL IMPEDANCE OF ISOWATT218 PACKAGE**

Figure 6 illustrates the elements contributing to the thermal resistance of a transistor heatsink assembly, using ISOWATT218 package.

The total thermal resistance  $R_{th(tot)}$  is the sum of each of these elements. The transient thermal impedance,  $Z_{th}$  for different pulse durations can be estimated as follows :

1 - For a short duration power pulse of less than 1ms :

$$Z_{th} < R_{thJ-C}$$

2 - For an intermediate power pulse of 5ms to 50ms seconds :

$$Z_{th} = R_{thJ-C}$$

3 - For long power pulses of the order of 500ms seconds or greater :

$$Z_{th} = R_{thJ-C} + R_{thC-HS} + R_{thHS-amb}$$

It is often possible to discern these areas on transient thermal impedance curves.

**Figure 6.**

