

FAST SWITCHING POWER TRANSISTOR

- FAST SWITCHING TIMES
- LOW SWITCHING LOSSES
- VERY LOW SATURATION VOLTAGE AND HIGH GAIN FOR REDUCED LOAD OPERATION

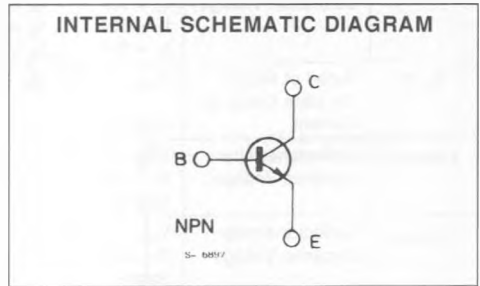
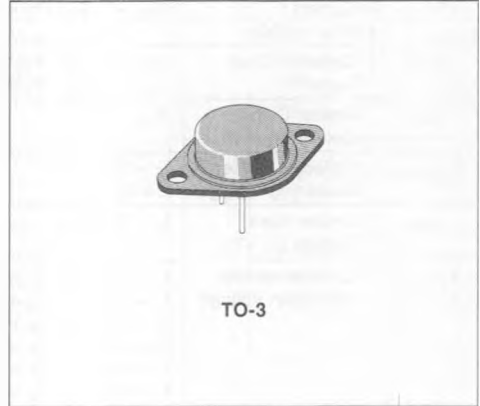

ABSOLUTE MAXIMUM RATINGS

Symbol	Parameter	Value	Unit
V_{CEV}	Collector-emitter Voltage ($V_{BE} = -1.5V$)	250	V
V_{CEO}	Collector-emitter Voltage ($I_B = 0$)	125	V
V_{EBO}	Emitter-base Voltage ($I_C = 0$)	7	V
I_C	Collector Current	50	A
I_{CM}	Collector Peak Current	80	A
I_B	Base Current	10	A
I_{BM}	Base Peak Current	18	A
P_{base}	Reverse Bias Base Dissipation (B.E. junction in avalanche)	3	W
P_{tot}	Total Dissipation at $T_c < 25^\circ C$	250	W
T_{stg}	Storage Temperature	- 65 to 200	$^\circ C$
T_j	Max. Operating Junction Temperature	200	$^\circ C$

THERMAL DATA

R_{thj_case}	Thermal Resistance Junction-case	Max	0.7	°C/W
-----------------	----------------------------------	-----	-----	------

ELECTRICAL CHARACTERISTICS ($T_{case} = 25^{\circ}C$ unless otherwise specified)

Symbol	Parameter	Test Conditions	Min.	Typ.	Max.	Unit
I_{CER}	Collector Cutoff Current ($R_{BE} = 10\Omega$)	$V_{CE} = V_{CEV}$ $V_{CE} = V_{CEV}$ $T_c = 100^{\circ}C$			1 5	mA mA
I_{CEV}	Collector Cutoff Current	$V_{CE} = V_{CEV}$ $V_{BE} = -1.5V$ $V_{CE} = V_{CEV}$ $V_{BE} = -1.5V$ $T_c = 100^{\circ}C$			1 4	mA mA
I_{EBO}	Emitter Cutoff Current ($I_C = 0$)	$V_{EB} = 5V$			1	mA
$V_{CEO(sus)}^*$	Collector Emitter Sustaining Voltage	$I_C = 0.2A$ $L = 25mH$	125			V
V_{EBO}	Emitter-base Voltage ($I_C = 0$)	$I_E = 50mA$	7			V
$V_{CE(sat)}^*$	Collector-emitter Saturation Voltage	$I_C = 25A$ $I_B = 1.25A$		0.45	0.9	V
		$I_C = 50A$ $I_B = 5A$		0.65	0.9	V
		$I_C = 60A$ $I_B = 7.5A$		0.75	1.2	V
		$I_C = 25A$ $I_B = 1.25A$ $T_j = 100^{\circ}C$		0.45	1.2	V
		$I_C = 50A$ $I_B = 5A$ $T_j = 100^{\circ}C$		0.7	1.5	V
		$I_C = 60A$ $I_B = 7.5A$ $T_j = 100^{\circ}C$		0.9	1.8	V
$V_{BE(sat)}^*$	Base-emitter Saturation Voltage	$I_C = 50A$ $I_B = 5A$		1.4	1.6	V
		$I_C = 60A$ $I_B = 7.5A$		1.55	1.8	V
		$I_C = 50A$ $I_B = 5A$ $T_j = 100^{\circ}C$		1.45	1.7	V
		$I_C = 60A$ $I_B = 7.5A$ $T_j = 100^{\circ}C$		1.65	1.9	V
di_C/dt	Rated of Rise of On-state Collector Current	$V_{CC} = 100V$ $R_C = 0$ $I_{B1} = 7.5A$ $T_j = 25^{\circ}C$	100 90	160 150		A/ μs A/ μs
		See fig. 2 $T_j = 100^{\circ}C$				
$V_{CE(2\mu s)}$	Collector-emitter Dynamic Voltage	$V_{CC} = 100V$ $R_C = 2\Omega$ See fig. 2 $I_{B1} = 5A$ $T_j = 25^{\circ}C$		2.5 3	3 4.5	V V
		See fig. 2 $T_j = 100^{\circ}C$				
$V_{CE(4\mu s)}$	Collector-emitter Dynamic Voltage	$V_{CC} = 100V$ $R_C = 2\Omega$ See fig. 2 $I_{B1} = 5A$ $T_j = 25^{\circ}C$		1.8 1.9	2.2 3	V V
		See fig. 2 $T_j = 100^{\circ}C$				

RESISTIVE LOAD

Symbol	Parameter	Test Conditions	Min.	Typ.	Max.	Unit
t_r	Rise Time	$V_{CC} = 100V$ $I_C = 60A$		0.5	0.8	μs
t_s	Storage Time	$V_{BB} = -5V$ $I_{B1} = 7.5A$		0.6	1.1	μs
t_f	Fall Time	$R_B = 0.33\Omega$ $t_p = 30\mu s$ See fig. 1		0.06	0.2	μs

ELECTRICAL CHARACTERISTICS (continued)

INDUCTIVE LOAD

Symbol	Parameter	Test Conditions		Min.	Typ.	Max.	Unit
t_s	Storage Time	$V_{CC} = 100V$	$V_{clamp} = 125V$		0.5	1.2	μs
t_f	Fall Time	$I_C = 50A$	$I_B = 5A$		0.05	0.15	μs
t_t	Tail Time in Turn-on	$V_{BB} = -5V$	$R_{B2} = 0.5\Omega$		0.01	0.05	μs
t_c	Crossover Time	$L_C = 0.1mH$	see fig. 3		0.1	0.3	μs
t_s	Storage Time	$V_{CC} = 100V$	$V_{clamp} = 125V$		0.85	1.5	μs
t_f	Fall Time	$I_C = 50A$	$I_B = 5A$		0.12	0.25	μs
t_t	Tail Time in Turn-on	$V_{BB} = -5V$	$R_{B2} = 0.5\Omega$		0.04	0.1	μs
t_c	Crossover Time	$L_C = 0.1mH$	$T_j = 100^\circ C$		0.2	0.5	μs
t_s	Storage Time	$V_{CC} = 100V$	$V_{clamp} = 125V$		1.5		μs
t_f	Fall Time	$I_C = 50A$	$I_B = 5A$		1.3		μs
t_t	Tail Time in Turn-on	$V_{BB} = 0$	$R_{B2} = 1.5\Omega$		0.4		μs
		$L_C = 0.1mH$	see fig. 3				
t_s	Storage Time	$V_{CC} = 100V$	$V_{clamp} = 125V$		2.7		μs
t_f	Fall Time	$I_C = 50A$	$I_B = 5A$		1.8		μs
t_t	Tail Time in Turn-on	$V_{BB} = 0$	$R_{B2} = 1.5\Omega$		0.6		μs
		$L_C = 0.1mH$	$T_j = 100^\circ C$				
		see fig. 3					

* Pulsed : Pulse duration = 300 μs , duty cycle = 2%.

Figure 1 : Switching Times Test Circuit (resistive load).

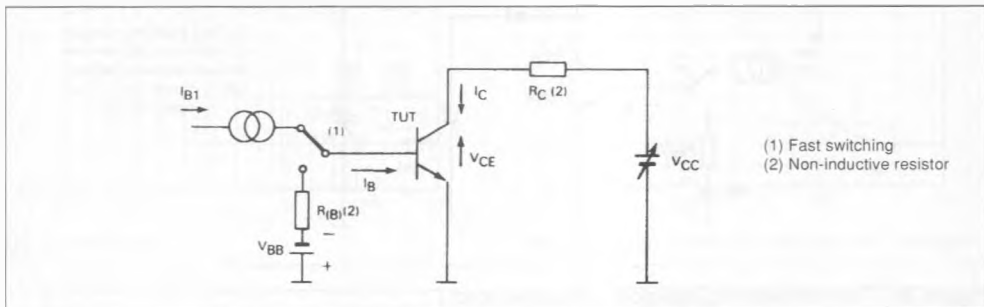

Figure 2 : Turn-on Switching Waveforms.

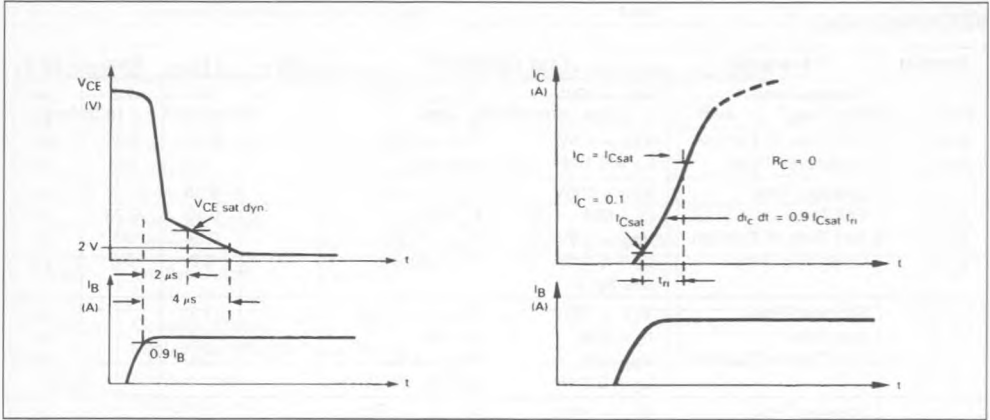

Figure 3a : Turn-off Switching Test Circuit.

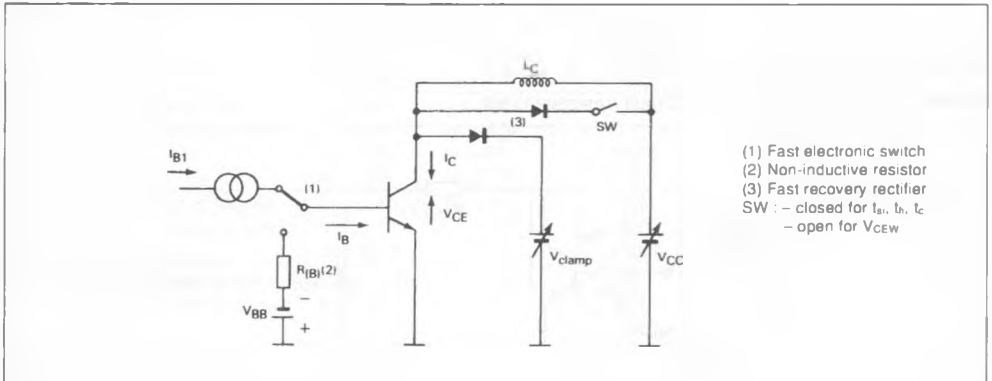
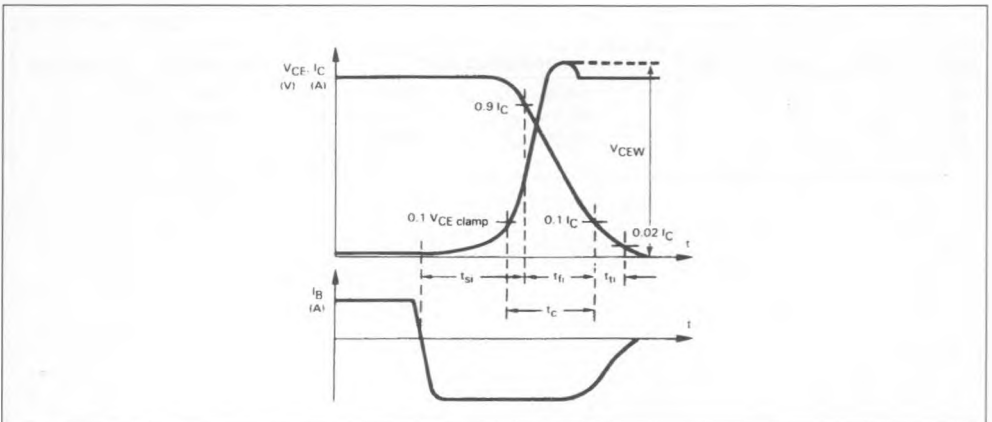
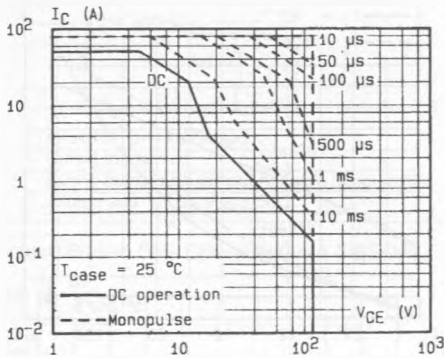

Figure 3b : Turn-off Switching Waveforms (inductive load).



DC and AC Pulse Area.



Power and $I_{S/B}$ Derating versus Case Temperature.

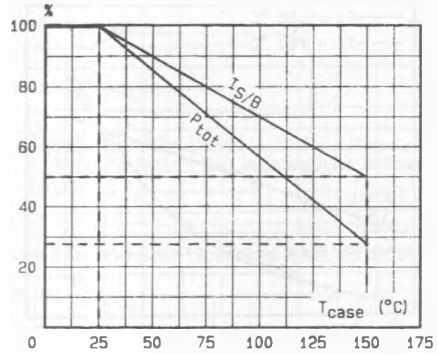

Transient Thermal Response.

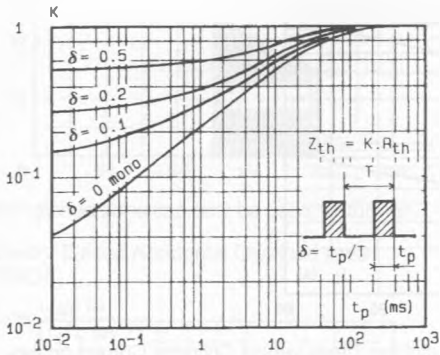

Collector-emitter Voltage versus Base-emitter Resistance.

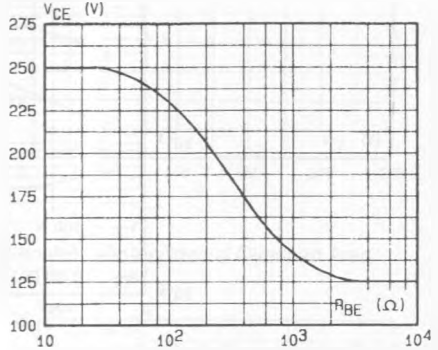

DC Current Gain.

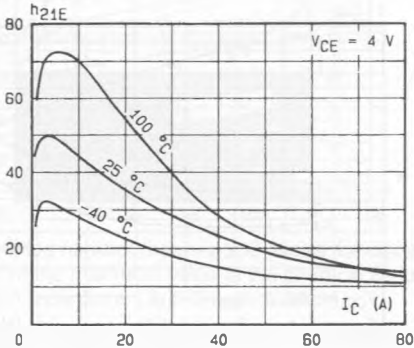

Minimum Base Current to saturate the Transistor.

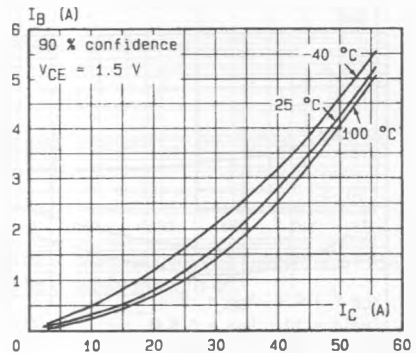

Saturation Voltage.

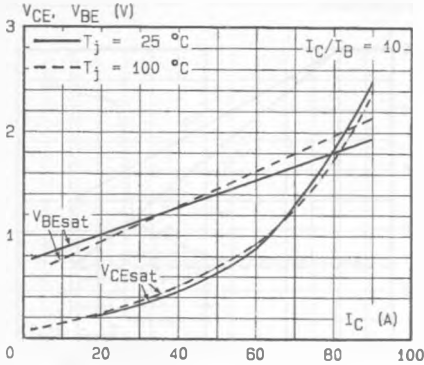

Saturation Voltage.

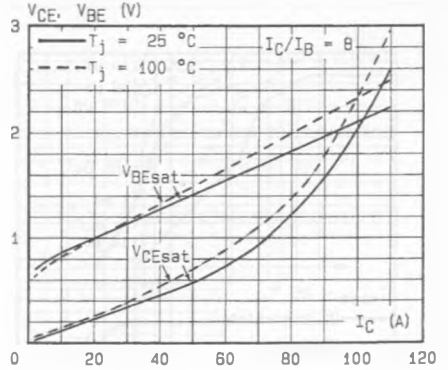

Switching Times versus Collector Current (resistive load).

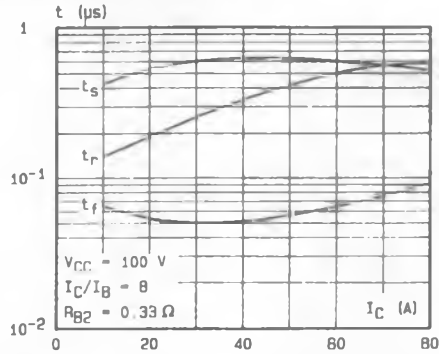

Switching Times versus Collector Current (inductive load).

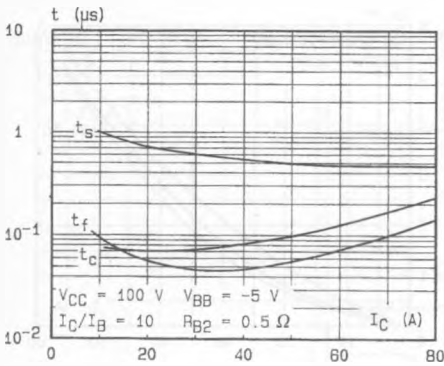

Switching Times versus Collector Current (inductive load).

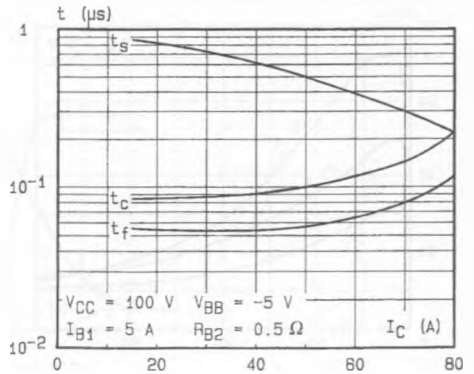

SWITCHING OPERATING AND OVERLOAD AREAS

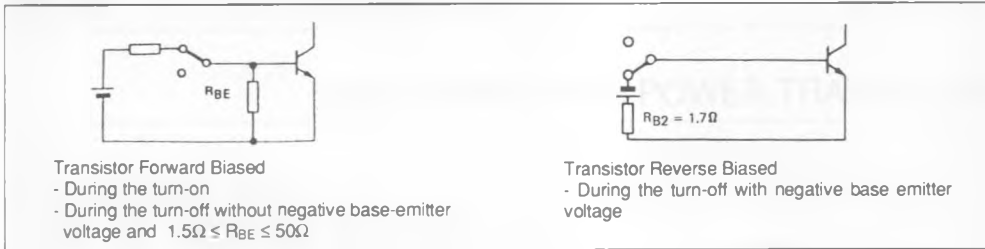

Forward Biased Safe Operating Area (FBSOA).

Reverse Biased Safe Operating Area (RBSOA).

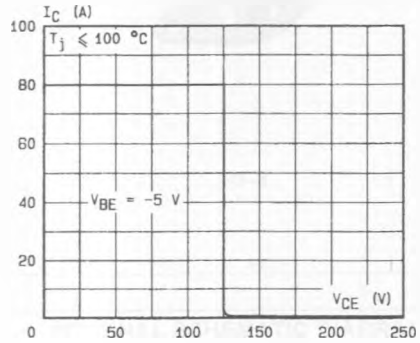
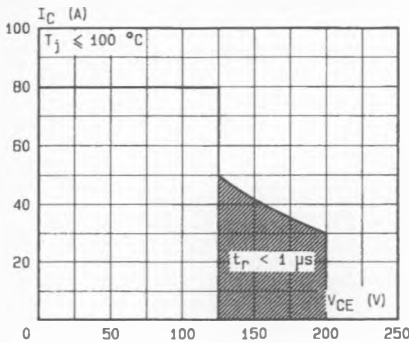

The hatched zone can only be used for turn-on.

Forward Biased Accidental Overload Area (FBAOA).

Reverse Biased Accidental Overload Area (RBAOA).

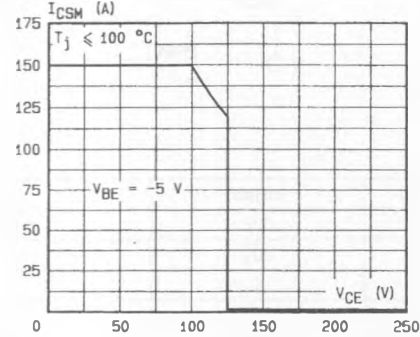
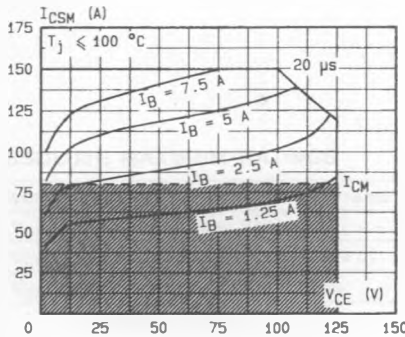

The Kellog network (heavy point) allows the calculation of the maximum value of the short-circuit for a given base current I_B (90% confidence).

After the accidental overload current the RBAOA has to be used for the turn-off.

High accidental surge currents (I_{CM}) are allowed if they are non repetitive and applied less than 3000 times during the component life.