

## FAST SWITCHING POWER TRANSISTOR

- FAST SWITCHING TIMES
- LOW SWITCHING LOSSES
- VERY LOW SATURATION VOLTAGE AND HIGH GAIN FOR REDUCED LOAD OPERATION

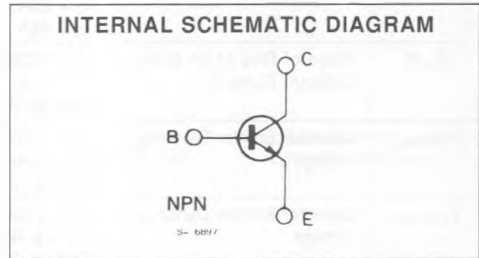
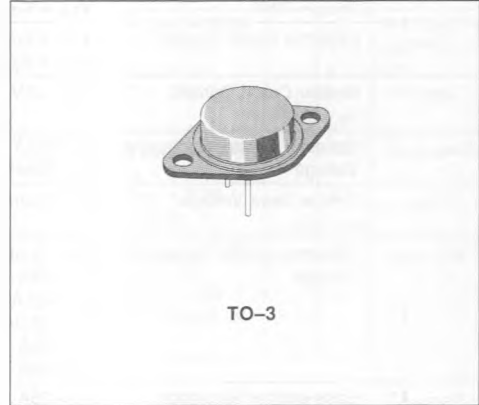

### ABSOLUTE MAXIMUM RATINGS

Symbol	Parameter	Value	Unit
$V_{CEV}$	Collector-emitter Voltage ( $V_{BE} = -1.5V$ )	300	V
$V_{CEO}$	Collector-emitter Voltage ( $I_B = 0$ )	200	V
$V_{EBO}$	Emitter-base Voltage ( $I_C = 0$ )	7	V
$I_C$	Collector Current	50	A
$I_{CM}$	Collector Peak Current	75	A
$I_B$	Base Current	8	A
$I_{BM}$	Base Peak Current	15	A
$P_{base}$	Reverse Bias Base Dissipation (B.E. junction in avalanche)	2	W
$P_{tot}$	Total Dissipation at $T_C < 25^\circ C$	250	W
$T_{stg}$	Storage Temperature	- 65 to 200	$^\circ C$
$T_J$	Max. Operating Junction Temperature	200	$^\circ C$

**THERMAL DATA**

$R_{th(j-case)}$	Thermal Resistance Junction-case	Max	0.7	°C/W
------------------	----------------------------------	-----	-----	------

**ELECTRICAL CHARACTERISTICS** ( $T_{case} = 25^{\circ}C$  unless otherwise specified)

Symbol	Parameter	Test Conditions	Min.	Typ.	Max.	Unit
$I_{CER}$	Collector Cutoff Current ( $R_{BE} = 10\Omega$ )	$V_{CE} = V_{CEV}$ $V_{CE} = V_{CEV}$ $T_C = 100^{\circ}C$			1 5	mA mA
$I_{CEV}$	Collector Cutoff Current	$V_{CE} = V_{CEV}$ $V_{BE} = -1.5V$ $V_{CE} = V_{CEV}$ $V_{BE} = -1.5V$ $T_C = 100^{\circ}C$			1 4	mA mA
$I_{EBO}$	Emitter Cutoff Current ( $I_C = 0$ )	$V_{EB} = 5V$			1	mA
$V_{CEO(sus)}^*$	Collector Emitter Sustaining Voltage	$I_C = 0.2A$ $L = 25mH$	200			V
$V_{EBO}$	Emitter-base Voltage ( $I_C = 0$ )	$I_E = 50mA$	7			V
$V_{CE(sat)}^*$	Collector-emitter Saturation Voltage	$I_C = 12.5A$ $I_B = 0.625A$ $I_C = 25A$ $I_B = 2.5A$ $I_C = 40A$ $I_B = 5A$ $I_C = 12.5A$ $I_B = 0.625A$ $T_j = 100^{\circ}C$ $I_C = 25A$ $I_B = 2.5A$ $T_j = 100^{\circ}C$ $I_C = 40A$ $I_B = 5A$ $T_j = 100^{\circ}C$		0.65 0.4 0.6 0.5 0.5 0.75	0.9 0.9 1.2 1.2 1.5 1.9	V V V V V V
$V_{BE(sat)}^*$	Base-emitter Saturation Voltage	$I_C = 25A$ $I_B = 2.5A$ $I_C = 40A$ $I_B = 5A$ $I_C = 25A$ $I_B = 2.5A$ $T_j = 100^{\circ}C$ $I_C = 40A$ $I_B = 5A$ $T_j = 100^{\circ}C$		1.05 1.35 1.1 1.35	1.4 1.8 1.7 1.8	V V V V
$di_C/dt$	Rated of Rise of on-state Collector Current	$V_{CC} = 160V$ $R_C = 0$ See fig. 2	$I_{B1} = 3.75A$ $T_j = 25^{\circ}C$ $T_j = 100^{\circ}C$	70 60	130 110	A/ $\mu s$ A/ $\mu s$
$V_{CE(2\mu s)}$	Collector Emitter Dynamic Voltage	$V_{CC} = 160V$ $R_C = 6.4\Omega$ See fig. 2	$I_{B1} = 2.5A$ $T_j = 25^{\circ}C$ $T_j = 100^{\circ}C$		1.3 3 1.8 5	V V V V
$V_{CE(4\mu s)}$	Collector Emitter Dynamic Voltage	$V_{CC} = 160V$ $R_C = 6.4\Omega$ See fig. 2	$I_{B1} = 2.5A$ $T_j = 25^{\circ}C$ $T_j = 100^{\circ}C$		0.95 2 1.1 3	V V V V

**RESISTIVE LOAD**

Symbol	Parameter	Test Conditions	Min.	Typ.	Max.	Unit
$t_r$	Rise Time	$V_{CC} = 160V$		0.55	0.7	$\mu s$
$t_s$	Storage Time	$V_{BB} = -5V$		0.6	1.2	$\mu s$
$t_f$	Fall Time	$R_{B2} = 0.5\Omega$ See fig. 1		0.07	0.3	$\mu s$

**ELECTRICAL CHARACTERISTICS** (continued)

INDUCTIVE LOAD

Symbol	Parameter	Test Conditions		Min.	Typ.	Max.	Unit
$t_s$	Storage Time	$V_{CC} = 160V$	$V_{clamp} = 200V$		0.85	1.9	$\mu s$
$t_f$	Fall time	$I_C = 25A$	$I_B = 2.5A$		0.06	0.15	$\mu s$
$t_t$	Tail Time in Turn-on	$V_{BB} = -5V$	$R_{B2} = 1\Omega$		0.01	0.07	$\mu s$
$t_c$	Crossover Time	$L_C = 0.32mH$	See fig. 3		0.11	0.3	$\mu s$
$t_s$	Storage Time	$V_{CC} = 160V$	$V_{clamp} = 200V$		1.1	2.4	$\mu s$
$t_f$	Fall time	$I_C = 25A$	$I_B = 2.5A$		0.08	0.25	$\mu s$
$t_t$	Tail Time in Turn-on	$V_{BB} = -5V$	$R_{B2} = 1\Omega$		0.02	0.15	$\mu s$
$t_c$	Crossover Time	$L_C = 0.32mH$	$T_J = 100^\circ C$		0.15	0.5	$\mu s$
$t_s$	Storage Time	$V_{CC} = 160V$	$V_{clamp} = 200V$		1.6		$\mu s$
$t_f$	Fall time	$I_C = 25A$	$I_B = 2.5A$		0.7		$\mu s$
$t_t$	Tail Time in Turn-on	$V_{BB} = 0$	$R_{B2} = 2.7\Omega$		0.2		$\mu s$
		$L_C = 0.32mH$	See fig. 3				
$t_s$	Storage Time	$V_{CC} = 160V$	$V_{clamp} = 200V$		2.7		$\mu s$
$t_f$	Fall time	$I_C = 25A$	$I_B = 2.5A$		1		$\mu s$
$t_t$	Tail Time in Turn-on	$V_{BB} = 0$	$R_{B2} = 2.7\Omega$		0.3		$\mu s$
		$L_C = 0.32mH$	$T_J = 100^\circ C$				
		See fig. 3					

\* Pulsed : Pulse duration = 300 $\mu s$ , duty cycle = 2%.

**Figure 1 : Switching Times Test Circuit (resistive load).**

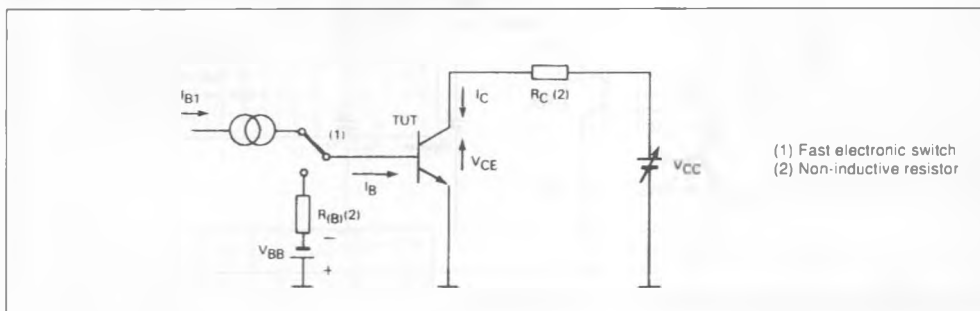

Figure 2 : Turn-on Switching Waveforms.

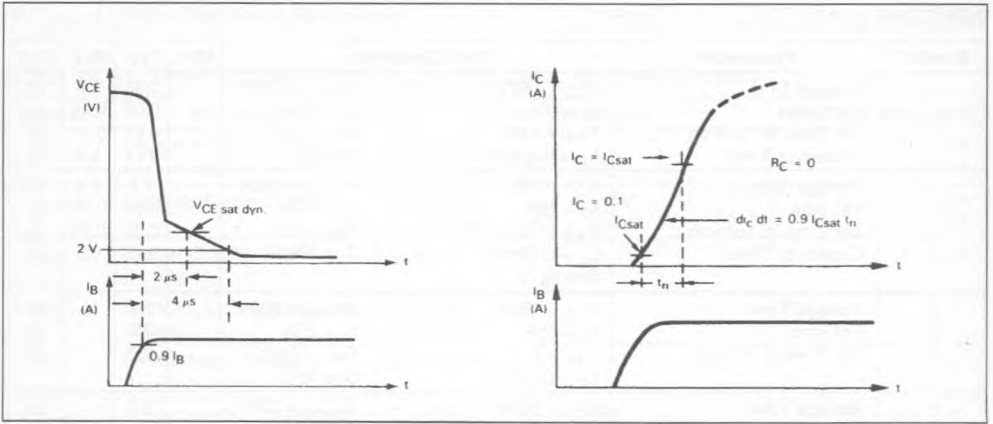

Figure 3a : Turn-off Switching Test Circuits.

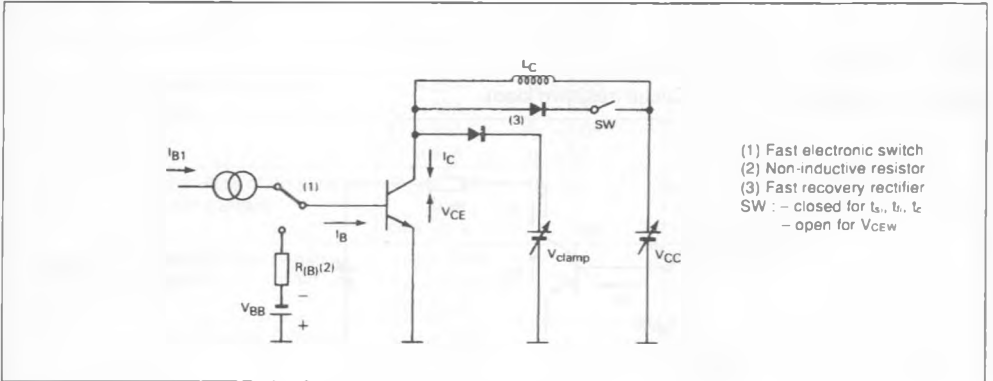
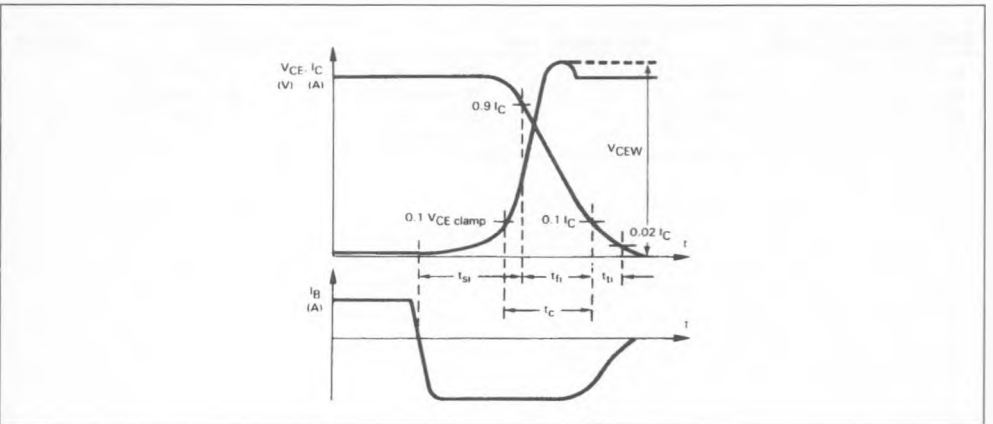
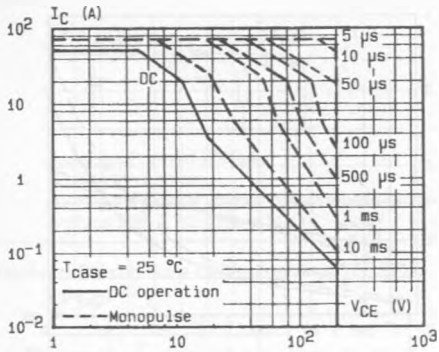

Figure 3b : Turn-off Switching Waveforms (inductive load).



DC and AC Pulse Area.



Power and  $I_{S/B}$  Derating versus Case Temperature.

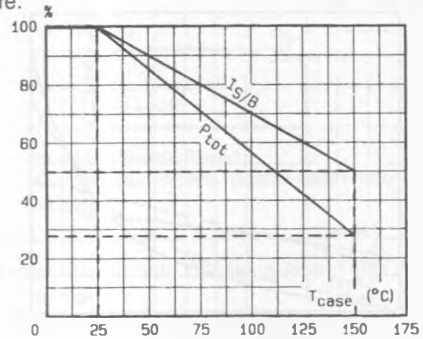

Transient Thermal Response.

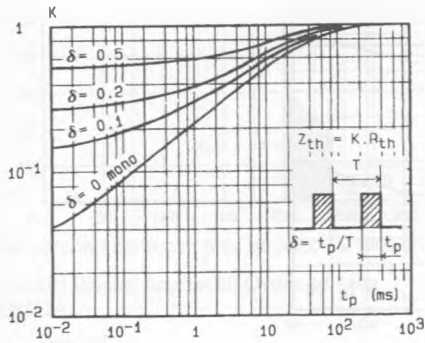

Collector-emitter Voltage versus Base-emitter Resistance.

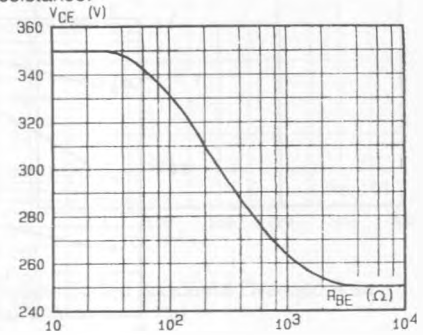

DC Current Gain.

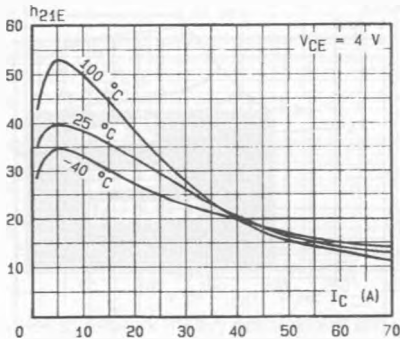

Minimum Base Current to saturate the Transistor.

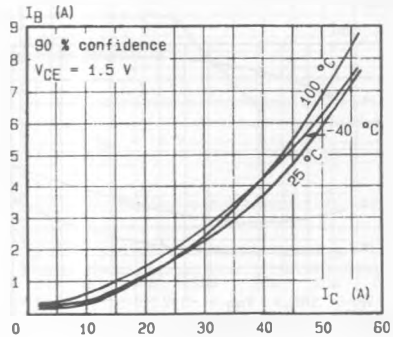

Saturation Voltage.

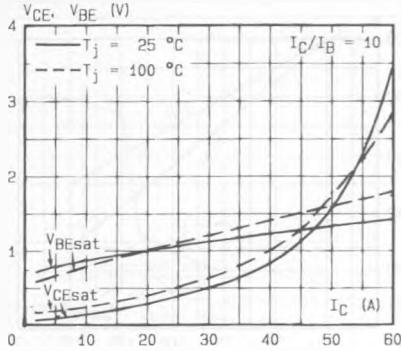

Saturation Voltage.

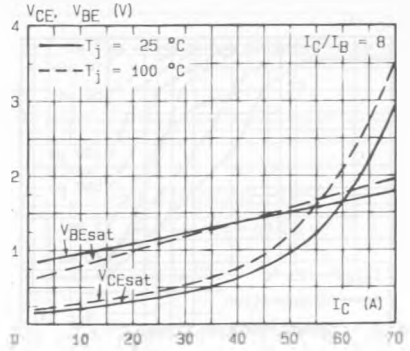

Switching Times versus Collector Current (resistive load).

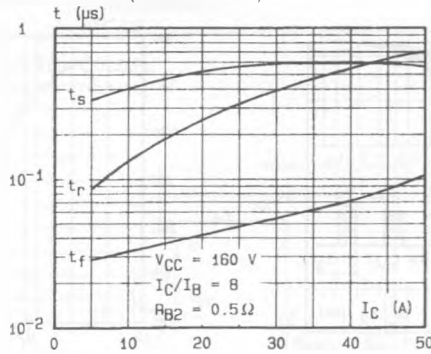

Switching Times versus Collector Current (inductive load).

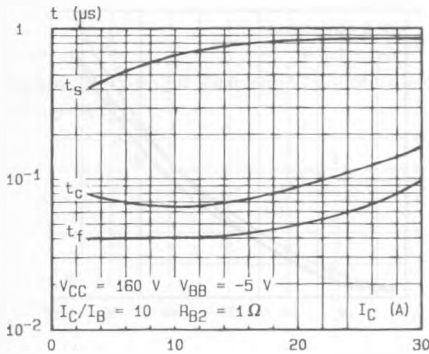

Switching Times versus Collector Current (inductive load).

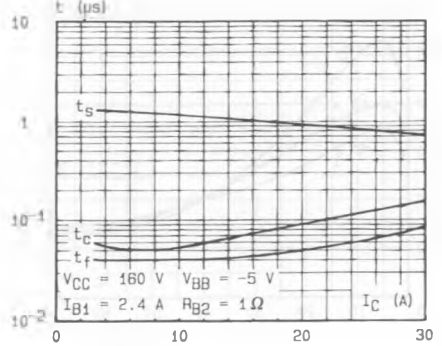

SWITCHING OPERATING AND OVERLOAD AREAS

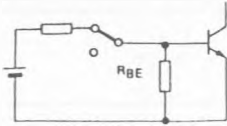

Transistor Forward Biased

- During the turn-on
- During the turn-off without negative base-emitter voltage and  $2.7\Omega \leq R_{BE} \leq 50\Omega$

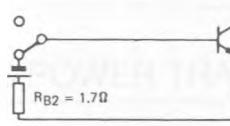

Transistor Reverse Biased

- During the turn-off with negative base emitter voltage

Forward Biased Safe Operating Area (FBSOA).

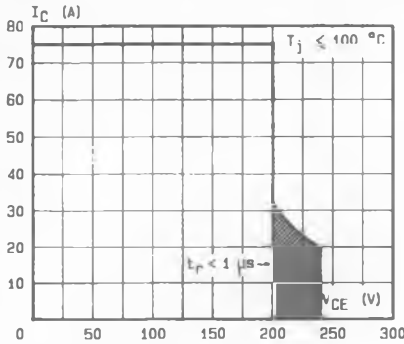

The hatched zone can only be used for turn-on.

Forward Biased Accidental Overload Area (FBAOA).

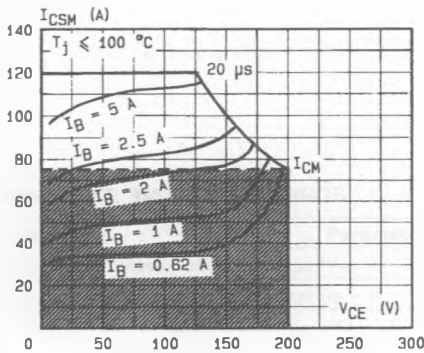

The Kellog network (heavy point) allows the calculation of the maximum value of the short-circuit for a given base current  $I_B$  (90 % confidence).

High accidental surge currents ( $I > I_{CM}$ ) are allowed if they are non repetitive and applied less than 3000 times during the component life.

Reverse Biased Safe Operating Area (RBSOA).

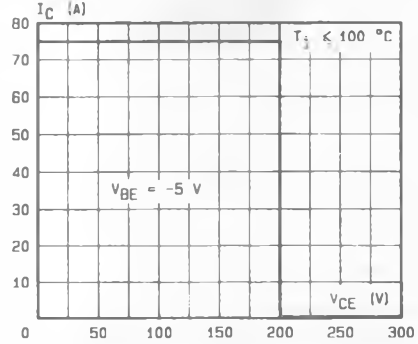

Reverse Biased Accidental Overload Area (RBAOA).

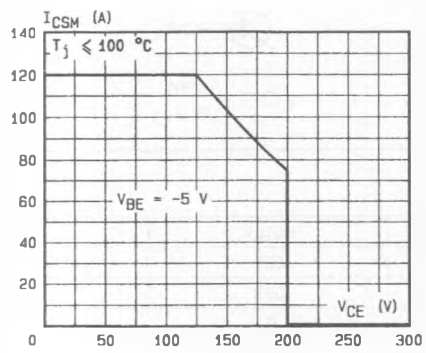

After the accidental overload current the RBAOA has to be used for the turn-off.