

N-Channel NexFET™ Power MOSFET

FEATURES

- **Ultralow Q_g and Q_{gd}**
- **Low Thermal Resistance**
- **Avalanche Rated**
- **SON 5-mm × 6-mm Plastic Package**

APPLICATIONS

- **Point-of-Load Synchronous Buck in Networking, Telecom and Computing Systems**
- **Optimized for Control FET Applications**

DESCRIPTION

The NexFET™ power MOSFET has been designed to minimize losses in power conversion applications.

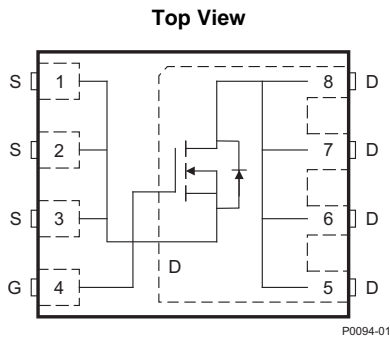

PRODUCT SUMMARY

V_{DS}	Drain-to-source voltage	25	V
Q_g	Gate charge, total (4.5 V)	6.7	nC
Q_{gd}	Gate charge, gate-to-drain	1.9	nC
$r_{DS(on)}$	Drain-to-source on-resistance	$V_{GS} = 4.5\text{ V}$	5.4 mΩ
		$V_{GS} = 10\text{ V}$	3.6 mΩ
$V_{GS(th)}$	Threshold voltage	1.8	V

ORDERING INFORMATION

Device	Package	Media	Qty	Ship
CSD16408Q5	SON 5-mm × 6-mm plastic package	13-inch (33-cm) reel	2500	Tape and reel

ABSOLUTE MAXIMUM RATINGS

$T_A = 25^\circ\text{C}$ unless otherwise stated		VALUE	UNIT
V_{DS}	Drain-to-source voltage	25	V
V_{GS}	Gate-to-source voltage	-12 to 16	V
I_D	Continuous drain current, $T_C = 25^\circ\text{C}$	113	A
	Continuous drain current ⁽¹⁾	22	A
I_{DM}	Pulsed drain current, $T_A = 25^\circ\text{C}$ ⁽²⁾	141	A
P_D	Power dissipation ⁽¹⁾	3.1	W
T_J, T_{STG}	Operating junction and storage temperature range	-55 to 150	$^\circ\text{C}$
E_{AS}	Avalanche energy, single-pulse $I_D = 23\text{ A}, L = 0.1\text{ mH}, R_G = 25\ \Omega$	126	mJ

- (1) Typical $R_{\theta JA} = 41^\circ\text{C/W}$ on 1-inch² (6.45-cm²), 2-oz. (0.071-mm thick) Cu pad on a 0.06-inch (1.52-mm) thick FR4 PCB.
- (2) Pulse duration $\leq 300\ \mu\text{s}$, duty cycle $\leq 2\%$

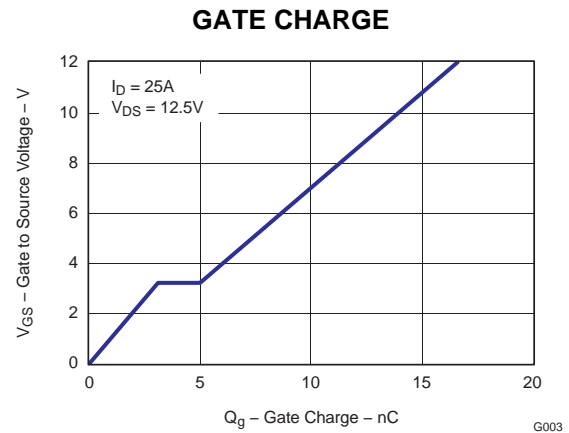
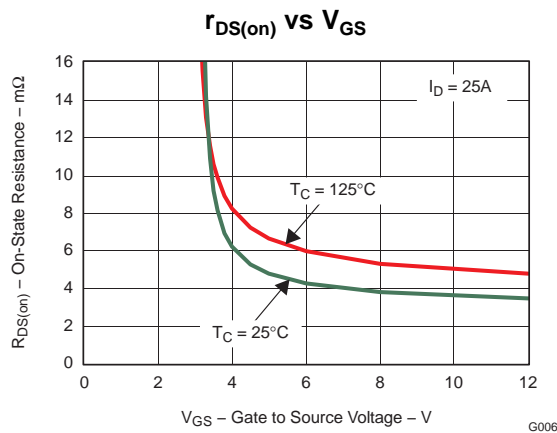

Please be aware that an important notice concerning availability, standard warranty, and use in critical applications of Texas Instruments semiconductor products and disclaimers thereto appears at the end of this data sheet.

NexFET is a trademark of Texas Instruments.

ELECTRICAL CHARACTERISTICS

T_A = 25°C unless otherwise stated

PARAMETER		TEST CONDITIONS	MIN	TYP	MAX	UNIT
Static Characteristics						
B _V DSS	Drain-to-source voltage	V _{GS} = 0 V, I _D = 250 μA	25			V
I _{DSS}	Drain-to-source leakage	V _{GS} = 0 V, V _{DS} = 20 V			1	μA
I _{GSS}	Gate-to-source leakage	V _{DS} = 0 V, V _{GS} = -12 V to 16 V			100	nA
V _{GS(th)}	Gate-to-source threshold voltage	V _{DS} = V _{GS} , I _D = 250 μA	1.4	1.8	2.1	V
r _{DS(on)}	Drain-to-source on-resistance	V _{GS} = 4.5 V, I _D = 25 A		5.4	6.8	mΩ
		V _{GS} = 10 V, I _D = 25 A		3.6	4.5	mΩ
g _{fs}	Transconductance	V _{DS} = 15 V, I _D = 25 A		60		S
Dynamic Characteristics						
C _{ISS}	Input capacitance	V _{GS} = 0 V, V _{DS} = 12.5 V, f = 1 MHz		990	1300	pF
C _{OSS}	Output capacitance			760	1000	pF
C _{RSS}	Reverse transfer capacitance			75	100	pF
R _g	Series gate resistance	V _{DS} = 12.5 V, I _D = 25 A		0.8	1.6	Ω
Q _g	Gate charge total (4.5 V)			6.7	8.9	nC
Q _{gd}	Gate charge, gate-to-drain			1.9		nC
Q _{gs}	Gate charge, gate-to-source			3.1		nC
Q _{g(th)}	Gate charge at V _{th}			1.8		nC
Q _{OSS}	Output charge	V _{DS} = 13 V, V _{GS} = 0 V		15.7		nC
t _{d(on)}	Turnon delay time	V _{DS} = 12.5 V, V _{GS} = 4.5 V, I _D = 20 A, R _G = 2 Ω		11.3		ns
t _r	Rise time			25		ns
t _{d(off)}	Turnoff delay time			11		ns
t _f	Fall time			10.8		ns
Diode Characteristics						
V _{SD}	Diode forward voltage	I _S = 25 A, V _{GS} = 0 V		0.8	1	V
Q _{rr}	Reverse recovery charge	V _{DD} = 13 V, I _F = 2.5 A, di/dt = 300 A/μs		17		nC
t _{rr}	Reverse recovery time	V _{DD} = 13 V, I _F = 25 A, di/dt = 300 A/μs		21		ns

THERMAL CHARACTERISTICS

T_A = 25°C unless otherwise stated

PARAMETER		MIN	TYP	MAX	UNIT
R _{θJC}	Thermal Resistance Junction to Case ⁽¹⁾			1.9	°C/W
R _{θJA}	Thermal Resistance Junction to Ambient ^{(1) (2)}			51	°C/W

- (1) R_{θJC} is determined with the device mounted on a 1-inch² (6.45-cm²), 2-oz. (0.071-mm thick) Cu pad on a 1.5-inch × 1.5-inch (3.81-cm × 3.81-cm), 0.06-inch (1.52-mm) thick FR4 PCB. R_{θJC} is specified by design, whereas R_{θJA} is determined by the user's board design.
- (2) Device mounted on FR4 material with 1-inch² (6.45-cm²), 2-oz. (0.071-mm thick) Cu.



M0137-01

Max $R_{\theta JA} = 51^{\circ}\text{C/W}$
when mounted on
1 inch² (6.45 cm²) of
2-oz. (0.071-mm thick)
Cu.

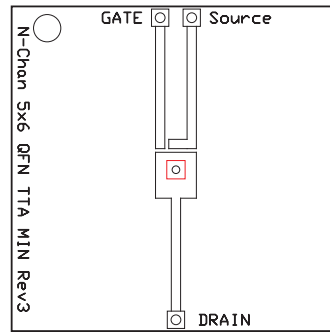

M0137-02

Max $R_{\theta JA} = 125^{\circ}\text{C/W}$
when mounted on
minimum pad area of
2-oz. (0.071-mm thick)
Cu.

TYPICAL MOSFET CHARACTERISTICS

$T_A = 25^{\circ}\text{C}$ unless otherwise stated

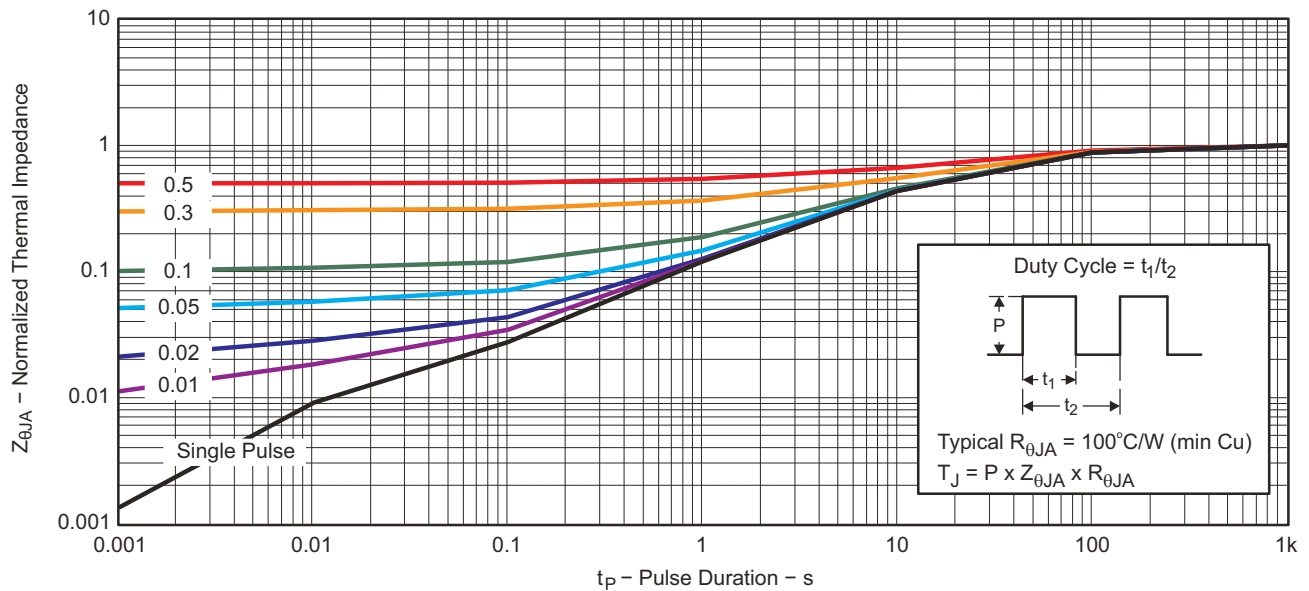

G012

Figure 1. Transient Thermal Impedance

TYPICAL MOSFET CHARACTERISTICS (continued)

T_A = 25°C unless otherwise stated

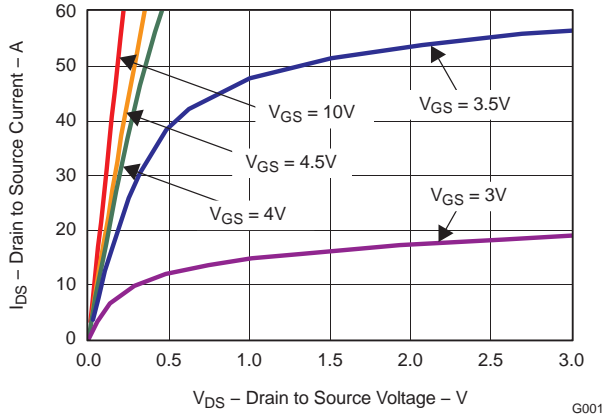

Figure 2. Saturation Characteristics

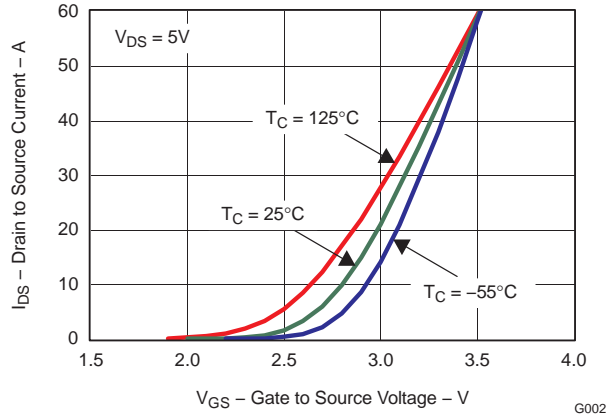

Figure 3. Transfer Characteristics

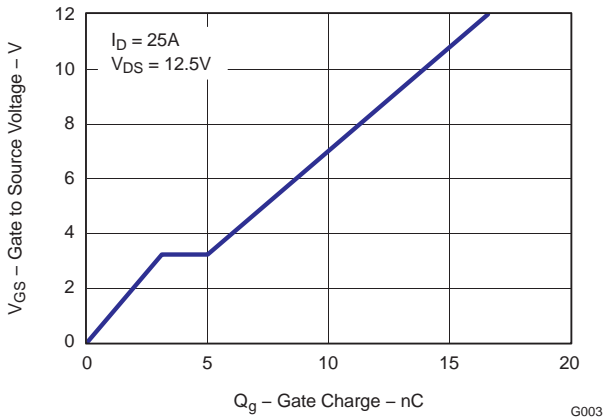

Figure 4. Gate Charge

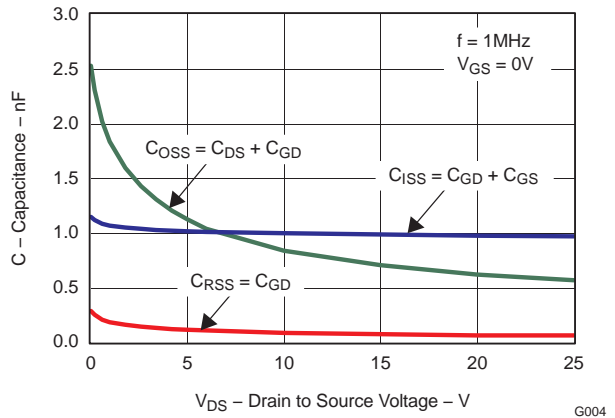

Figure 5. Capacitance

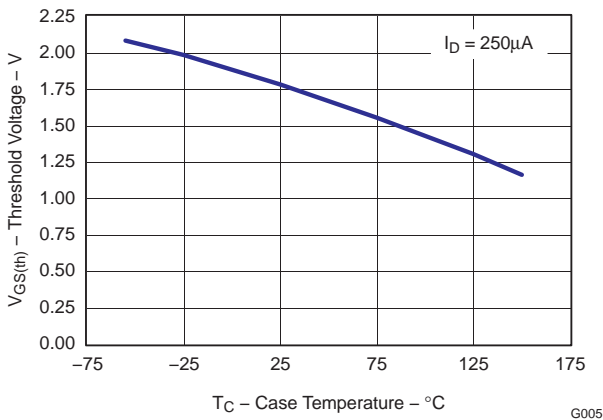

Figure 6. Threshold Voltage vs. Temperature

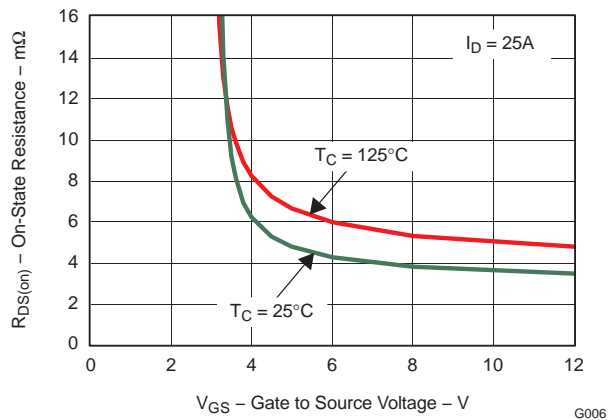

Figure 7. On-State Resistance vs. Gate-to-Source Voltage

TYPICAL MOSFET CHARACTERISTICS (continued)

T_A = 25°C unless otherwise stated

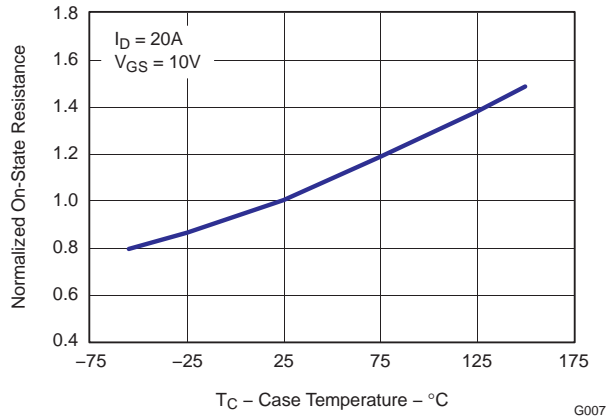

Figure 8. Normalized On-State Resistance vs. Temperature

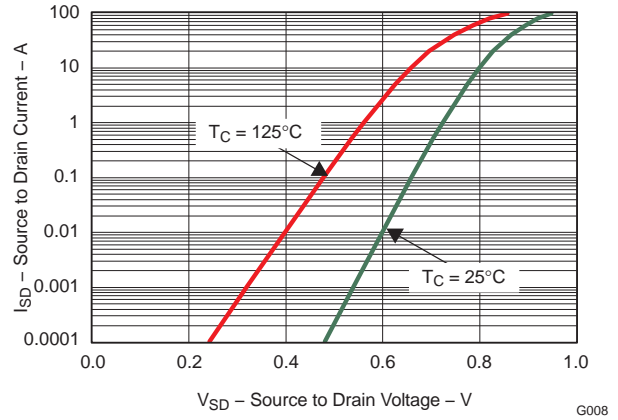

Figure 9. Typical Diode Forward Voltage

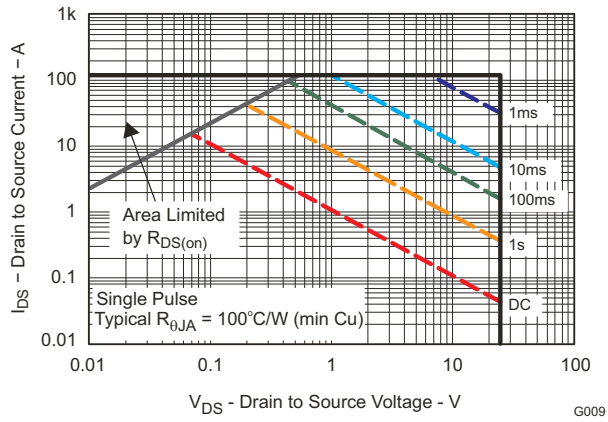

Figure 10. Maximum Safe Operating Area

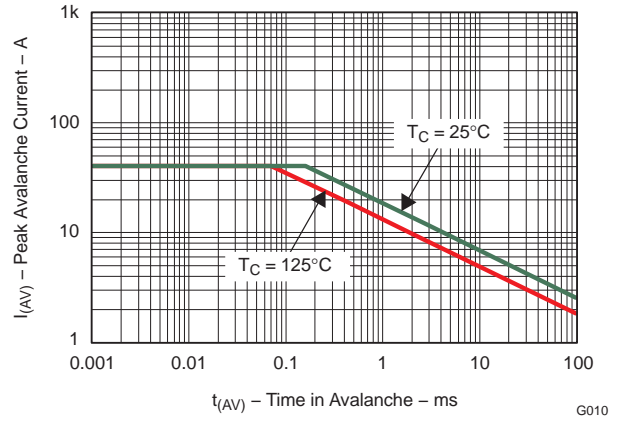

Figure 11. Single-Pulse Unclamped Inductive Switching

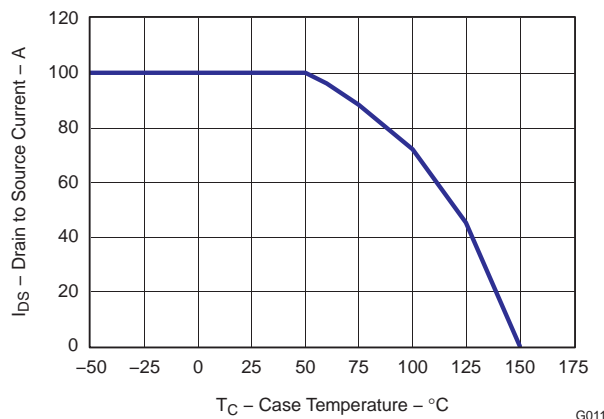

Figure 12. Maximum Drain Current vs. Temperature

MECHANICAL DATA

Q5 Package Dimensions



M0140-01

DIM	MILLIMETERS		INCHES	
	MIN	MAX	MIN	MAX
A	0.950	1.050	0.037	0.039
b	0.360	0.460	0.014	0.018
c	0.150	0.250	0.006	0.010
c1	0.150	0.250	0.006	0.010
D1	4.900	5.100	0.193	0.201
D2	4.320	4.520	0.170	0.178
E	4.900	5.100	0.193	0.201
E1	5.900	6.100	0.232	0.240
E2	3.920	4.12	0.154	0.162
e	1.27 typ		0.050	
L	0.510	0.710	0.020	0.028
θ	0.00	-	-	-

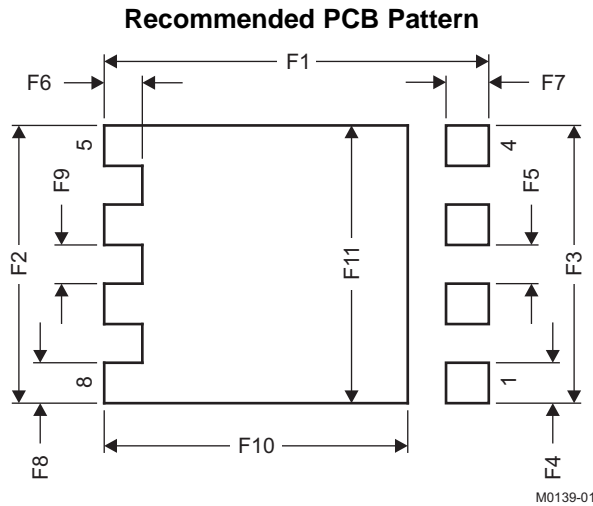

DIM	MILLIMETERS		INCHES	
	MIN	MAX	MIN	MAX
F1	6.205	6.305	0.244	0.248
F2	4.46	4.56	0.176	0.18
F3	4.46	4.56	0.176	0.18
F4	0.65	0.7	0.026	0.028
F5	0.62	0.67	0.024	0.026
F6	0.63	0.68	0.025	0.027
F7	0.7	0.8	0.028	0.031
F8	0.65	0.7	0.026	0.028
F9	0.62	0.67	0.024	0.026
F10	4.9	5	0.193	0.197
F11	4.46	4.56	0.176	0.18

For recommended circuit layout for PCB designs, see application note *Reducing Ringing Through PCB Layout Techniques* (SLPA005).

Q5 Tape and Reel Information

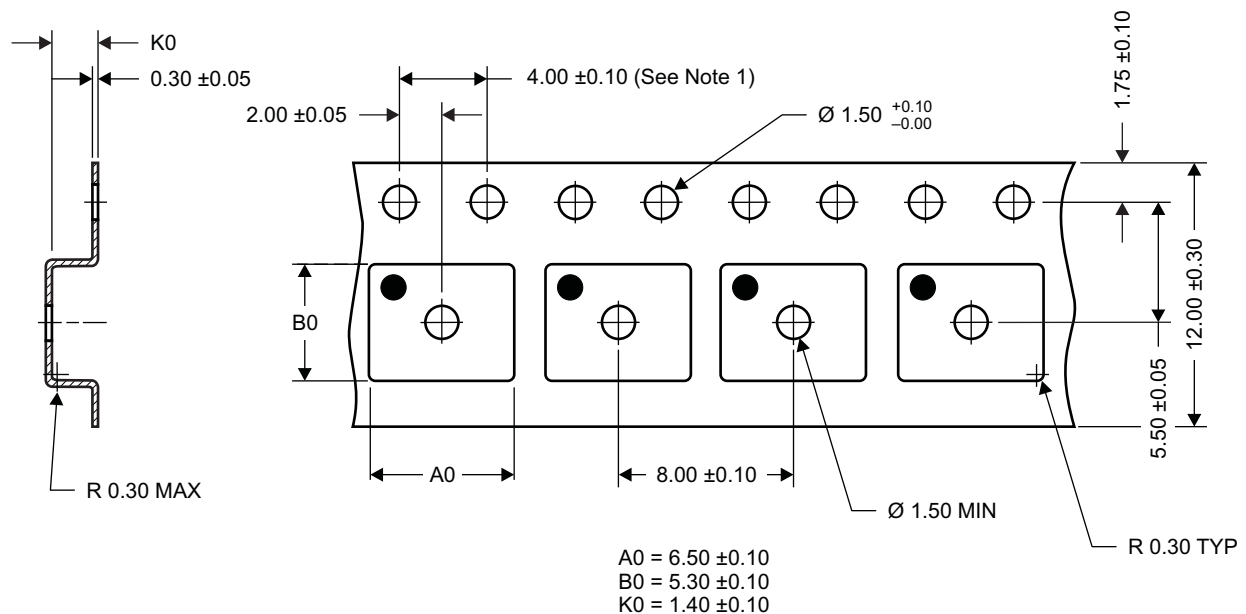

Notes:

- 10-sprocket hole-pitch cumulative tolerance ±0.2
- Camber not to exceed 1 mm in 100 mm, noncumulative over 250 mm
- Material: black static-dissipative polystyrene
- All dimensions are in mm, unless otherwise specified.
- A0 and B0 measured on a plane 0.3 mm above the bottom of the pocket
- MSL1 260°C (IR and convection) PbF reflow compatible

REVISION HISTORY

Changes from Revision Original (October 2009) to Revision A	Page
• Deleted environmental bullets from features list	1
• Deleted package marking section from end of data sheet	7

TAPE AND REEL INFORMATION

QUADRANT ASSIGNMENTS FOR PIN 1 ORIENTATION IN TAPE

*All dimensions are nominal

Device	Package Type	Package Drawing	Pins	SPQ	Reel Diameter (mm)	Reel Width W1 (mm)	A0 (mm)	B0 (mm)	K0 (mm)	P1 (mm)	W (mm)	Pin1 Quadrant
CSD16408Q5	SON	DQH	8	2500	330.0	12.8	6.5	5.3	1.4	8.0	12.0	Q1

TAPE AND REEL BOX DIMENSIONS



*All dimensions are nominal

Device	Package Type	Package Drawing	Pins	SPQ	Length (mm)	Width (mm)	Height (mm)
CSD16408Q5	SON	DQH	8	2500	335.0	335.0	32.0

IMPORTANT NOTICE

Texas Instruments Incorporated and its subsidiaries (TI) reserve the right to make corrections, modifications, enhancements, improvements, and other changes to its products and services at any time and to discontinue any product or service without notice. Customers should obtain the latest relevant information before placing orders and should verify that such information is current and complete. All products are sold subject to TI's terms and conditions of sale supplied at the time of order acknowledgment.

TI warrants performance of its hardware products to the specifications applicable at the time of sale in accordance with TI's standard warranty. Testing and other quality control techniques are used to the extent TI deems necessary to support this warranty. Except where mandated by government requirements, testing of all parameters of each product is not necessarily performed.

TI assumes no liability for applications assistance or customer product design. Customers are responsible for their products and applications using TI components. To minimize the risks associated with customer products and applications, customers should provide adequate design and operating safeguards.

TI does not warrant or represent that any license, either express or implied, is granted under any TI patent right, copyright, mask work right, or other TI intellectual property right relating to any combination, machine, or process in which TI products or services are used. Information published by TI regarding third-party products or services does not constitute a license from TI to use such products or services or a warranty or endorsement thereof. Use of such information may require a license from a third party under the patents or other intellectual property of the third party, or a license from TI under the patents or other intellectual property of TI.

Reproduction of TI information in TI data books or data sheets is permissible only if reproduction is without alteration and is accompanied by all associated warranties, conditions, limitations, and notices. Reproduction of this information with alteration is an unfair and deceptive business practice. TI is not responsible or liable for such altered documentation. Information of third parties may be subject to additional restrictions.

Resale of TI products or services with statements different from or beyond the parameters stated by TI for that product or service voids all express and any implied warranties for the associated TI product or service and is an unfair and deceptive business practice. TI is not responsible or liable for any such statements.

TI products are not authorized for use in safety-critical applications (such as life support) where a failure of the TI product would reasonably be expected to cause severe personal injury or death, unless officers of the parties have executed an agreement specifically governing such use. Buyers represent that they have all necessary expertise in the safety and regulatory ramifications of their applications, and acknowledge and agree that they are solely responsible for all legal, regulatory and safety-related requirements concerning their products and any use of TI products in such safety-critical applications, notwithstanding any applications-related information or support that may be provided by TI. Further, Buyers must fully indemnify TI and its representatives against any damages arising out of the use of TI products in such safety-critical applications.

TI products are neither designed nor intended for use in military/aerospace applications or environments unless the TI products are specifically designated by TI as military-grade or "enhanced plastic." Only products designated by TI as military-grade meet military specifications. Buyers acknowledge and agree that any such use of TI products which TI has not designated as military-grade is solely at the Buyer's risk, and that they are solely responsible for compliance with all legal and regulatory requirements in connection with such use.

TI products are neither designed nor intended for use in automotive applications or environments unless the specific TI products are designated by TI as compliant with ISO/TS 16949 requirements. Buyers acknowledge and agree that, if they use any non-designated products in automotive applications, TI will not be responsible for any failure to meet such requirements.

Following are URLs where you can obtain information on other Texas Instruments products and application solutions:

Products

Audio	www.ti.com/audio
Amplifiers	amplifier.ti.com
Data Converters	dataconverter.ti.com
DLP® Products	www.dlp.com
DSP	dsp.ti.com
Clocks and Timers	www.ti.com/clocks
Interface	interface.ti.com
Logic	logic.ti.com
Power Mgmt	power.ti.com
Microcontrollers	microcontroller.ti.com
RFID	www.ti-rfid.com
RF/IF and ZigBee® Solutions	www.ti.com/lprf

Applications

Communications and Telecom	www.ti.com/communications
Computers and Peripherals	www.ti.com/computers
Consumer Electronics	www.ti.com/consumer-apps
Energy and Lighting	www.ti.com/energy
Industrial	www.ti.com/industrial
Medical	www.ti.com/medical
Security	www.ti.com/security
Space, Avionics and Defense	www.ti.com/space-avionics-defense
Transportation and Automotive	www.ti.com/automotive
Video and Imaging	www.ti.com/video
Wireless	www.ti.com/wireless-apps

TI E2E Community Home Page

e2e.ti.com

Mailing Address: Texas Instruments, Post Office Box 655303, Dallas, Texas 75265
Copyright © 2011, Texas Instruments Incorporated