

# 30V N-Channel NexFET™ Power MOSFET

 Check for Samples: [CSD17303Q5](#)

## FEATURES

- Optimized for 5V Gate Drive
- Ultralow  $Q_g$  and  $Q_{gd}$
- Low Thermal Resistance
- Avalanche Rated
- Pb Free Terminal Plating
- RoHS Compliant
- Halogen Free
- SON 5-mm x 6-mm Plastic Package

## APPLICATIONS

- Notebook Point-of-Load
- Point-of-Load Synchronous Buck in Networking, Telecom and Computing Systems
- Optimized for Synchronous FET Applications

## DESCRIPTION

The NexFET™ power MOSFET has been designed to minimize losses in power conversion applications, and optimized for 5V gate drive applications.

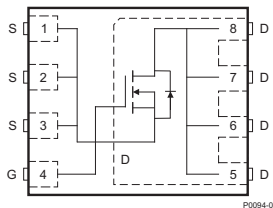
**Top View**

## PRODUCT SUMMARY

$V_{DS}$	Drain to Source Voltage	30	V
$Q_g$	Gate Charge Total (4.5V)	18	nC
$Q_{gd}$	Gate Charge Gate to Drain	4	nC
$R_{DS(on)}$	Drain to Source On Resistance	$V_{GS} = 3V$	2.7 mΩ
		$V_{GS} = 4.5V$	2 mΩ
		$V_{GS} = 8V$	1.7 mΩ
$V_{GS(th)}$	Threshold Voltage	1.1	V

## ORDERING INFORMATION

Device	Package	Media	Qty	Ship
CSD17303Q5	SON 5-mm x 6-mm Plastic Package	13-Inch Reel	2500	Tape and Reel

## ABSOLUTE MAXIMUM RATINGS

$T_A = 25^\circ\text{C}$ unless otherwise stated		VALUE	UNIT
$V_{DS}$	Drain to Source Voltage	30	V
$V_{GS}$	Gate to Source Voltage	+10 / -8	V
$I_D$	Continuous Drain Current, $T_C = 25^\circ\text{C}$	100	A
	Continuous Drain Current <sup>(1)</sup>	32	A
$I_{DM}$	Pulsed Drain Current, $T_A = 25^\circ\text{C}$ <sup>(2)</sup>	200	A
$P_D$	Power Dissipation <sup>(1)</sup>	3.2	W
$T_J$ , $T_{STG}$	Operating Junction and Storage Temperature Range	-55 to 150	$^\circ\text{C}$
$E_{AS}$	Avalanche Energy, single pulse $I_D = 103\text{A}$ , $L = 0.1\text{mH}$ , $R_G = 25\Omega$	530	mJ

- (1)  $R_{\theta JA} = 39^\circ\text{C/W}$  on 1-inch<sup>2</sup> (6.45-cm<sup>2</sup>), 2-oz. (0.071-mm thick) Cu pad on a 0.06-inch (1.52-mm) thick FR4 PCB.  
 (2) Pulse duration  $\leq 300\mu\text{s}$ , duty cycle  $\leq 2\%$

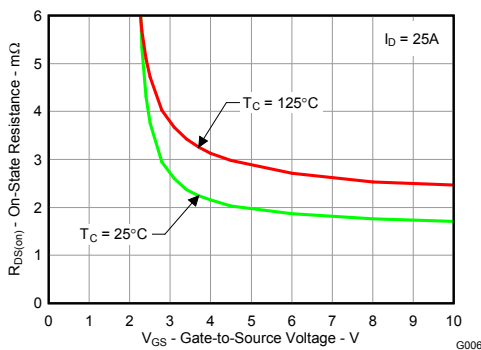
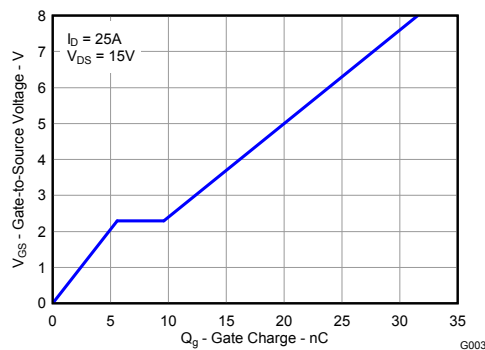
 **$R_{DS(on)}$  vs  $V_{GS}$** 

**GATE CHARGE**

Please be aware that an important notice concerning availability, standard warranty, and use in critical applications of Texas Instruments semiconductor products and disclaimers thereto appears at the end of this data sheet.

NexFET is a trademark of Texas Instruments.

PRODUCTION DATA information is current as of publication date. Products conform to specifications per the terms of the Texas Instruments standard warranty. Production processing does not necessarily include testing of all parameters.



These devices have limited built-in ESD protection. The leads should be shorted together or the device placed in conductive foam during storage or handling to prevent electrostatic damage to the MOS gates.

## ELECTRICAL CHARACTERISTICS

( $T_A = 25^\circ\text{C}$  unless otherwise stated)

PARAMETER		TEST CONDITIONS	MIN	TYP	MAX	UNIT
<b>Static Characteristics</b>						
$BV_{DSS}$	Drain to Source Voltage	$V_{GS} = 0V, I_D = 250\mu A$	30			V
$I_{DSS}$	Drain to Source Leakage Current	$V_{GS} = 0V, V_{DS} = 24V$			1	$\mu A$
$I_{GSS}$	Gate to Source Leakage Current	$V_{DS} = 0V, V_{GS} = +10/-8V$			100	nA
$V_{GS(th)}$	Gate to Source Threshold Voltage	$V_{DS} = V_{GS}, I_D = 250\mu A$	0.9	1.1	1.6	V
$R_{DS(on)}$	Drain to Source On Resistance	$V_{GS} = 3V, I_D = 25A$		2.7	3.7	m $\Omega$
		$V_{GS} = 4.5V, I_D = 25A$		2	2.6	m $\Omega$
		$V_{GS} = 8V, I_D = 25A$		1.7	2.4	m $\Omega$
$g_{fs}$	Transconductance	$V_{DS} = 15V, I_D = 25A$		114		S
<b>Dynamic Characteristics</b>						
$C_{iss}$	Input Capacitance	$V_{GS} = 0V, V_{DS} = 15V,$ $f = 1\text{MHz}$		2630	3420	pF
$C_{oss}$	Output Capacitance			1440	1870	pF
$C_{riss}$	Reverse Transfer Capacitance			83	108	pF
$R_G$	Series Gate Resistance			1.4	2.8	$\Omega$
$Q_g$	Gate Charge Total (4.5V)	$V_{DS} = 15V,$ $I_{DS} = 25A$		18	23	nC
$Q_{gd}$	Gate Charge Gate to Drain			4		nC
$Q_{gs}$	Gate Charge Gate to Source			5.6		nC
$Q_{g(th)}$	Gate Charge at $V_{th}$			3		nC
$Q_{oss}$	Output Charge	$V_{DS} = 13.7V, V_{GS} = 0V$		34		nC
$t_{d(on)}$	Turn On Delay Time	$V_{DS} = 15V, V_{GS} = 4.5V,$ $I_{DS} = 25A, R_G = 2\Omega$		11.4		ns
$t_r$	Rise Time			16		ns
$t_{d(off)}$	Turn Off Delay Time			27		ns
$t_f$	Fall Time			10.4		ns
<b>Diode Characteristics</b>						
$V_{SD}$	Diode Forward Voltage	$I_{SD} = 25A, V_{GS} = 0V$		0.8	1	V
$Q_{rr}$	Reverse Recovery Charge	$V_{DD} = 13.7V, I_F = 25A, di/dt = 300A/\mu s$		50		nC
$t_{rr}$	Reverse Recovery Time			33		ns

## THERMAL CHARACTERISTICS

( $T_A = 25^\circ\text{C}$  unless otherwise stated)

PARAMETER		MIN	TYP	MAX	UNIT
$R_{\theta JC}$	Thermal Resistance Junction to Case <sup>(1)</sup>			1.1	$^\circ\text{C/W}$
$R_{\theta JA}$	Thermal Resistance Junction to Ambient <sup>(1)(2)</sup>			49	$^\circ\text{C/W}$

- (1)  $R_{\theta JC}$  is determined with the device mounted on a 1-inch<sup>2</sup> (6.45-cm<sup>2</sup>), 2-oz. (0.071-mm thick) Cu pad on a 1.5-inch × 1.5-inch (3.81-cm × 3.81-cm), 0.06-inch (1.52-mm) thick FR4 PCB.  $R_{\theta JC}$  is specified by design, whereas  $R_{\theta JA}$  is determined by the user's board design.
- (2) Device mounted on FR4 material with 1-inch<sup>2</sup> (6.45-cm<sup>2</sup>), 2-oz. (0.071-mm thick) Cu.



M0137-01

Max  $R_{\theta JA} = 49^{\circ}\text{C/W}$   
when mounted on  
1 inch<sup>2</sup> (6.45 cm<sup>2</sup>) of  
2-oz. (0.071-mm thick)  
Cu.

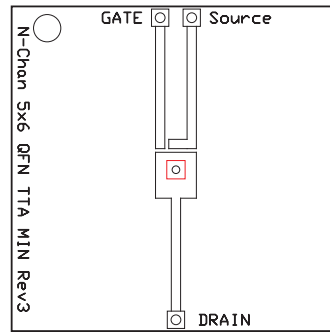

M0137-02

Max  $R_{\theta JA} = 124^{\circ}\text{C/W}$   
when mounted on  
minimum pad area of  
2-oz. (0.071-mm thick)  
Cu.

### TYPICAL MOSFET CHARACTERISTICS

$T_A = 25^{\circ}\text{C}$ , unless otherwise specified

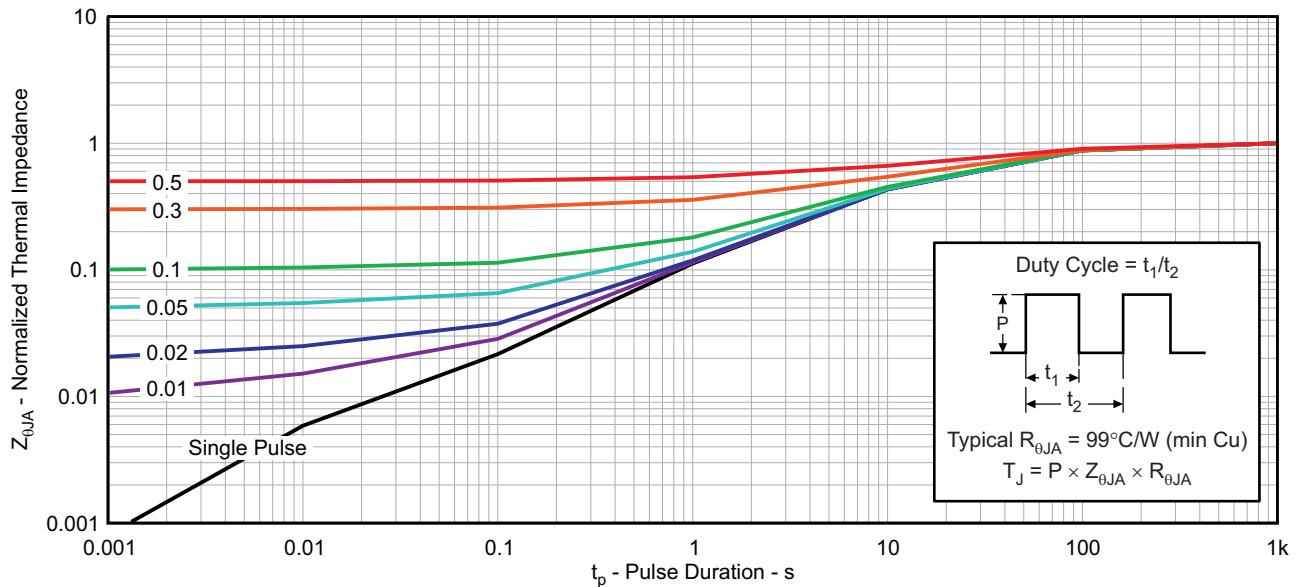

G012

Figure 1. Transient Thermal Impedance

**TYPICAL MOSFET CHARACTERISTICS (continued)**

$T_A = 25^\circ\text{C}$ , unless otherwise specified

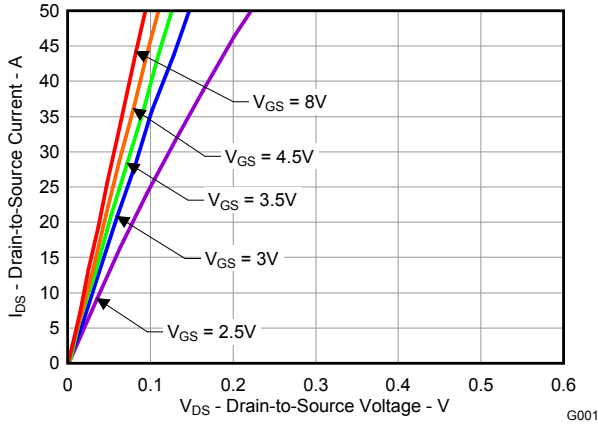

**Figure 2. Saturation Characteristics**

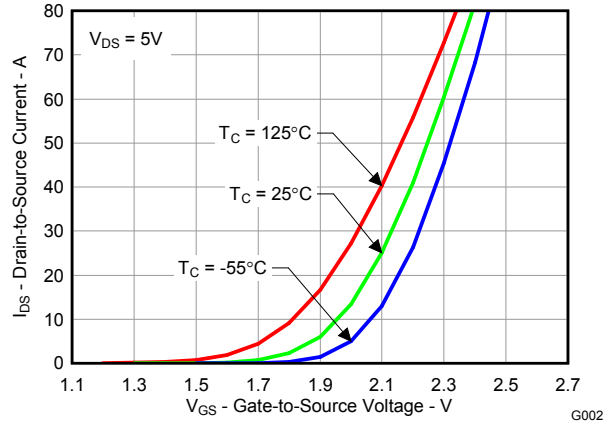

**Figure 3. Transfer Characteristics**

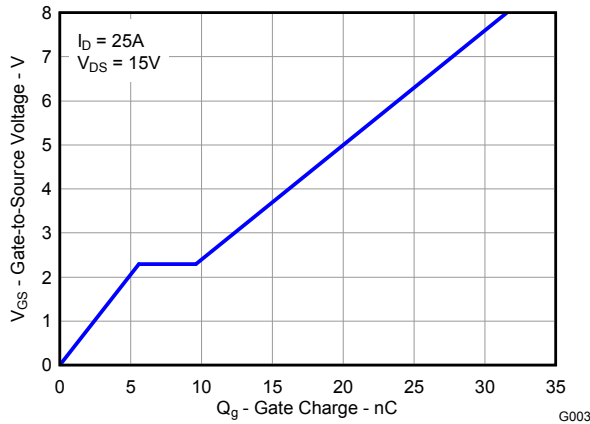

**Figure 4. Gate Charge**

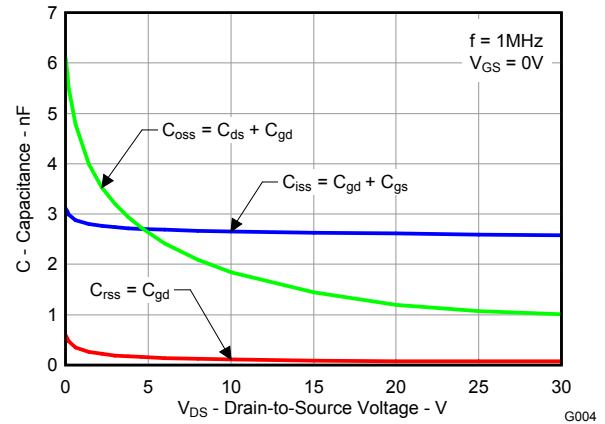

**Figure 5. Capacitance**

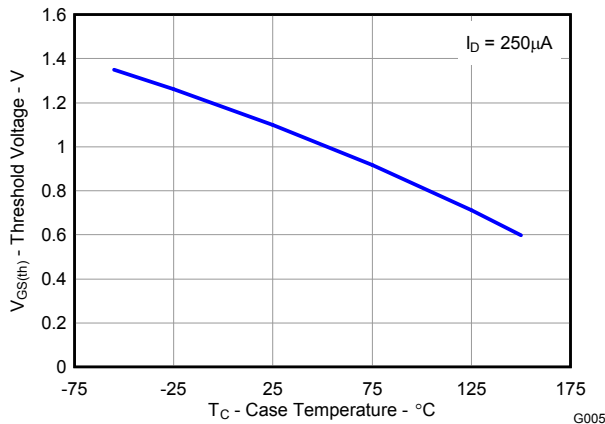

**Figure 6. Threshold Voltage vs. Temperature**

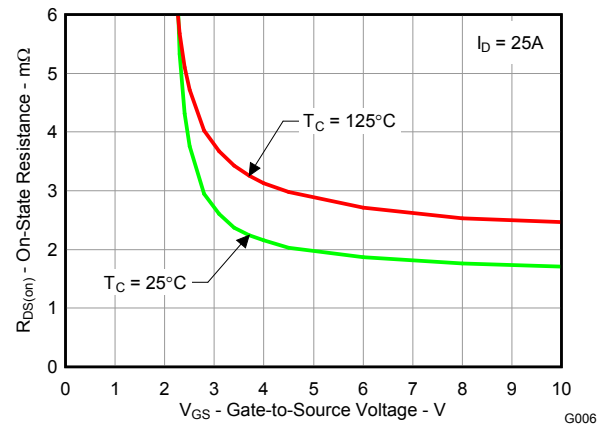

**Figure 7. On-State Resistance vs. Gate-to-Source Voltage**

TYPICAL MOSFET CHARACTERISTICS (continued)

$T_A = 25^\circ\text{C}$ , unless otherwise specified

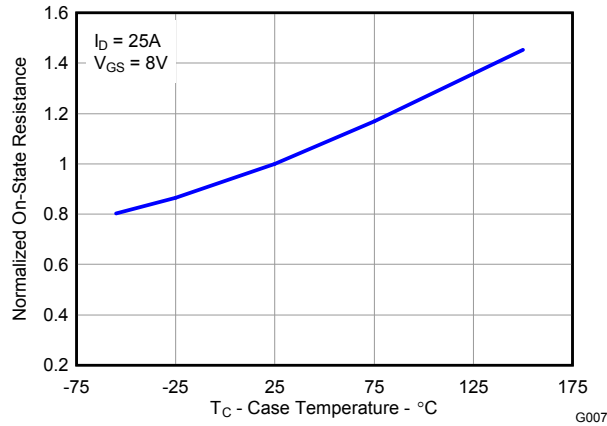

Figure 8. Normalized On-State Resistance vs. Temperature

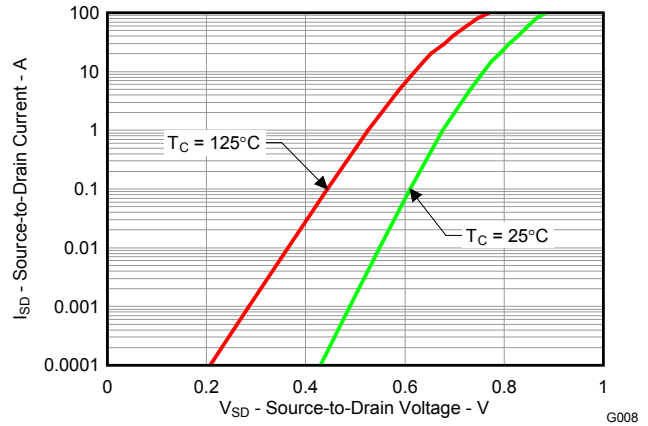

Figure 9. Typical Diode Forward Voltage

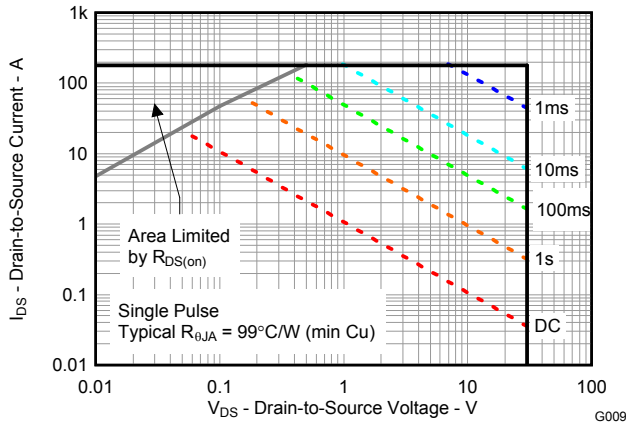

Figure 10. Maximum Safe Operating Area

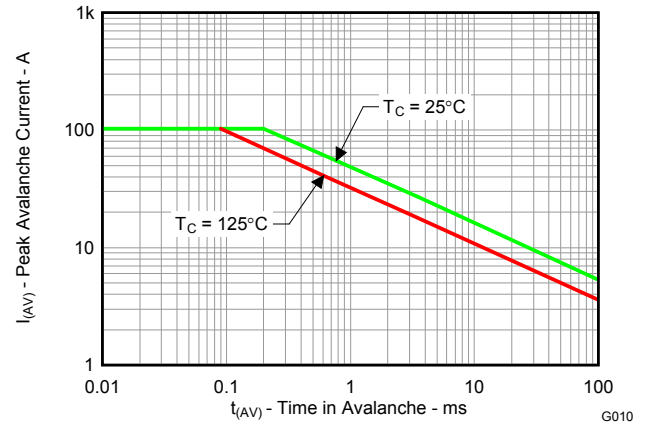

Figure 11. Single Pulse Unclamped Inductive Switching

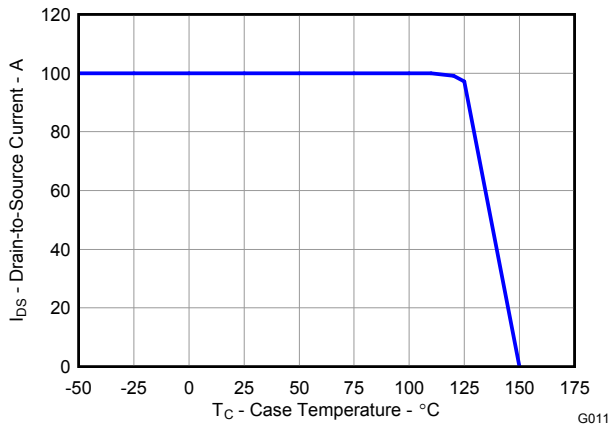

Figure 12. Maximum Drain Current vs. Temperature

**MECHANICAL DATA**

**Q5 Package Dimensions**



M0140-01

DIM	MILLIMETERS		INCHES	
	MIN	MAX	MIN	MAX
A	0.950	1.050	0.037	0.039
b	0.360	0.460	0.014	0.018
c	0.150	0.250	0.006	0.010
c1	0.150	0.250	0.006	0.010
D1	4.900	5.100	0.193	0.201
D2	4.320	4.520	0.170	0.178
E	4.900	5.100	0.193	0.201
E1	5.900	6.100	0.232	0.240
E2	3.920	4.12	0.154	0.162
e	1.27 TYP		0.050	
K	0.760		0.030	
L	0.510	0.710	0.020	0.028
$\theta$	0.00			

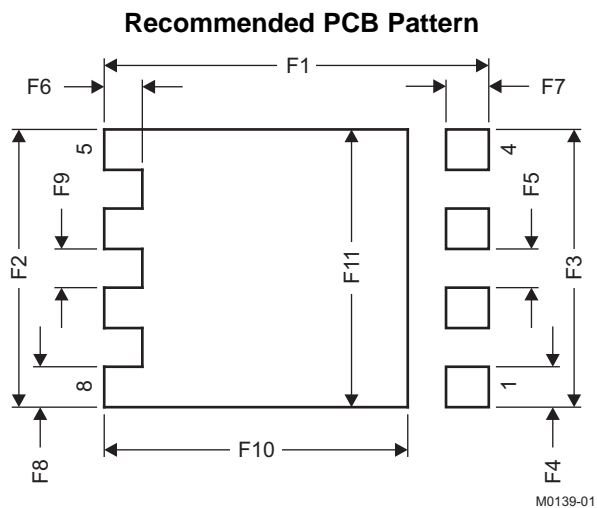

DIM	MILLIMETERS		INCHES	
	MIN	MAX	MIN	MAX
F1	6.205	6.305	0.244	0.248
F2	4.460	4.560	0.176	0.180
F3	4.460	4.560	0.176	0.180
F4	0.650	0.700	0.026	0.028
F5	0.620	0.670	0.024	0.026
F6	0.630	0.680	0.025	0.027
F7	0.700	0.800	0.028	0.031
F8	0.650	0.700	0.026	0.028
F9	0.620	0.670	0.024	0.026
F10	4.900	5.000	0.193	0.197
F11	4.460	4.560	0.176	0.180

For recommended circuit layout for PCB designs, see application note [SLPA005 – Reducing Ringing Through PCB Layout Techniques](#).

### Q5 Tape and Reel Information



M0138-01

### Notes:

- 10-sprocket hole-pitch cumulative tolerance  $\pm 0.2$
- Camber not to exceed 1mm in 100mm, noncumulative over 250mm
- Material: black static-dissipative polystyrene
- All dimensions are in mm (unless otherwise specified)
- Thickness:  $0.30 \pm 0.05$ mm
- MSL1 260°C (IR and convection) PbF reflow compatible

### REVISION HISTORY

---

**Changes from Original (January 2010) to Revision A** **Page**

- Changed the Abs Max Ratings table, Avalanche Energy, single pulse From:  $I_D = 85A$ ,  $L = 0.1mH$ ,  $R_G = 25\Omega$  Value = 361 To:  $I_D = 103A$ ,  $L = 0.1mH$ ,  $R_G = 25\Omega$  Value = 530 ..... [1](#)
  - Changed [Figure 11](#) ..... [5](#)
- 

**Changes from Revision A (February 2010) to Revision B** **Page**

- Deleted the Package Marking Information section ..... [7](#)
-



## TAPE AND REEL INFORMATION



### QUADRANT ASSIGNMENTS FOR PIN 1 ORIENTATION IN TAPE



\*All dimensions are nominal

Device	Package Type	Package Drawing	Pins	SPQ	Reel Diameter (mm)	Reel Width W1 (mm)	A0 (mm)	B0 (mm)	K0 (mm)	P1 (mm)	W (mm)	Pin1 Quadrant
CSD17303Q5	SON	DQH	8	2500	330.0	12.8	6.5	5.3	1.4	8.0	12.0	Q1

TAPE AND REEL BOX DIMENSIONS



\*All dimensions are nominal

Device	Package Type	Package Drawing	Pins	SPQ	Length (mm)	Width (mm)	Height (mm)
CSD17303Q5	SON	DQH	8	2500	335.0	335.0	32.0

## IMPORTANT NOTICE

Texas Instruments Incorporated and its subsidiaries (TI) reserve the right to make corrections, modifications, enhancements, improvements, and other changes to its products and services at any time and to discontinue any product or service without notice. Customers should obtain the latest relevant information before placing orders and should verify that such information is current and complete. All products are sold subject to TI's terms and conditions of sale supplied at the time of order acknowledgment.

TI warrants performance of its hardware products to the specifications applicable at the time of sale in accordance with TI's standard warranty. Testing and other quality control techniques are used to the extent TI deems necessary to support this warranty. Except where mandated by government requirements, testing of all parameters of each product is not necessarily performed.

TI assumes no liability for applications assistance or customer product design. Customers are responsible for their products and applications using TI components. To minimize the risks associated with customer products and applications, customers should provide adequate design and operating safeguards.

TI does not warrant or represent that any license, either express or implied, is granted under any TI patent right, copyright, mask work right, or other TI intellectual property right relating to any combination, machine, or process in which TI products or services are used. Information published by TI regarding third-party products or services does not constitute a license from TI to use such products or services or a warranty or endorsement thereof. Use of such information may require a license from a third party under the patents or other intellectual property of the third party, or a license from TI under the patents or other intellectual property of TI.

Reproduction of TI information in TI data books or data sheets is permissible only if reproduction is without alteration and is accompanied by all associated warranties, conditions, limitations, and notices. Reproduction of this information with alteration is an unfair and deceptive business practice. TI is not responsible or liable for such altered documentation. Information of third parties may be subject to additional restrictions.

Resale of TI products or services with statements different from or beyond the parameters stated by TI for that product or service voids all express and any implied warranties for the associated TI product or service and is an unfair and deceptive business practice. TI is not responsible or liable for any such statements.

TI products are not authorized for use in safety-critical applications (such as life support) where a failure of the TI product would reasonably be expected to cause severe personal injury or death, unless officers of the parties have executed an agreement specifically governing such use. Buyers represent that they have all necessary expertise in the safety and regulatory ramifications of their applications, and acknowledge and agree that they are solely responsible for all legal, regulatory and safety-related requirements concerning their products and any use of TI products in such safety-critical applications, notwithstanding any applications-related information or support that may be provided by TI. Further, Buyers must fully indemnify TI and its representatives against any damages arising out of the use of TI products in such safety-critical applications.

TI products are neither designed nor intended for use in military/aerospace applications or environments unless the TI products are specifically designated by TI as military-grade or "enhanced plastic." Only products designated by TI as military-grade meet military specifications. Buyers acknowledge and agree that any such use of TI products which TI has not designated as military-grade is solely at the Buyer's risk, and that they are solely responsible for compliance with all legal and regulatory requirements in connection with such use.

TI products are neither designed nor intended for use in automotive applications or environments unless the specific TI products are designated by TI as compliant with ISO/TS 16949 requirements. Buyers acknowledge and agree that, if they use any non-designated products in automotive applications, TI will not be responsible for any failure to meet such requirements.

Following are URLs where you can obtain information on other Texas Instruments products and application solutions:

### Products

Audio	<a href="http://www.ti.com/audio">www.ti.com/audio</a>
Amplifiers	<a href="http://amplifier.ti.com">amplifier.ti.com</a>
Data Converters	<a href="http://dataconverter.ti.com">dataconverter.ti.com</a>
DLP® Products	<a href="http://www.dlp.com">www.dlp.com</a>
DSP	<a href="http://dsp.ti.com">dsp.ti.com</a>
Clocks and Timers	<a href="http://www.ti.com/clocks">www.ti.com/clocks</a>
Interface	<a href="http://interface.ti.com">interface.ti.com</a>
Logic	<a href="http://logic.ti.com">logic.ti.com</a>
Power Mgmt	<a href="http://power.ti.com">power.ti.com</a>
Microcontrollers	<a href="http://microcontroller.ti.com">microcontroller.ti.com</a>
RFID	<a href="http://www.ti-rfid.com">www.ti-rfid.com</a>
RF/IF and ZigBee® Solutions	<a href="http://www.ti.com/lprf">www.ti.com/lprf</a>

### Applications

Communications and Telecom	<a href="http://www.ti.com/communications">www.ti.com/communications</a>
Computers and Peripherals	<a href="http://www.ti.com/computers">www.ti.com/computers</a>
Consumer Electronics	<a href="http://www.ti.com/consumer-apps">www.ti.com/consumer-apps</a>
Energy and Lighting	<a href="http://www.ti.com/energy">www.ti.com/energy</a>
Industrial	<a href="http://www.ti.com/industrial">www.ti.com/industrial</a>
Medical	<a href="http://www.ti.com/medical">www.ti.com/medical</a>
Security	<a href="http://www.ti.com/security">www.ti.com/security</a>
Space, Avionics and Defense	<a href="http://www.ti.com/space-avionics-defense">www.ti.com/space-avionics-defense</a>
Transportation and Automotive	<a href="http://www.ti.com/automotive">www.ti.com/automotive</a>
Video and Imaging	<a href="http://www.ti.com/video">www.ti.com/video</a>
Wireless	<a href="http://www.ti.com/wireless-apps">www.ti.com/wireless-apps</a>

TI E2E Community Home Page

[e2e.ti.com](http://e2e.ti.com)

Mailing Address: Texas Instruments, Post Office Box 655303, Dallas, Texas 75265  
Copyright © 2011, Texas Instruments Incorporated