

# Digital transistors (built-in resistors)

## DTC363EU / DTC363EK / DTC363ES

●Features

In addition to the features of regular digital transistors,

- 1) Low  $V_{O(on)}$  makes these transistors optimal for muting circuits.

$$V_{O(on)} = 40\text{mV (Typ.)}$$

$$(I_o/I_i = 50\text{mA}/2.5\text{mA})$$

- 2) They can be used at high current ( $I_c = 600\text{mA}$ ).

●Structure

NPN digital transistor  
(Built-in resistor type)

●Equivalent circuit

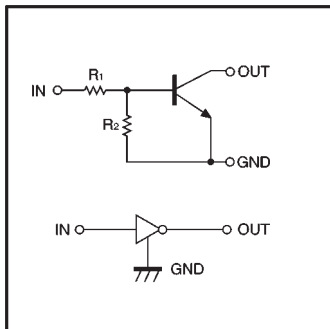

●External dimensions (Units: mm)

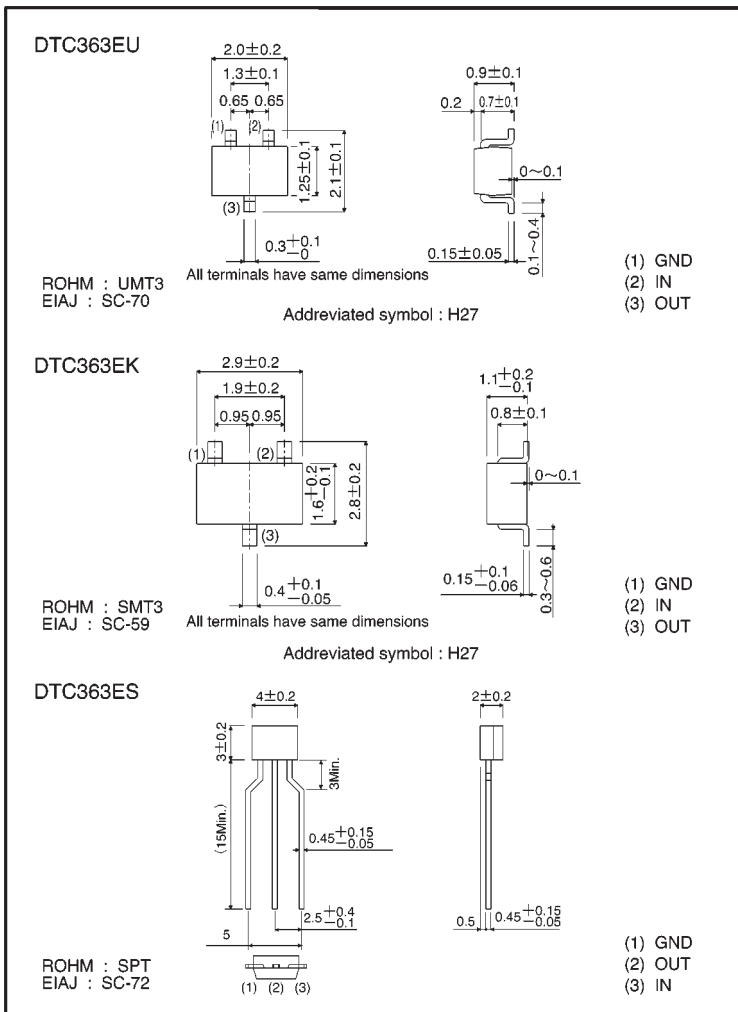

● Absolute maximum ratings (Ta = 25°C)

Parameter	Symbol	Limits(DTC363E□)			Unit
		U	K	S	
Supply voltage	V <sub>CC</sub>	20			V
Input voltage	V <sub>IN</sub>	-10~+10			V
Output current	I <sub>c</sub>	600			mA
Power dissipation	P <sub>d</sub>	200	300		mW
Junction temperature	T <sub>j</sub>	150			°C
Storage temperature	T <sub>stg</sub>	-55~+150			°C

● Electrical characteristics (Ta = 25°C)

Parameter	Symbol	Min.	Typ.	Max.	Unit	Conditions
Input voltage	V <sub>I(off)</sub>	—	—	0.5	V	V <sub>CC</sub> =5V, I <sub>o</sub> =100 μA
	V <sub>I(on)</sub>	2	—	—		V <sub>o</sub> =0.3V, I <sub>o</sub> =10mA
Output voltage	V <sub>O(on)</sub>	—	40	80	mV	I <sub>o</sub> /I <sub>i</sub> =50mA/2.5mA
Input current	I <sub>i</sub>	—	—	1.3	mA	V <sub>i</sub> =5V
Output current	I <sub>o(off)</sub>	—	—	0.5	μA	V <sub>CC</sub> =15V, V <sub>i</sub> =0V
DC current gain	G <sub>i</sub>	70	—	—	—	V <sub>o</sub> =5V, I <sub>o</sub> =50mA
Input resistance	R <sub>i</sub>	4.76	6.8	8.84	kΩ	—
Resistance ratio	R <sub>2</sub> /R <sub>1</sub>	0.8	1	1.2	—	—
Transition frequency	f <sub>T</sub>	—	200	—	MHz	V <sub>CE</sub> =10V, I <sub>E</sub> =-50mA, f=100MHz *
Output "ON" resistance	R <sub>on</sub>	—	1.1	—	Ω	V <sub>i</sub> =7V, R <sub>L</sub> =1kΩ, f=1kHz

\* Transition frequency of the device

● Packaging specifications

Part No.	Package	UMT3	SMT3	SPT
	Packaging type	Taping	Taping	Taping
	Code	T106	T146	TP
	Basic ordering unit (pieces)	3000	3000	5000
DTC363EU		○	—	—
DTC363EK		—	○	—
DTC363ES		—	—	○

● R<sub>on</sub> measurement circuit

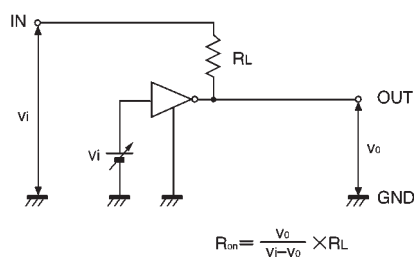

Fig.1 Input "ON" resistance (R<sub>on</sub>) measurement circuit

●Electrical characteristic curves

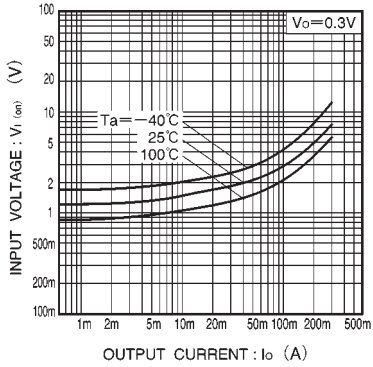

Fig.2 Input voltage vs. output current (ON characteristics)

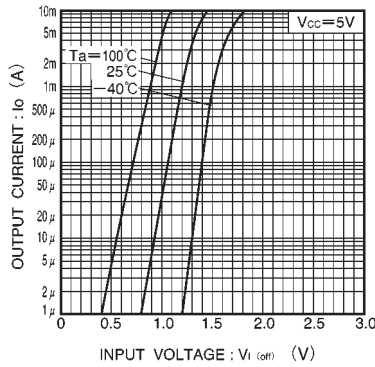

Fig.3 Output current vs. input voltage (OFF characteristics)

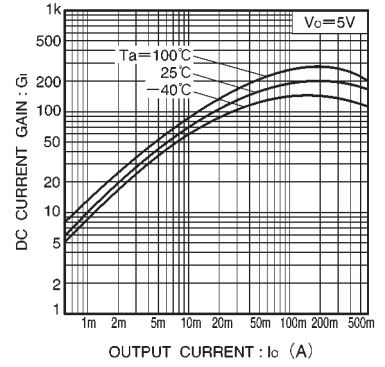

Fig.4 DC current gain vs. output current

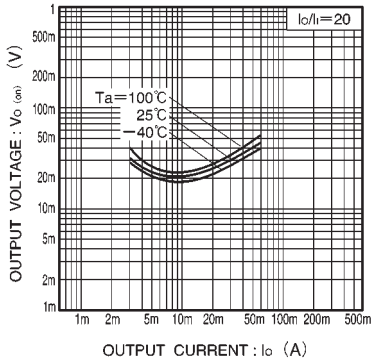

Fig.5 Output voltage vs. output current

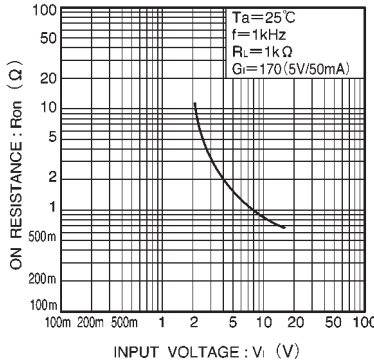

Fig.6 "ON" resistance vs. input voltage