



# STE24NA100

## N - CHANNEL 1000V - 0.35Ω - 24A - ISOTOP FAST POWER MOSFET

TYPE	V <sub>DSS</sub>	R <sub>DS(on)</sub>	I <sub>D</sub>
STE24NA100	1000 V	< 0.385 Ω	24 A

- TYPICAL R<sub>DS(on)</sub> = 0.35 Ω
- ± 30V GATE TO SOURCE VOLTAGE RATING
- 100% AVALANCHE TESTED
- LOW INTRINSIC CAPACITANCE
- GATE CHARGE MINIMIZED
- REDUCED VOLTAGE SPREAD

### APPLICATIONS

- HIGH CURRENT, HIGH SPEED SWITCHING
- SWITCH MODE POWER SUPPLY (SMPS)
- DC-AC CONVERTER FOR WELDING EQUIPMENT AND UNINTERRUPTABLE POWER SUPPLY AND MOTOR DRIVE

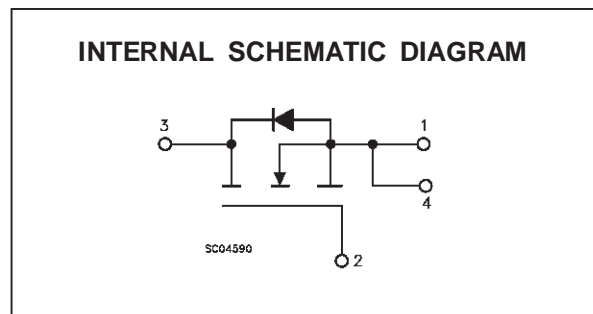
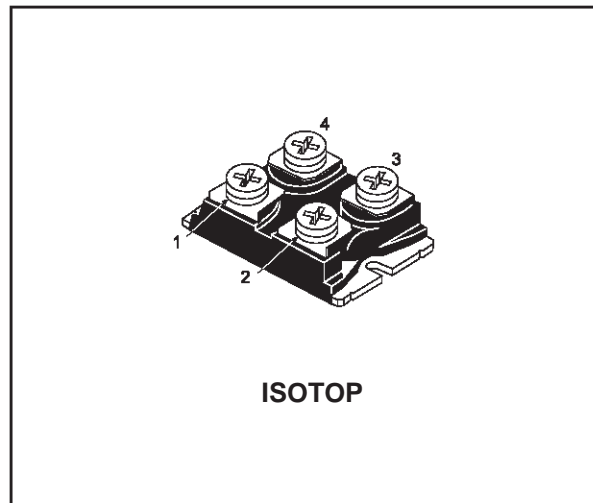

### ABSOLUTE MAXIMUM RATINGS

Symbol	Parameter	Value	Unit
V <sub>DS</sub>	Drain-source Voltage (V <sub>GS</sub> = 0)	1000	V
V <sub>DGR</sub>	Drain- gate Voltage (R <sub>GS</sub> = 20 kΩ)	1000	V
V <sub>GS</sub>	Gate-source Voltage	± 30	V
I <sub>D</sub>	Drain Current (continuous) at T <sub>c</sub> = 25 °C	24	A
I <sub>D</sub>	Drain Current (continuous) at T <sub>c</sub> = 100 °C	15	A
I <sub>DM</sub> (•)	Drain Current (pulsed)	96	A
P <sub>tot</sub>	Total Dissipation at T <sub>c</sub> = 25 °C	450	W
	Derating Factor	3.6	W/°C
T <sub>stg</sub>	Storage Temperature	-55 to 150	°C
T <sub>j</sub>	Max. Operating Junction Temperature	150	°C
V <sub>ISO</sub>	Insulation Withstand Voltage (AC-RMS)	2500	V

(•) Pulse width limited by safe operating area

## STE24NA100

### THERMAL DATA

$R_{thj-case}$	Thermal Resistance Junction-case	Max	0.27	°C/W
$R_{thc-h}$	Thermal Resistance Case-heatsink With Conductive Grease Applied	Max	0.05	°C/W

### AVALANCHE CHARACTERISTICS

Symbol	Parameter	Max Value	Unit
$I_{AR}$	Avalanche Current, Repetitive or Not-Repetitive (pulse width limited by $T_j$ max)	12	A
$E_{AS}$	Single Pulse Avalanche Energy (starting $T_j = 25\text{ °C}$ , $I_D = I_{AR}$ , $V_{DD} = 50\text{ V}$ )	2000	mJ

### ELECTRICAL CHARACTERISTICS ( $T_{case} = 25\text{ °C}$ unless otherwise specified)

OFF

Symbol	Parameter	Test Conditions	Min.	Typ.	Max.	Unit
$V_{(BR)DSS}$	Drain-source Breakdown Voltage	$I_D = 500\text{ }\mu\text{A}$ $V_{GS} = 0$	1000			V
$I_{DSS}$	Zero Gate Voltage Drain Current ( $V_{GS} = 0$ )	$V_{DS} = \text{Max Rating}$ $V_{DS} = \text{Max Rating}$ $T_c = 125\text{ °C}$			50 250	$\mu\text{A}$ $\mu\text{A}$
$I_{GSS}$	Gate-body Leakage Current ( $V_{DS} = 0$ )	$V_{GS} = \pm 30\text{ V}$			$\pm 400$	nA

ON (\*)

Symbol	Parameter	Test Conditions	Min.	Typ.	Max.	Unit
$V_{GS(th)}$	Gate Threshold Voltage	$V_{DS} = V_{GS}$ $I_D = 1\text{ mA}$	2.25	3	3.75	V
$R_{DS(on)}$	Static Drain-source On Resistance	$V_{GS} = 10\text{ V}$ $I_D = 12\text{ A}$		0.35	0.385	$\Omega$
$I_{D(on)}$	On State Drain Current	$V_{DS} > I_{D(on)} \times R_{DS(on)max}$ $V_{GS} = 10\text{ V}$	24			A

### DYNAMIC

Symbol	Parameter	Test Conditions	Min.	Typ.	Max.	Unit
$g_{fs}$ (*)	Forward Transconductance	$V_{DS} > I_{D(on)} \times R_{DS(on)max}$ $I_D = 12\text{ A}$	15			S
$C_{iss}$	Input Capacitance	$V_{DS} = 25\text{ V}$ $f = 1\text{ MHz}$ $V_{GS} = 0$		14000	19000	pF
$C_{oss}$	Output Capacitance			1200	1600	pF
$C_{rss}$	Reverse Transfer Capacitance			300	390	pF

**ELECTRICAL CHARACTERISTICS** (continued)

**SWITCHING ON**

Symbol	Parameter	Test Conditions	Min.	Typ.	Max.	Unit
$t_{d(on)}$	Turn-on Time	$V_{DD} = 500\text{ V}$ $I_D = 12\text{ A}$		40	56	ns
$t_r$	Rise Time	$R_G = 4.7\ \Omega$ $V_{GS} = 10\text{ V}$ (see test circuit, figure 3)		55	77	ns
$Q_g$	Total Gate Charge	$V_{DD} = 800\text{ V}$ $I_D = 24\text{ A}$ $V_{GS} = 10\text{ V}$		470	660	nC
$Q_{gs}$	Gate-Source Charge			43		nC
$Q_{gd}$	Gate-Drain Charge			226		nC

**SWITCHING OFF**

Symbol	Parameter	Test Conditions	Min.	Typ.	Max.	Unit
$t_{r(Voff)}$	Off-voltage Rise Time	$V_{DD} = 800\text{ V}$ $I_D = 24\text{ A}$		110	154	ns
$t_f$	Fall Time	$R_G = 4.7\ \Omega$ $V_{GS} = 10\text{ V}$		25	35	ns
$t_c$	Cross-over Time	(see test circuit, figure 5)		150	210	ns

**SOURCE DRAIN DIODE**

Symbol	Parameter	Test Conditions	Min.	Typ.	Max.	Unit
$I_{SD}$	Source-drain Current				24	A
$I_{SDM}(\bullet)$	Source-drain Current (pulsed)				96	A
$V_{SD}(\ast)$	Forward On Voltage	$I_{SD} = 24\text{ A}$ $V_{GS} = 0$			1.6	V
$t_{rr}$	Reverse Recovery Time	$I_{SD} = 24\text{ A}$ $di/dt = 100\text{ A}/\mu\text{s}$ $V_{DD} = 100\text{ V}$ $T_j = 150\text{ }^\circ\text{C}$ (see test circuit, figure 5)		1.4		$\mu\text{s}$
$Q_{rr}$	Reverse Recovery Charge			41		$\mu\text{C}$
$I_{RRM}$	Reverse Recovery Current			60		A

(\*) Pulsed: Pulse duration = 300  $\mu\text{s}$ , duty cycle 1.5 %  
 (•) Pulse width limited by safe operating area

**Safe Operating Area**

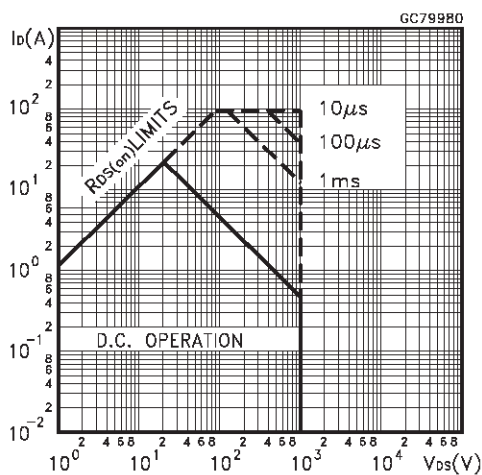

**Thermal Impedance**

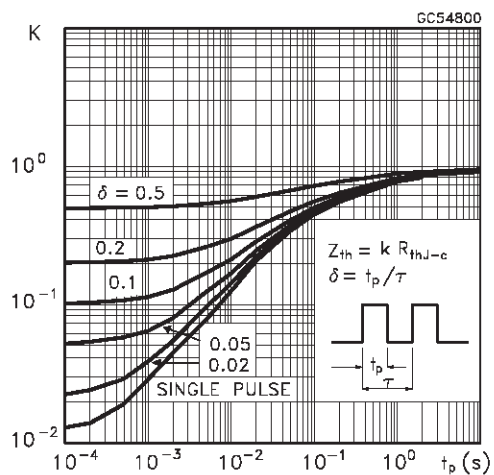

Output Characteristics

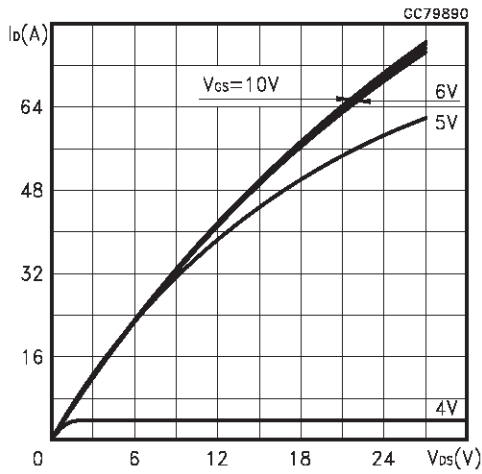

Transfer Characteristics

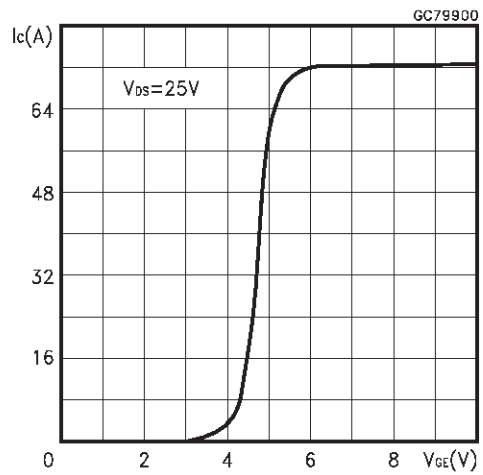

Transconductance

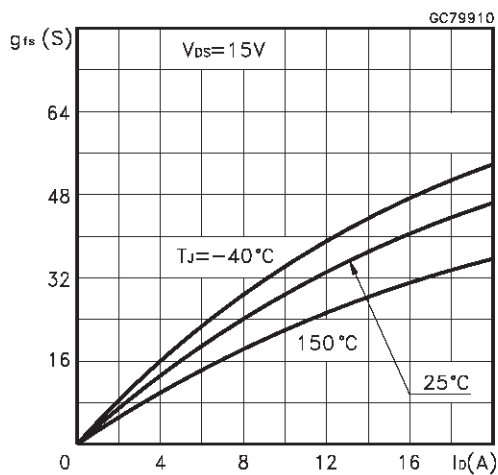

Static Drain-source On Resistance

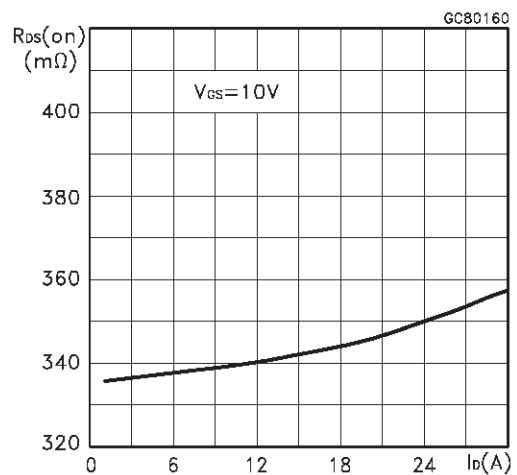

Gate Charge vs Gate-source Voltage

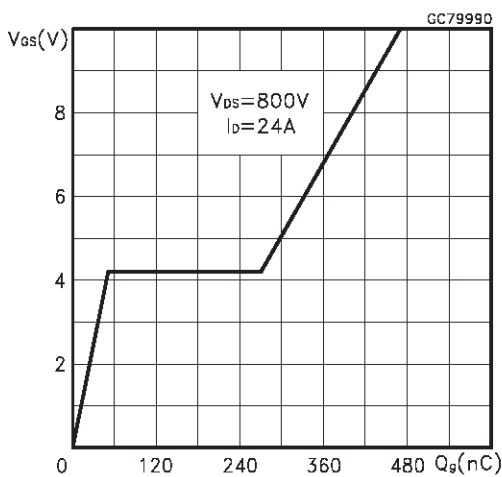

Capacitance Variations

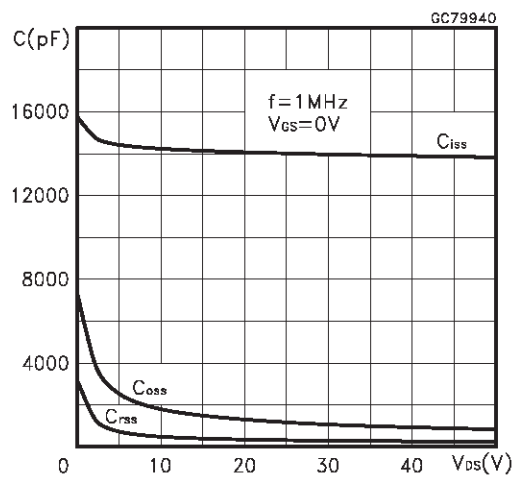

Normalized Gate Threshold Voltage vs Temperature

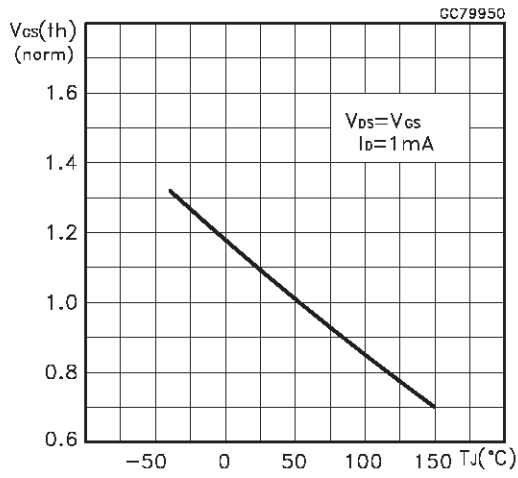

Normalized On Resistance vs Temperature

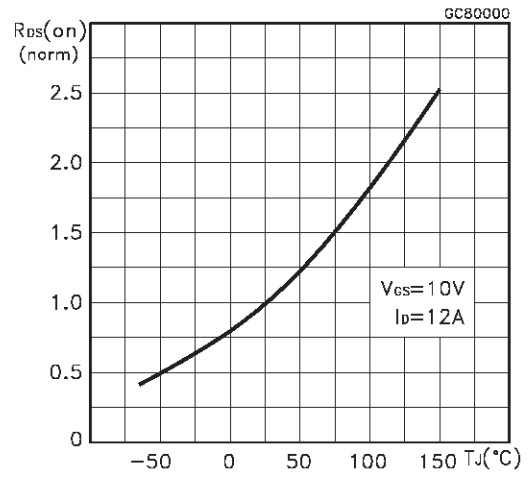

Source-drain Diode Forward Characteristics

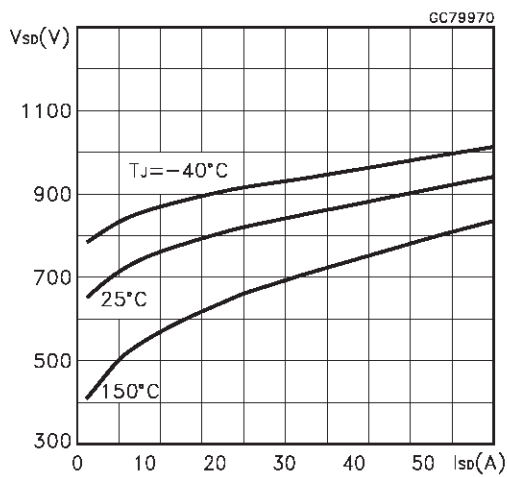

Fig. 1: Unclamped Inductive Load Test Circuit



Fig. 2: Unclamped Inductive Waveform



Fig. 3: Switching Times Test Circuits For Resistive Load



Fig. 4: Gate Charge test Circuit

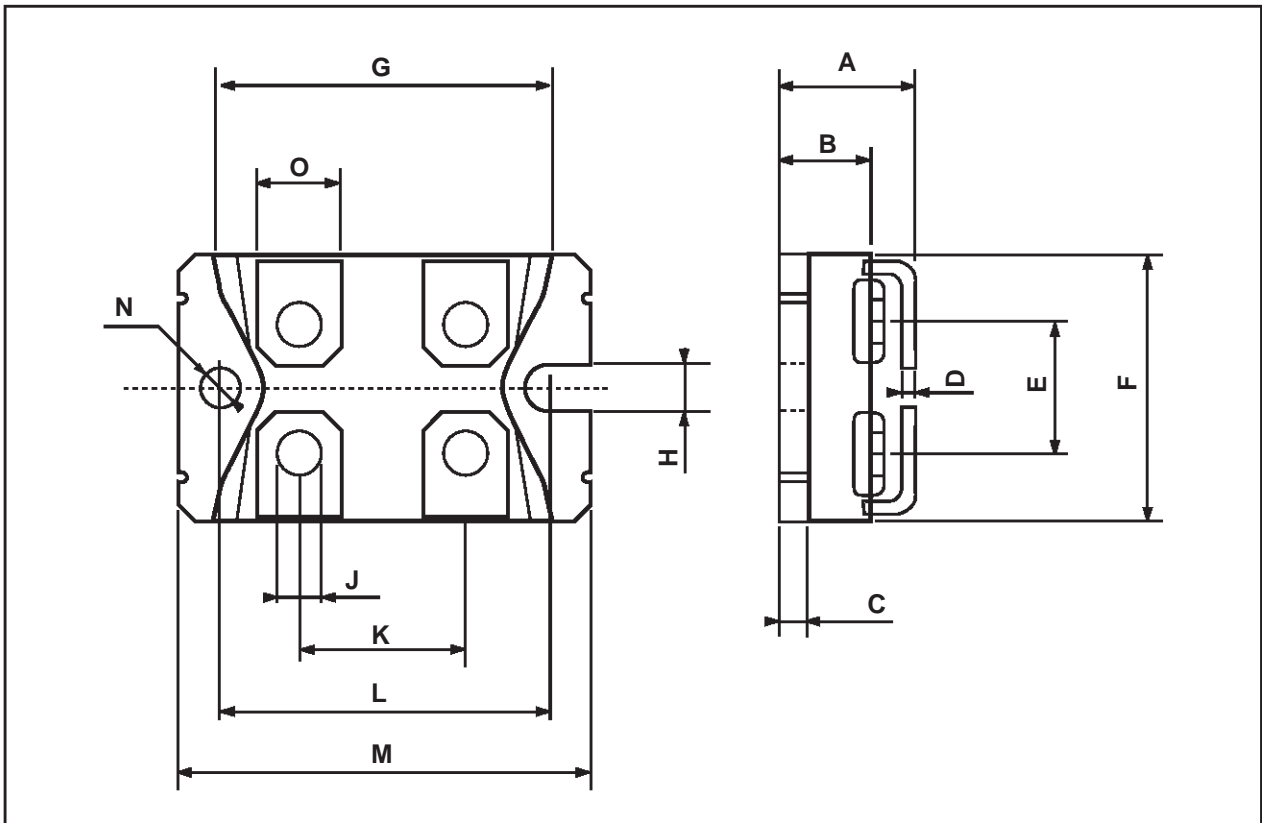

Fig. 5: Test Circuit For Inductive Load Switching And Diode Recovery Times



## ISOTOP MECHANICAL DATA

DIM.	mm			inch		
	MIN.	TYP.	MAX.	MIN.	TYP.	MAX.
A	11.8		12.2	0.466		0.480
B	8.9		9.1	0.350		0.358
C	1.95		2.05	0.076		0.080
D	0.75		0.85	0.029		0.033
E	12.6		12.8	0.496		0.503
F	25.15		25.5	0.990		1.003
G	31.5		31.7	1.240		1.248
H	4			0.157		
J	4.1		4.3	0.161		0.169
K	14.9		15.1	0.586		0.594
L	30.1		30.3	1.185		1.193
M	37.8		38.2	1.488		1.503
N	4			0.157		
O	7.8		8.2	0.307		0.322



Information furnished is believed to be accurate and reliable. However, STMicroelectronics assumes no responsibility for the consequences of use of such information nor for any infringement of patents or other rights of third parties which may result from its use. No license is granted by implication or otherwise under any patent or patent rights of STMicroelectronics. Specification mentioned in this publication are subject to change without notice. This publication supersedes and replaces all information previously supplied. STMicroelectronics products are not authorized for use as critical components in life support devices or systems without express written approval of STMicroelectronics.

The ST logo is a trademark of STMicroelectronics

© 1998 STMicroelectronics – Printed in Italy – All Rights Reserved  
STMicroelectronics GROUP OF COMPANIES

Australia - Brazil - Canada - China - France - Germany - Italy - Japan - Korea - Malaysia - Malta - Mexico - Morocco - The Netherlands -  
Singapore - Spain - Sweden - Switzerland - Taiwan - Thailand - United Kingdom - U.S.A.

<http://www.st.com>