

FDD4N60NZ
N-Channel MOSFET
600V, 3.4A, 2.5Ω

Features

- $R_{DS(on)} = 1.9\Omega$ (Typ.) @ $V_{GS} = 10V, I_D = 1.7A$
- Low Gate Charge (Typ. 8.3nC)
- Low C_{rss} (Typ. 3.7pF)
- Fast Switching
- 100% Avalanche Tested
- Improved dv/dt Capability
- ESD Improved Capability
- RoHS Compliant



Description

These N-Channel enhancement mode power field effect transistors are produced using Fairchild's proprietary, planar stripe, DMOS technology.

This advanced technology has been especially tailored to minimize on-state resistance, provide superior switching performance, and withstand high energy pulse in the avalanche and commutation mode. These devices are well suited for high efficient switching mode power supplies and active power factor correction.

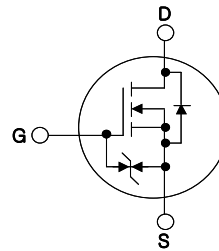
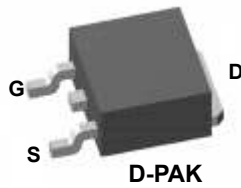

MOSFET Maximum Ratings $T_C = 25^\circ\text{C}$ unless otherwise noted*

Symbol	Parameter	FDD4N60NZ	Units
V_{DSS}	Drain to Source Voltage	600	V
V_{GSS}	Gate to Source Voltage	±25	V
I_D	Drain Current	-Continuous ($T_C = 25^\circ\text{C}$)	3.4
		-Continuous ($T_C = 100^\circ\text{C}$)	2
I_{DM}	Drain Current	- Pulsed (Note 1)	13.6
E_{AS}	Single Pulsed Avalanche Energy	(Note 2)	179.2
I_{AR}	Avalanche Current	(Note 1)	3.4
E_{AR}	Repetitive Avalanche Energy	(Note 1)	11.4
dv/dt	Peak Diode Recovery dv/dt	(Note 3)	5
P_D	Power Dissipation	($T_C = 25^\circ\text{C}$)	114
		- Derate above 25°C	0.9
T_J, T_{STG}	Operating and Storage Temperature Range	-55 to +150	$^\circ\text{C}$
T_L	Maximum Lead Temperature for Soldering Purpose, 1/8" from Case for 5 Seconds	300	$^\circ\text{C}$

Thermal Characteristics

Symbol	Parameter	FDD4N60NZ	Units
$R_{\theta JC}$	Thermal Resistance, Junction to Case	1.1	$^\circ\text{C}/\text{W}$
$R_{\theta JA}$	Thermal Resistance, Junction to Ambient	110	

Package Marking and Ordering Information

Device Marking	Device	Package	Reel Size	Tape Width	Quantity
FDD4N60NZ	FDD4N60NZ	D-PAK	380mm	16mm	2500

Electrical Characteristics $T_C = 25^\circ\text{C}$ unless otherwise noted

Symbol	Parameter	Test Conditions	Min.	Typ.	Max.	Units
--------	-----------	-----------------	------	------	------	-------

Off Characteristics

BV_{DSS}	Drain to Source Breakdown Voltage	$I_D = 250\mu\text{A}, V_{GS} = 0\text{V}, T_J = 25^\circ\text{C}$	600	-	-	V
$\frac{\Delta BV_{DSS}}{\Delta T_J}$	Breakdown Voltage Temperature Coefficient	$I_D = 250\mu\text{A}$, Referenced to 25°C	-	0.6	-	$\text{V}/^\circ\text{C}$
I_{DSS}	Zero Gate Voltage Drain Current	$V_{DS} = 600\text{V}, V_{GS} = 0\text{V}$ $V_{DS} = 480\text{V}, T_C = 125^\circ\text{C}$	-	-	50 100	μA
I_{GSS}	Gate to Body Leakage Current	$V_{GS} = \pm 25\text{V}, V_{DS} = 0\text{V}$	-	-	± 10	μA

On Characteristics

$V_{GS(th)}$	Gate Threshold Voltage	$V_{GS} = V_{DS}, I_D = 250\mu\text{A}$	3.0	-	5.0	V
$R_{DS(on)}$	Static Drain to Source On Resistance	$V_{GS} = 10\text{V}, I_D = 1.7\text{A}$	-	1.9	2.5	Ω
g_{FS}	Forward Transconductance	$V_{DS} = 20\text{V}, I_D = 1.7\text{A}$ (Note 4)	-	3.4	-	S

Dynamic Characteristics

C_{iss}	Input Capacitance	$V_{DS} = 25\text{V}, V_{GS} = 0\text{V}$ $f = 1\text{MHz}$	-	385	510	pF
C_{oss}	Output Capacitance		-	40	60	pF
C_{rss}	Reverse Transfer Capacitance		-	3.7	5	pF
$Q_{g(tot)}$	Total Gate Charge at 10V	$V_{DS} = 480\text{V}, I_D = 3.4\text{A}$ $V_{GS} = 10\text{V}$ (Note 4, 5)	-	8.3	10.8	nC
Q_{gs}	Gate to Source Gate Charge		-	2.1	-	nC
Q_{gd}	Gate to Drain "Miller" Charge		-	3.3	-	nC

Switching Characteristics

$t_{d(on)}$	Turn-On Delay Time	$V_{DD} = 300\text{V}, I_D = 3.4\text{A}$ $V_{GS} = 10\text{V}, R_G = 25\Omega$ (Note 4, 5)	-	12.7	35.4	ns
t_r	Turn-On Rise Time		-	15.1	40.2	ns
$t_{d(off)}$	Turn-Off Delay Time		-	30.2	70.4	ns
t_f	Turn-Off Fall Time		-	12.8	35.6	ns

Drain-Source Diode Characteristics

I_S	Maximum Continuous Drain to Source Diode Forward Current	-	-	3.4	A	
I_{SM}	Maximum Pulsed Drain to Source Diode Forward Current	-	-	13.6	A	
V_{SD}	Drain to Source Diode Forward Voltage	$V_{GS} = 0\text{V}, I_{SD} = 3.4\text{A}$	-	-	1.4	V
t_{rr}	Reverse Recovery Time	$V_{GS} = 0\text{V}, I_{SD} = 3.4\text{A}$	-	168	-	ns
Q_{rr}	Reverse Recovery Charge	$di_F/dt = 100\text{A}/\mu\text{s}$ (Note 4)	-	0.7	-	μC

Notes:

1. Repetitive Rating: Pulse width limited by maximum junction temperature
2. $L = 31\text{mH}, I_{AS} = 3.4\text{A}, V_{DD} = 50\text{V}, R_G = 25\Omega$, Starting $T_J = 25^\circ\text{C}$
3. $I_{SD} \leq 3.4\text{A}, di/dt \leq 200\text{A}/\mu\text{s}, V_{DD} \leq BV_{DSS}$, Starting $T_J = 25^\circ\text{C}$
4. Pulse Test: Pulse width $\leq 300\mu\text{s}$, Dual Cycle $\leq 2\%$
5. Essentially Independent of Operating Temperature Typical Characteristics

Typical Performance Characteristics

Figure 1. On-Region Characteristics

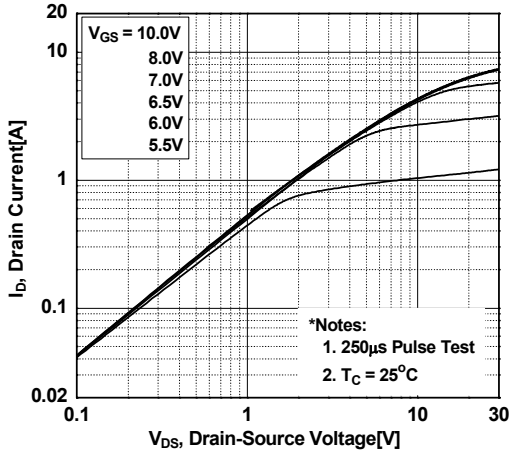

Figure 2. Transfer Characteristics

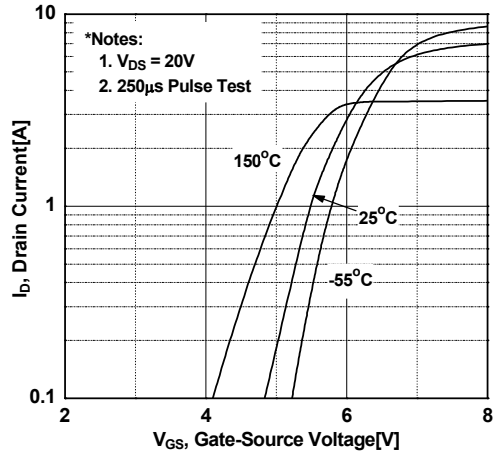

Figure 3. On-Resistance Variation vs. Drain Current and Gate Voltage

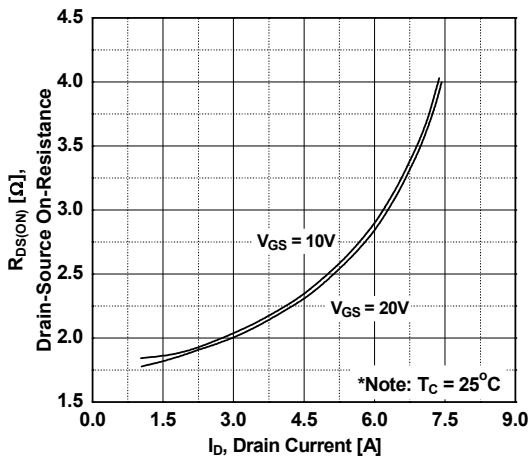

Figure 4. Body Diode Forward Voltage Variation vs. Source Current and Temperature

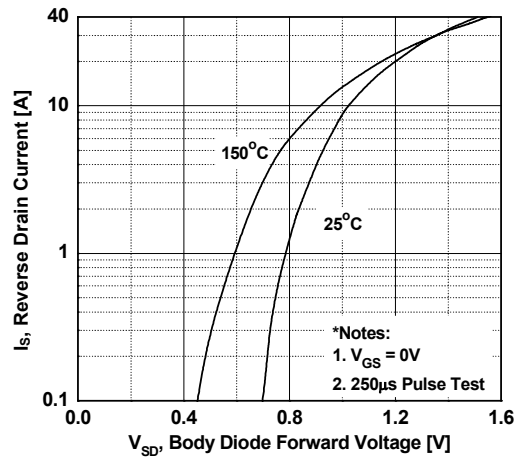

Figure 5. Capacitance Characteristics

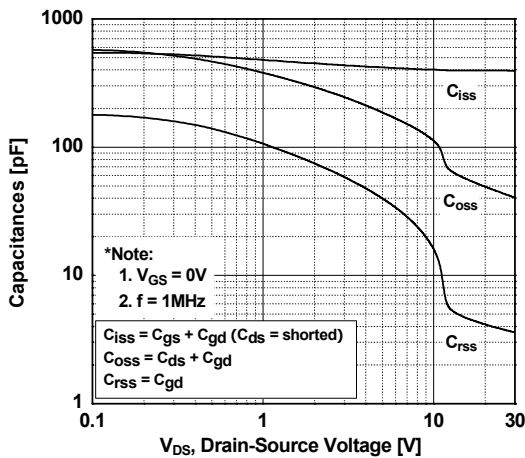
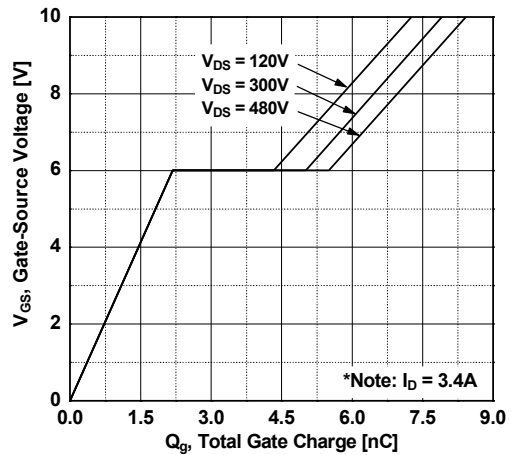

Figure 6. Gate Charge Characteristics



Typical Performance Characteristics (Continued)

Figure 7. Breakdown Voltage Variation vs. Temperature

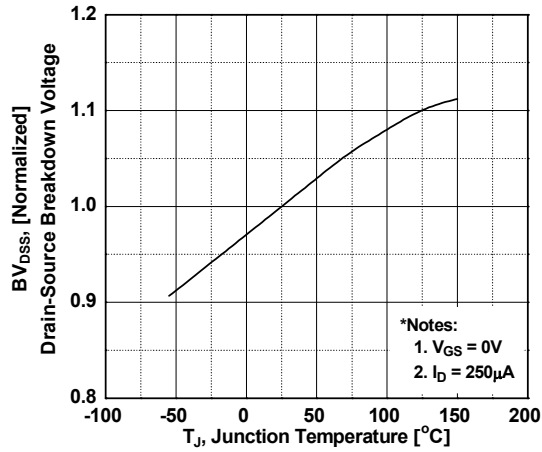

Figure 8. On-Resistance Variation vs. Temperature

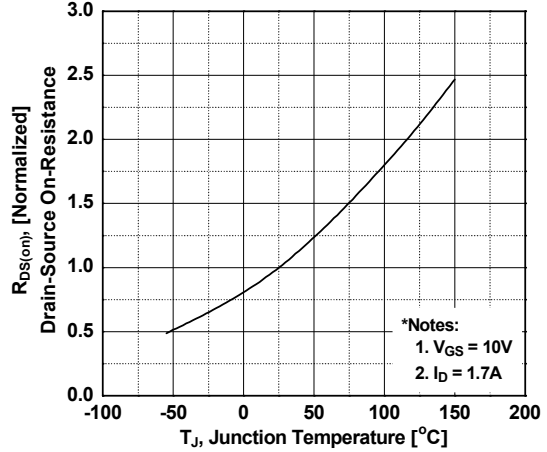

Figure 9. Maximum Safe Operating Area vs. Case Temperature

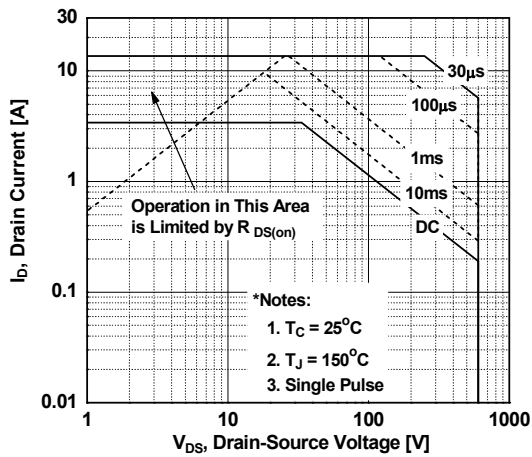

Figure 10. Maximum Drain Current

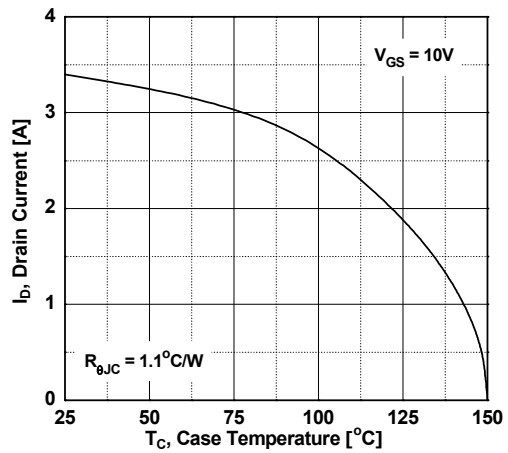
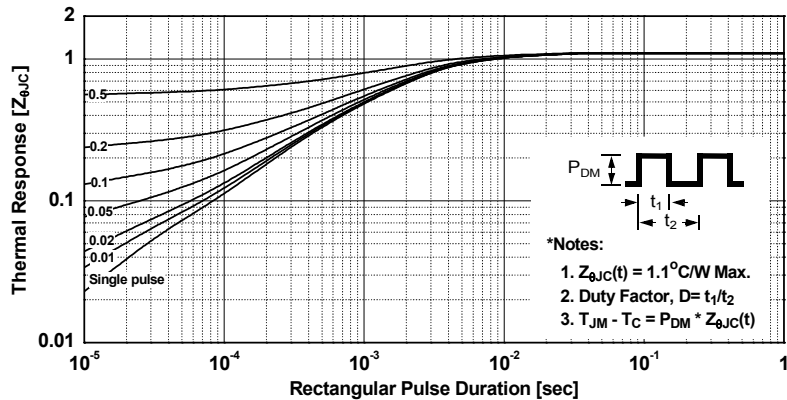
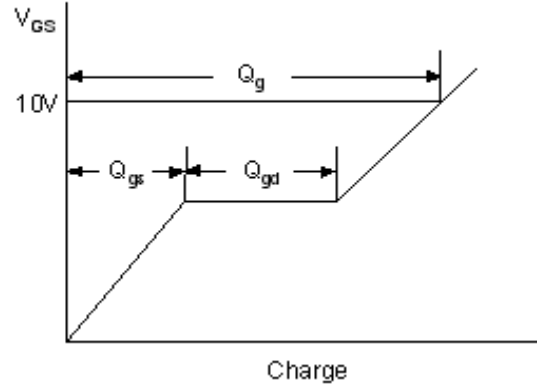
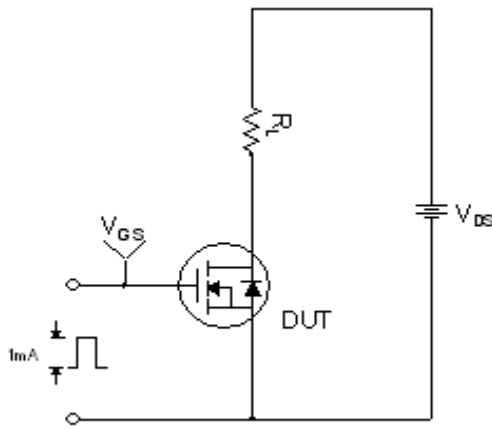

Figure 11. Transient Thermal Response Curve



Gate Charge Test Circuit & Waveform



Resistive Switching Test Circuit & Waveforms

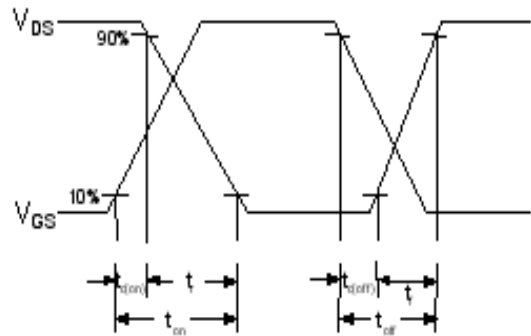
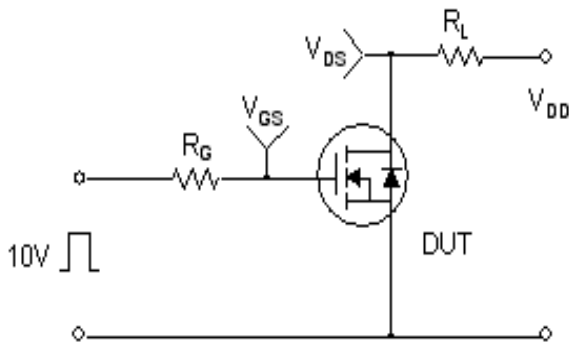

Unclamped Inductive Switching Test Circuit & Waveforms

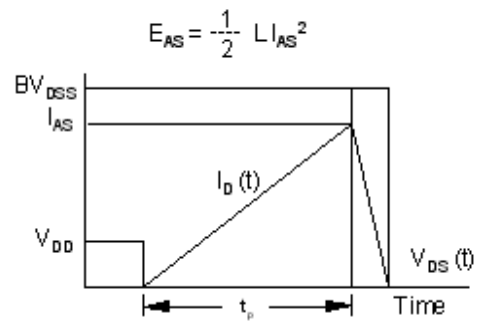
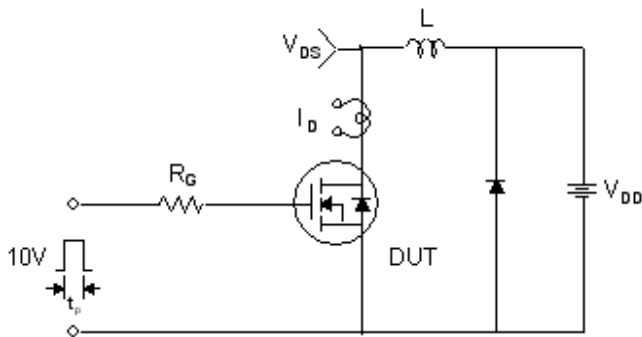

Peak Diode Recovery dv/dt Test Circuit & Waveforms

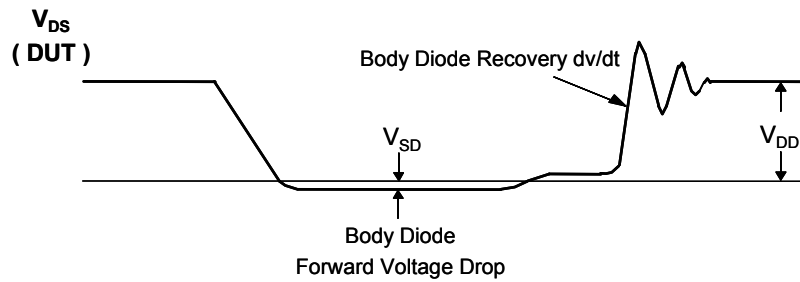
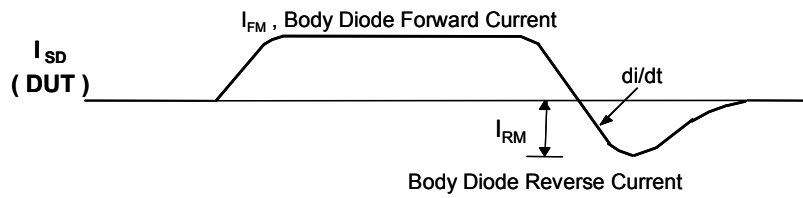
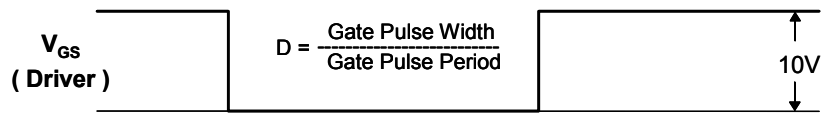
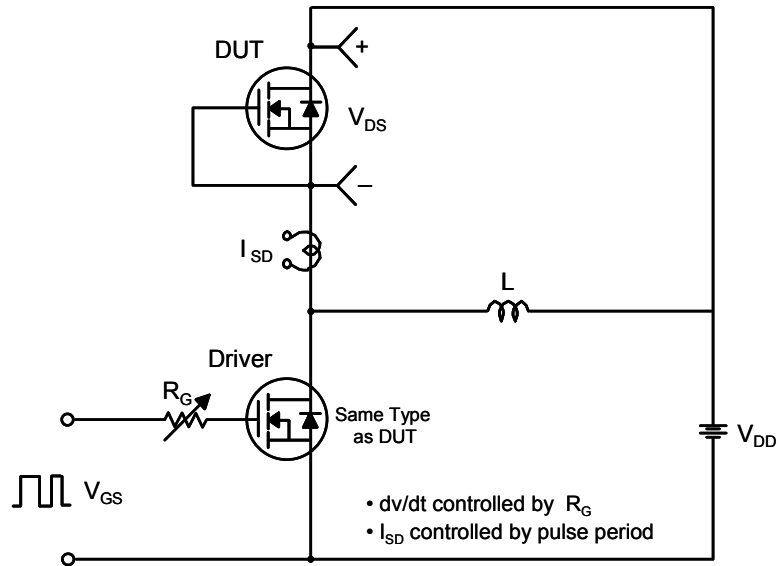

Mechanical Dimensions

D-PAK

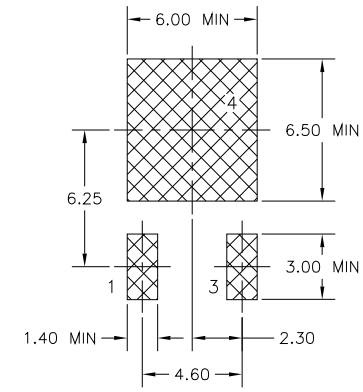
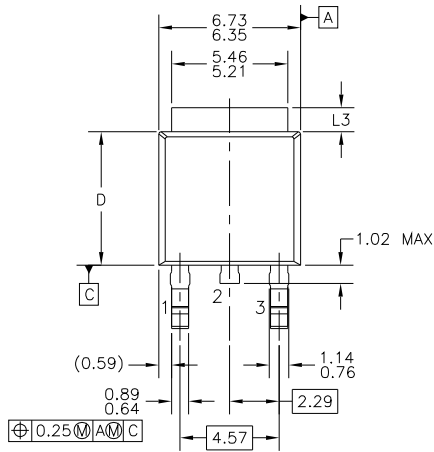

LAND PATTERN RECOMMENDATION

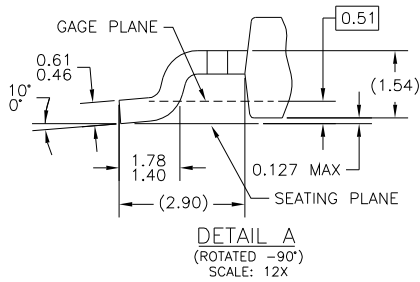
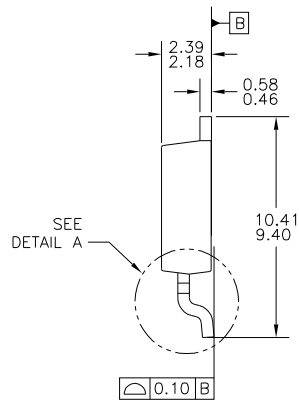
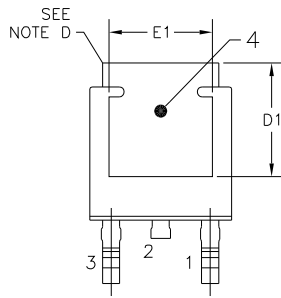

NOTES: UNLESS OTHERWISE SPECIFIED

- A) ALL DIMENSIONS ARE IN MILLIMETERS.
- B) THIS PACKAGE CONFORMS TO JEDEC, TO-252, ISSUE C, VARIATION AA & AB, DATED NOV. 1999.
- C) DIMENSIONING AND TOLERANCING PER ASME Y14.5M-1994.
- D) HEAT SINK TOP EDGE COULD BE IN CHAMFERED CORNERS OR EDGE PROTRUSION.
- E) DIMENSIONS L3,D,E1&D1 TABLE:

	OPTION AA	OPTION AB
L3	0.89-1.27	1.52-2.03
D	5.97-6.22	5.33-5.59
E1	4.32 MIN	3.81 MIN
D1	5.21 MIN	4.57 MIN





- F) PRESENCE OF TRIMMED CENTER LEAD IS OPTIONAL.

Dimensions in Millimeters



TRADEMARKS

The following includes registered and unregistered trademarks and service marks, owned by Fairchild Semiconductor and/or its global subsidiaries, and is not intended to be an exhaustive list of all such trademarks.

- | | | | |
|---|---|--|---|
| 2Cool™ | FPS™ |  | The Power Franchise® |
| AccuPower™ | F-PFS™ | PowerTrench® | the power® |
| Auto-SPM™ | FRFET® | PowerXS™ | franchise |
| AX-CAP™* | Global Power Resource SM | Programmable Active Droop™ | TinyBoost™ |
| BitSic® | Green FPS™ | QFET® | TinyBuck™ |
| Build it Now™ | Green FPS™ e-Series™ | QS™ | TinyCalc™ |
| CorePLUS™ | Gmax™ | Quiet Series™ | TinyLogic® |
| CorePOWER™ | GTO™ | RapidConfigure™ | TINYOPTO™ |
| CROSSVOLT™ | IntelliMAX™ |  | TinyPower™ |
| CTL™ | ISOPLANAR™ | Saving our world, 1mW/W/kW at a time™ | TinyPWM™ |
| Current Transfer Logic™ | Marking Small Speakers Sound Louder and Better™ | SignalWise™ | TinyWire™ |
| DEUXPEED® | MegaBuck™ | SmartMax™ | TranSic® |
| Dual Cool™ | MICROCOUPLER™ | SMART START™ | TriFault Detect™ |
| EcoSPARK® | MicroFET™ | Solutions for Your Success™ | TRUECURRENT®* |
| EfficientMax™ | MicroPak™ | SPM® | µSerDes™ |
| ESBC™ | MicroPak2™ | STEALTH™ |  |
|  | MillerDrive™ | SuperFET® | UHC® |
| Fairchild® | MotionMax™ | SuperSOT™-3 | Ultra FRFET™ |
| Fairchild Semiconductor® | Motion-SPM™ | SuperSOT™-6 | UnifET™ |
| FACT Quiet Series™ | mWSaver™ | SuperSOT™-8 | VCX™ |
| FACT® | OptoHiT™ | SupreMOS® | VisualMax™ |
| FAST® | OPTOLOGIC® | SyncFET™ | VoltagePlus™ |
| FastvCore™ | OPTOPLANAR® | Sync-Lock™ | XS™ |
| FETBench™ | |  | |
| FlashWriter®* | | | |

*Trademarks of System General Corporation, used under license by Fairchild Semiconductor.

DISCLAIMER

FAIRCHILD SEMICONDUCTOR RESERVES THE RIGHT TO MAKE CHANGES WITHOUT FURTHER NOTICE TO ANY PRODUCTS HEREIN TO IMPROVE RELIABILITY, FUNCTION, OR DESIGN. FAIRCHILD DOES NOT ASSUME ANY LIABILITY ARISING OUT OF THE APPLICATION OR USE OF ANY PRODUCT OR CIRCUIT DESCRIBED HEREIN; NEITHER DOES IT CONVEY ANY LICENSE UNDER ITS PATENT RIGHTS, NOR THE RIGHTS OF OTHERS. THESE SPECIFICATIONS DO NOT EXPAND THE TERMS OF FAIRCHILD'S WORLDWIDE TERMS AND CONDITIONS, SPECIFICALLY THE WARRANTY THEREIN, WHICH COVERS THESE PRODUCTS.

LIFE SUPPORT POLICY

FAIRCHILD'S PRODUCTS ARE NOT AUTHORIZED FOR USE AS CRITICAL COMPONENTS IN LIFE SUPPORT DEVICES OR SYSTEMS WITHOUT THE EXPRESS WRITTEN APPROVAL OF FAIRCHILD SEMICONDUCTOR CORPORATION.

As used here in:

- Life support devices or systems are devices or systems which, (a) are intended for surgical implant into the body or (b) support or sustain life, and (c) whose failure to perform when properly used in accordance with instructions for use provided in the labeling, can be reasonably expected to result in a significant injury of the user.
- A critical component in any component of a life support, device, or system whose failure to perform can be reasonably expected to cause the failure of the life support device or system, or to affect its safety or effectiveness.

ANTI-COUNTERFEITING POLICY

Fairchild Semiconductor Corporation's Anti-Counterfeiting Policy. Fairchild's Anti-Counterfeiting Policy is also stated on our external website, www.fairchildsemi.com, under Sales Support. Counterfeiting of semiconductor parts is a growing problem in the industry. All manufactures of semiconductor products are experiencing counterfeiting of their parts. Customers who inadvertently purchase counterfeit parts experience many problems such as loss of brand reputation, substandard performance, failed application, and increased cost of production and manufacturing delays. Fairchild is taking strong measures to protect ourselves and our customers from the proliferation of counterfeit parts. Fairchild strongly encourages customers to purchase Fairchild parts either directly from Fairchild or from Authorized Fairchild Distributors who are listed by country on our web page cited above. Products customers buy either from Fairchild directly or from Authorized Fairchild Distributors are genuine parts, have full traceability, meet Fairchild's quality standards for handling and storage and provide access to Fairchild's full range of up-to-date technical and product information. Fairchild and our Authorized Distributors will stand behind all warranties and will appropriately address and warranty issues that may arise. Fairchild will not provide any warranty coverage or other assistance for parts bought from Unauthorized Sources. Fairchild is committed to combat this global problem and encourage our customers to do their part in stopping this practice by buying direct or from authorized distributors.

PRODUCT STATUS DEFINITIONS

Definition of Terms

Datasheet Identification	Product Status	Definition
Advance Information	Formative / In Design	Datasheet contains the design specifications for product development. Specifications may change in any manner without notice.
Preliminary	First Production	Datasheet contains preliminary data; supplementary data will be published at a later date. Fairchild Semiconductor reserves the right to make changes at any time without notice to improve design.
No Identification Needed	Full Production	Datasheet contains final specifications. Fairchild Semiconductor reserves the right to make changes at any time without notice to improve the design.
Obsolete	Not In Production	Datasheet contains specifications on a product that is discontinued by Fairchild Semiconductor. The datasheet is for reference information only.

Rev. I60