

# FDMA1027P

## Dual P-Channel PowerTrench® MOSFET

### General Description

This device is designed specifically as a single package solution for the battery charge switch in cellular handset and other ultra-portable applications. It features two independent P-Channel MOSFETs with low on-state resistance for minimum conduction losses. When connected in the typical common source configuration, bi-directional current flow is possible.

The MicroFET 2x2 package offers exceptional thermal performance for its physical size and is well suited to linear mode applications.



### Features

- -3.0 A, -20V.  $R_{DS(ON)} = 120\text{ m}\Omega @ V_{GS} = -4.5\text{ V}$   
 $R_{DS(ON)} = 160\text{ m}\Omega @ V_{GS} = -2.5\text{ V}$   
 $R_{DS(ON)} = 240\text{ m}\Omega @ V_{GS} = -1.8\text{ V}$
- Low Profile - 0.8 mm maximum - in the new package MicroFET 2x2 mm
- RoHS Compliant
- Free from halogenated compounds and antimony oxides

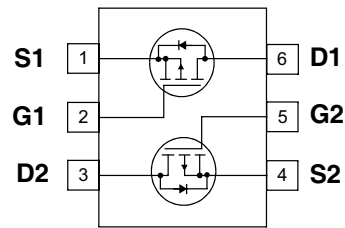
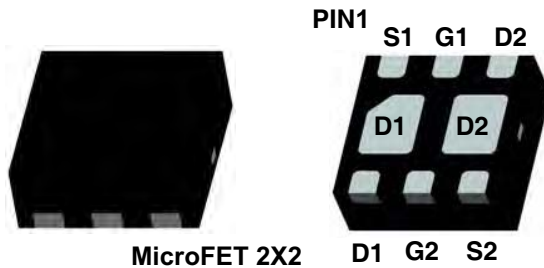

### Absolute Maximum Ratings $T_A = 25^\circ\text{C}$ unless otherwise noted

Symbol	Parameter	Ratings	Units
$V_{DSS}$	MOSFET Drain-Source Voltage	-20	V
$V_{GSS}$	MOSFET Gate-Source Voltage	$\pm 8$	V
$I_D$	Drain Current -Continuous	(Note 1a) -3.0	A
	-Pulsed	-6	
$P_D$	Power dissipation	(Note 1a) 1.4	W
		(Note 1b) 0.7	
		(Note 1c) 1.8	
		(Note 1d) 0.8	
$T_J, T_{STG}$	Operating and Storage Junction Temperature Range	-55 to +150	$^\circ\text{C}$

### Thermal Characteristics

$R_{\theta JA}$	Thermal Resistance for Single Operation, Junction-to-Ambient	(Note 1a)	86	$^\circ\text{C/W}$
$R_{\theta JA}$	Thermal Resistance for Single Operation, Junction-to-Ambient	(Note 1b)	173	
$R_{\theta JA}$	Thermal Resistance for Dual Operation, Junction-to-Ambient	(Note 1c)	69	
$R_{\theta JA}$	Thermal Resistance for Dual Operation, Junction-to-Ambient	(Note 1d)	151	

### Package Marking and Ordering Information

Device Marking	Device	Reel Size	Tape Width	Quantity
027	FDMA1027P	7"	8mm	3000 units

**Electrical Characteristics**  $T_A = 25^\circ\text{C}$  unless otherwise noted

Symbol	Parameter	Test Conditions	Min	Typ	Max	Units
--------	-----------	-----------------	-----	-----	-----	-------

**Off Characteristics**

$BV_{DSS}$	Drain-Source Breakdown Voltage	$V_{GS} = 0V, I_D = -250\mu A$	-20	-	-	V
$\frac{\Delta BV_{DSS}}{\Delta T_J}$	Breakdown Voltage Temperature Coefficient	$I_D = -250\mu A$ , Referenced to $25^\circ\text{C}$	-	-12	-	$\text{mV}/^\circ\text{C}$
$I_{DSS}$	Zero Gate Voltage Drain Current	$V_{DS} = -16V, V_{GS} = 0V$	-	-	-1	$\mu A$
$I_{GSS}$	Gate-Body Leakage,	$V_{GS} = \pm 8V, V_{DS} = 0V$	-	-	$\pm 100$	nA

**On Characteristics** (Note 2)

$V_{GS(th)}$	Gate Threshold Voltage	$V_{DS} = V_{GS}, I_D = -250\mu A$	-0.4	-0.7	-1.3	V
$\frac{\Delta V_{GS(th)}}{\Delta T_J}$	Gate Threshold Voltage Temperature Coefficient	$I_D = -250\mu A$ , Referenced to $25^\circ\text{C}$	-	2	-	$\text{mV}/^\circ\text{C}$
$R_{DS(on)}$	Static Drain-Source On-Resistance	$V_{GS} = -4.5V, I_D = -3.0A$	-	90	120	m $\Omega$
		$V_{GS} = -2.5V, I_D = -2.5A$	-	120	160	
		$V_{GS} = -1.8V, I_D = -1.0A$	-	172	240	
		$V_{GS} = -4.5V, I_D = -3.0A$ , $T_J = 125^\circ\text{C}$	-	118	160	
$I_{D(on)}$	On-State Drain Current	$V_{GS} = -4.5V, V_{DS} = -5V$	-20	-	-	A
$g_{FS}$	Forward Transconductance	$V_{DS} = -5V, I_D = -3.0A$	-	7	-	S

**Dynamic Characteristics**

$C_{iss}$	Input Capacitance	$V_{DS} = -10V, V_{GS} = 0V$ , $f = 1.0\text{MHz}$	-	435	-	pF
$C_{oss}$	Output Capacitance		-	80	-	pF
$C_{rss}$	Reverse Transfer Capacitance		-	45	-	pF

**Switching Characteristics** (Note 2)

$t_{d(on)}$	Turn-On Delay Time	$V_{DD} = -10V, I_D = -1A$ , $V_{GS} = -4.5V, R_{GEN} = 6\Omega$	-	9	18	ns
$t_r$	Turn-On Rise Time		-	11	19	ns
$t_{d(off)}$	Turn-Off Delay Time		-	15	27	ns
$t_f$	Turn-Off Fall Time		-	6	12	ns
$Q_g$	Total Gate Charge	$V_{DS} = -10V, I_D = -3.0A$ , $V_{GS} = -4.5V$	-	4	6	nC
$Q_{gs}$	Gate-Source Charge		-	0.8	-	nC
$Q_{gd}$	Gate-Drain Charge		-	0.9	-	nC

**Drain-Source Diode Characteristics and Maximum Ratings**

$I_S$	Maximum Continuous Drain-Source Diode Forward Current	-	-	-1.1	A	
$V_{SD}$	Drain-Source Diode Forward Voltage	$V_{GS} = 0V, I_S = -1.1A$ (Note 2)	-	-0.8	-1.2	V
$t_{rr}$	Diode Reverse Recovery Time	$I_F = -3.0A, dI_F/dt = 100A/\mu s$	-	17	-	ns
$Q_{rr}$	Diode Reverse Recovery Charge		-	6	-	nC

## Electrical Characteristics $T_A = 25^\circ\text{C}$ unless otherwise noted

### Notes:

1:  $R_{\theta JA}$  is determined with the device mounted on a 1 in<sup>2</sup> oz. copper pad on a 1.5 x 1.5 in. board of FR-4 material.  $R_{\theta JC}$  is guaranteed by design while  $R_{\theta JA}$  is determined by the user's board design.

- (a)  $R_{\theta JA} = 86^\circ\text{C/W}$  when mounted on a 1 in<sup>2</sup> pad of 2 oz copper, 1.5" x 1.5" x 0.062" thick PCB. For single operation.
- (b)  $R_{\theta JA} = 173^\circ\text{C/W}$  when mounted on a minimum pad of 2 oz copper. For single operation.
- (c)  $R_{\theta JA} = 69^\circ\text{C/W}$  when mounted on a 1 in<sup>2</sup> pad of 2 oz copper, 1.5" x 1.5" x 0.062" thick PCB, For dual operation, configured in parallel.
- (d)  $R_{\theta JA} = 151^\circ\text{C/W}$  when mounted on a minimum pad of 2 oz copper. For dual operation, configured in parallel.



a)  $86^\circ\text{C/W}$  when mounted on a 1 in<sup>2</sup> pad of 2 oz copper.

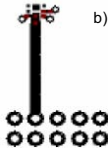

b)  $173^\circ\text{C/W}$  when mounted on a minimum pad of 2 oz copper.



c)  $69^\circ\text{C/W}$  when mounted on a 1 in<sup>2</sup> pad of 2 oz copper.

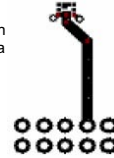

d)  $151^\circ\text{C/W}$  when mounted on a minimum pad of 2 oz copper.

2: Pulse Test : Pulse Width < 300us, Duty Cycle < 2.0%

## Typical Characteristics

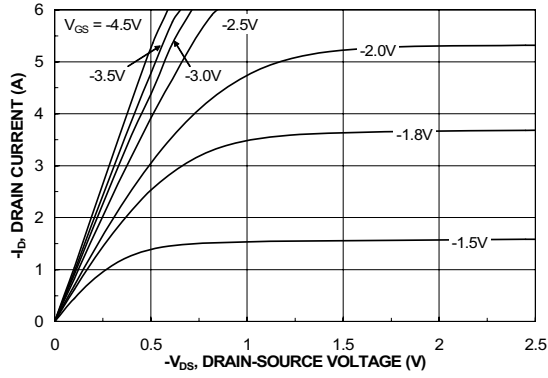

Figure 1. On-Region Characteristics

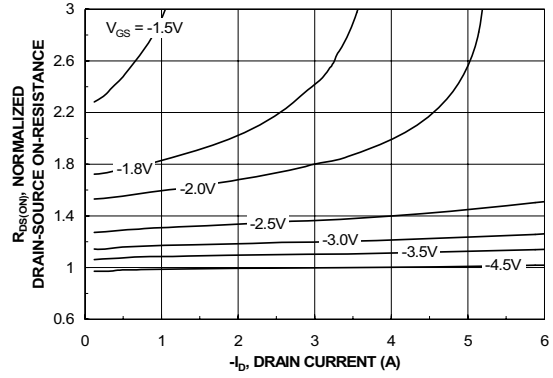

Figure 2. On-Resistance Variation with Drain Current and Gate Voltage

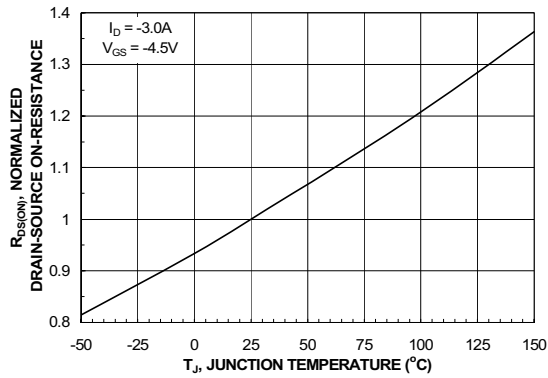

Figure 3. On-Resistance Variation with Temperature

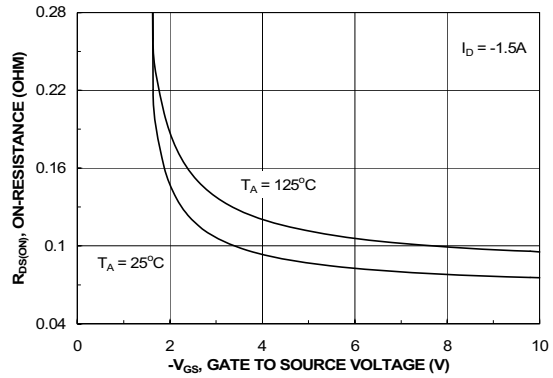

Figure 4. On-Resistance Variation with Gate-to-Source Voltage

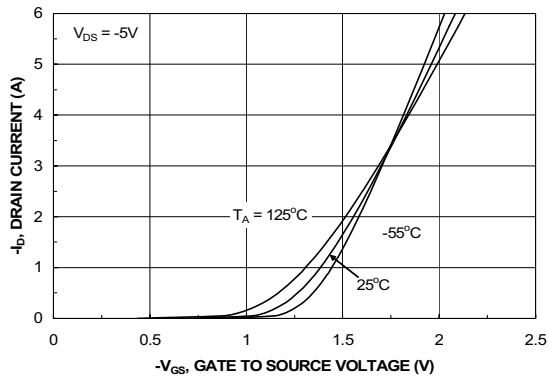

Figure 5. Transfer Characteristics

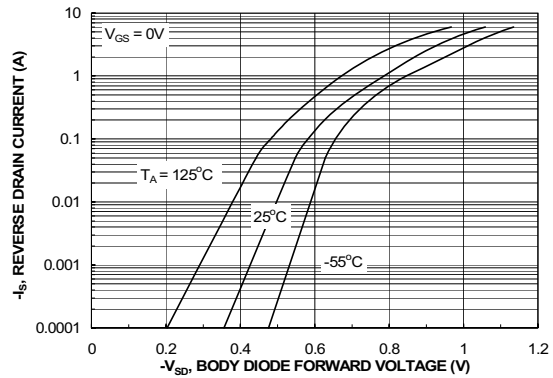

Figure 6. Body Diode Forward Voltage Variation with Source Current and Temperature

### Typical Characteristics

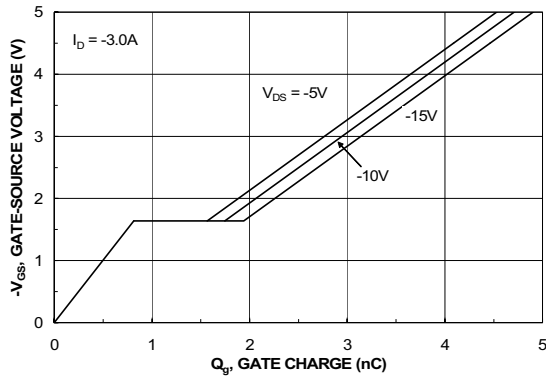

Figure 7. Gate Charge Characteristics

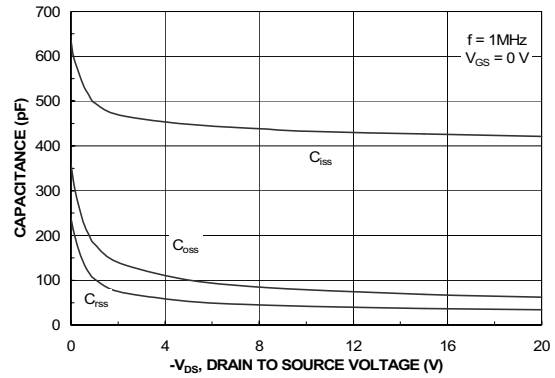

Figure 8. Capacitance Characteristics

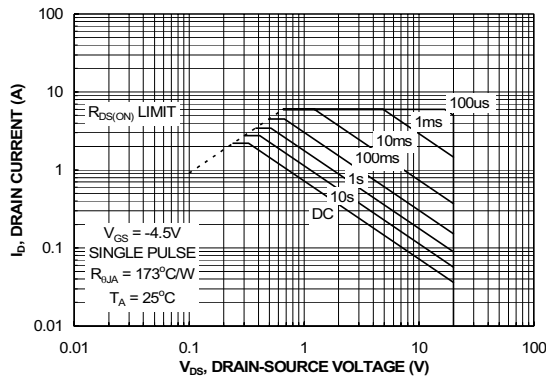

Figure 9. Maximum Safe Operation Area

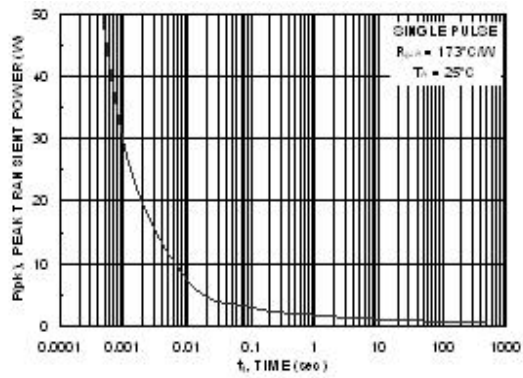

Figure 10. Single Pulse Maximum Power Dissipation

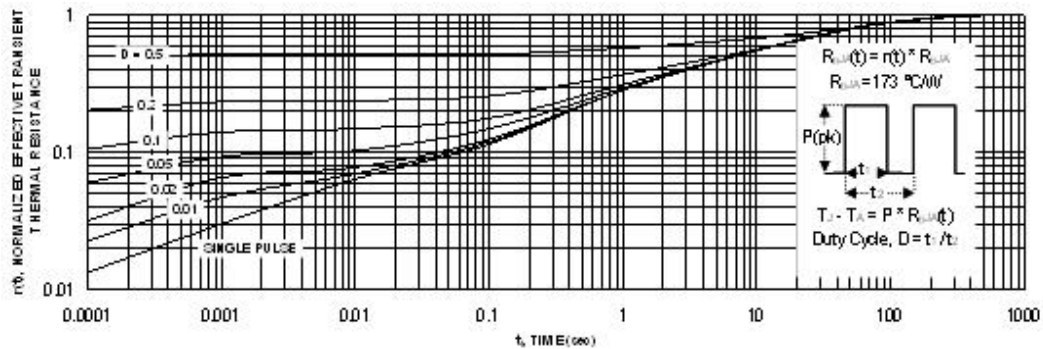
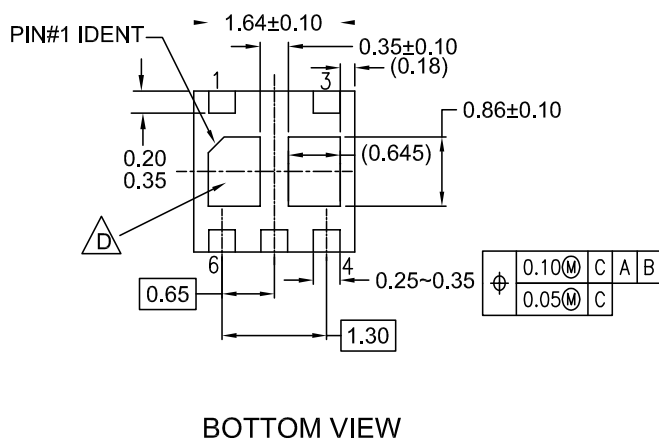
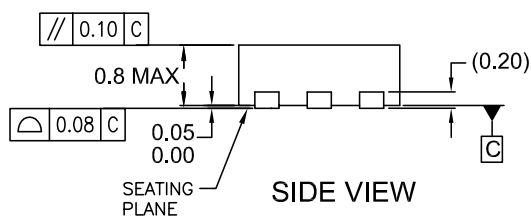
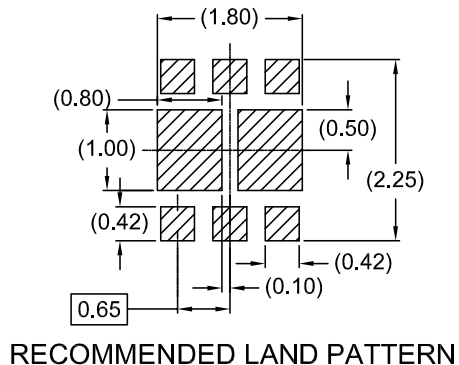
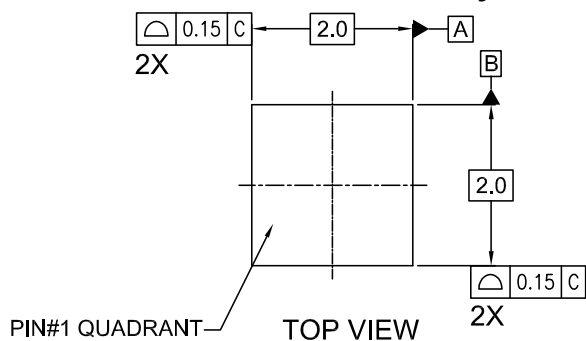

Figure 11. Transient Thermal Response Curve

Thermal characterization performed using the conditions described in Note 1b. Transient thermal response will change depending on the circuit board design.

### Dimensional Outline and Pad Layout



### NOTES:

- A. CONFORMS TO JEDEC REGISTRATION MO-229, VARIATION VCCC EXCEPT AS NOTED.
- B. DIMENSIONS ARE IN MILLIMETERS.
- C. DIMENSIONS AND TOLERANCES PER ASME Y14.5M, 1994
- D. NON-JEDEC DUAL DAP

MLP06JrevC





**TRADEMARKS**

The following includes registered and unregistered trademarks and service marks, owned by Fairchild Semiconductor and/or its global subsidiaries, and is not intended to be an exhaustive list of all such trademarks.

AccuPower™  
Auto-SPM™  
Build it Now™  
CorePLUS™  
CorePOWER™  
CROSSVOLT™  
CTL™  
Current Transfer Logic™  
DEUXPEED®  
Dual Cool™  
EcoSPARK®  
EfficientMax™  
ESBC™  
**F**®  
Fairchild®  
Fairchild Semiconductor®  
FACT Quiet Series™  
FACT®  
FAST®  
FastvCore™  
FETBench™  
FlashWriter® \*  
FPS™

F-PFS™  
FRFET®  
Global Power Resource<sup>SM</sup>  
Green FPS™  
Green FPS™ e-Series™  
Gmax™  
GTO™  
IntelliMAX™  
ISOPLANAR™  
MegaBuck™  
MICROCOUPLER™  
MicroFET™  
MicroPak™  
MicroPak2™  
MillerDrive™  
MotionMax™  
Motion-SPM™  
OptiHiT™  
OPTOLOGIC®  
OPTOPLANAR®  
®  
PDP SPM™

Power-SPM™  
PowerTrench®  
PowerXS™  
Programmable Active Droop™  
QFET®  
QS™  
Quiet Series™  
RapidConfigure™  
™  
Saving our world, 1mW/W/kW at a time™  
SignalWise™  
SmartMax™  
SMART START™  
SPM®  
STEALTH™  
SuperFET™  
SuperSOT™-3  
SuperSOT™-6  
SuperSOT™-8  
SupreMOS™  
SyncFET™  
Sync-Lock™

**SYSTEM GENERAL**®  
The Power Franchise®  
the **power**®  
franchise  
TinyBoost™  
TinyBuck™  
TinyCalc™  
TinyLogic®  
TINYOPTO™  
TinyPower™  
TinyPWM™  
TinyWire™  
TriFault Detect™  
TRUECURRENT™\*  
µSerDes™  
 SerDes®  
UHC®  
Ultra FRFET™  
UniFET™  
VCX™  
VisualMax™  
XS™

\*Trademarks of System General Corporation, used under license by Fairchild Semiconductor.

**DISCLAIMER**

FAIRCHILD SEMICONDUCTOR RESERVES THE RIGHT TO MAKE CHANGES WITHOUT FURTHER NOTICE TO ANY PRODUCTS HEREIN TO IMPROVE RELIABILITY, FUNCTION, OR DESIGN. FAIRCHILD DOES NOT ASSUME ANY LIABILITY ARISING OUT OF THE APPLICATION OR USE OF ANY PRODUCT OR CIRCUIT DESCRIBED HEREIN; NEITHER DOES IT CONVEY ANY LICENSE UNDER ITS PATENT RIGHTS, NOR THE RIGHTS OF OTHERS. THESE SPECIFICATIONS DO NOT EXPAND THE TERMS OF FAIRCHILD'S WORLDWIDE TERMS AND CONDITIONS, SPECIFICALLY THE WARRANTY THEREIN, WHICH COVERS THESE PRODUCTS.

**LIFE SUPPORT POLICY**

FAIRCHILD'S PRODUCTS ARE NOT AUTHORIZED FOR USE AS CRITICAL COMPONENTS IN LIFE SUPPORT DEVICES OR SYSTEMS WITHOUT THE EXPRESS WRITTEN APPROVAL OF FAIRCHILD SEMICONDUCTOR CORPORATION.

As used here in:

- Life support devices or systems are devices or systems which, (a) are intended for surgical implant into the body or (b) support or sustain life, and (c) whose failure to perform when properly used in accordance with instructions for use provided in the labeling, can be reasonably expected to result in a significant injury of the user.
- A critical component in any component of a life support, device, or system whose failure to perform can be reasonably expected to cause the failure of the life support device or system, or to affect its safety or effectiveness.

**ANTI-COUNTERFEITING POLICY**

Fairchild Semiconductor Corporation's Anti-Counterfeiting Policy. Fairchild's Anti-Counterfeiting Policy is also stated on our external website, [www.Fairchildsemi.com](http://www.Fairchildsemi.com), under Sales Support.

Counterfeiting of semiconductor parts is a growing problem in the industry. All manufactures of semiconductor products are experiencing counterfeiting of their parts. Customers who inadvertently purchase counterfeit parts experience many problems such as loss of brand reputation, substandard performance, failed application, and increased cost of production and manufacturing delays. Fairchild is taking strong measures to protect ourselves and our customers from the proliferation of counterfeit parts. Fairchild strongly encourages customers to purchase Fairchild parts either directly from Fairchild or from Authorized Fairchild Distributors who are listed by country on our web page cited above. Products customers buy either from Fairchild directly or from Authorized Fairchild Distributors are genuine parts, have full traceability, meet Fairchild's quality standards for handling and storage and provide access to Fairchild's full range of up-to-date technical and product information. Fairchild and our Authorized Distributors will stand behind all warranties and will appropriately address and warranty issues that may arise. Fairchild will not provide any warranty coverage or other assistance for parts bought from Unauthorized Sources. Fairchild is committed to combat this global problem and encourage our customers to do their part in stopping this practice by buying direct or from authorized distributors.

**PRODUCT STATUS DEFINITIONS**  
Definition of Terms

Datasheet Identification	Product Status	Definition
Advance Information	Formative / In Design	Datasheet contains the design specifications for product development. Specifications may change in any manner without notice.
Preliminary	First Production	Datasheet contains preliminary data; supplementary data will be published at a later date. Fairchild Semiconductor reserves the right to make changes at any time without notice to improve design.
No Identification Needed	Full Production	Datasheet contains final specifications. Fairchild Semiconductor reserves the right to make changes at any time without notice to improve the design.
Obsolete	Not In Production	Datasheet contains specifications on a product that is discontinued by Fairchild Semiconductor. The datasheet is for reference information only.