

FDP120N10

N-Channel PowerTrench® MOSFET

100V, 74A, 12mΩ

Features

- $R_{DS(on)} = 9.7m\Omega$ (Typ.) @ $V_{GS} = 10V, I_D = 74A$
- Fast Switching Speed
- Low Gate Charge
- High Performance Trench Technology for Extremely Low $R_{DS(on)}$
- High Power and Current Handling Capability
- RoHS Compliant

Description

This N-Channel MOSFET is produced using Fairchild Semiconductor's advanced PowerTrench process that has been especially tailored to minimize the on-state resistance and yet maintain superior switching performance.

Application

- DC to DC Convertors / Synchronous Rectification

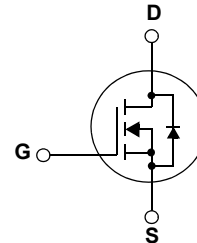
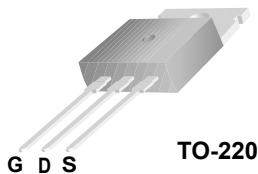

MOSFET Maximum Ratings $T_C = 25^\circ\text{C}$ unless otherwise noted

| Symbol | Parameter | Ratings | Units |
|----------------|--|--|------------------|
| V_{DSS} | Drain to Source Voltage | 100 | V |
| V_{GSS} | Gate to Source Voltage | ± 20 | V |
| I_D | Drain Current | - Continuous ($T_C = 25^\circ\text{C}$) | 74 |
| | | - Continuous ($T_C = 100^\circ\text{C}$) | 52 |
| I_{DM} | Drain Current | - Pulsed (Note 1) | 296 |
| E_{AS} | Single Pulsed Avalanche Energy | (Note 2) | 198 |
| dv/dt | Peak Diode Recovery dv/dt | (Note 3) | 5.8 |
| P_D | Power Dissipation | ($T_C = 25^\circ\text{C}$) | 170 |
| | | - Derate above 25°C | 1.14 |
| T_J, T_{STG} | Operating and Storage Temperature Range | -55 to +175 | $^\circ\text{C}$ |
| T_L | Maximum Lead Temperature for Soldering Purpose, 1/8" from Case for 5 Seconds | 300 | $^\circ\text{C}$ |

Thermal Characteristics

| Symbol | Parameter | Ratings | Units |
|-----------------|---|---------|---------------------------|
| $R_{\theta JC}$ | Thermal Resistance, Junction to Case | 0.88 | $^\circ\text{C}/\text{W}$ |
| $R_{\theta CS}$ | Thermal Resistance, Case to Sink, Typ. | 0.5 | |
| $R_{\theta JA}$ | Thermal Resistance, Junction to Ambient | 62.5 | |

Package Marking and Ordering Information

| Device Marking | Device | Package | Reel Size | Tape Width | Quantity |
|----------------|-----------|---------|-----------|------------|----------|
| FDP120N10 | FDP120N10 | TO-220 | - | - | 50 |

Electrical Characteristics $T_C = 25^\circ\text{C}$ unless otherwise noted

| Symbol | Parameter | Test Conditions | Min. | Typ. | Max. | Units |
|--------|-----------|-----------------|------|------|------|-------|
|--------|-----------|-----------------|------|------|------|-------|

Off Characteristics

| | | | | | | |
|--------------------------------------|---|---|-----|-----|-----------|---------------------------|
| BV_{DSS} | Drain to Source Breakdown Voltage | $I_D = 250\mu\text{A}, V_{GS} = 0\text{V}, T_C = 25^\circ\text{C}$ | 100 | - | - | V |
| $\frac{\Delta BV_{DSS}}{\Delta T_J}$ | Breakdown Voltage Temperature Coefficient | $I_D = 250\mu\text{A}$, Referenced to 25°C | - | 0.1 | - | $\text{V}/^\circ\text{C}$ |
| I_{DSS} | Zero Gate Voltage Drain Current | $V_{DS} = 100\text{V}, V_{GS} = 0\text{V}$ $V_{DS} = 100\text{V}, V_{GS} = 0\text{V}, T_C = 150^\circ\text{C}$ | - | - | 1 500 | μA |
| I_{GSS} | Gate to Body Leakage Current | $V_{GS} = \pm 20\text{V}, V_{DS} = 0\text{V}$ | - | - | ± 100 | nA |

On Characteristics

| | | | | | | |
|--------------|--------------------------------------|--|-----|-----|-----|------------------|
| $V_{GS(th)}$ | Gate Threshold Voltage | $V_{GS} = V_{DS}, I_D = 250\mu\text{A}$ | 2.5 | - | 4.5 | V |
| $R_{DS(on)}$ | Static Drain to Source On Resistance | $V_{GS} = 10\text{V}, I_D = 74\text{A}$ | - | 9.7 | 12 | $\text{m}\Omega$ |
| g_{FS} | Forward Transconductance | $V_{DS} = 10\text{V}, I_D = 74\text{A}$ (Note 4) | - | 105 | - | S |

Dynamic Characteristics

| | | | | | | |
|--------------|-------------------------------|--|---|------|------|----|
| C_{iss} | Input Capacitance | $V_{DS} = 25\text{V}, V_{GS} = 0\text{V}$ $f = 1\text{MHz}$ | - | 4215 | 5605 | pF |
| C_{oss} | Output Capacitance | | - | 405 | 540 | pF |
| C_{rSS} | Reverse Transfer Capacitance | | - | 170 | 255 | pF |
| $Q_{g(tot)}$ | Total Gate Charge at 10V | $V_{DS} = 80\text{V}, I_D = 74\text{A}$ $V_{GS} = 10\text{V}$ (Note 4, 5) | - | 66 | 86 | nC |
| Q_{gs} | Gate to Source Gate Charge | | - | 26 | - | nC |
| Q_{gd} | Gate to Drain "Miller" Charge | | - | 20 | - | nC |

Switching Characteristics

| | | | | | | |
|--------------|---------------------|---|---|-----|-----|----|
| $t_{d(on)}$ | Turn-On Delay Time | $V_{DD} = 50\text{V}, I_D = 74\text{A}$ $V_{GS} = 10\text{V}, R_{GEN} = 4.7\Omega$ (Note 4, 5) | - | 27 | 64 | ns |
| t_r | Turn-On Rise Time | | - | 105 | 220 | ns |
| $t_{d(off)}$ | Turn-Off Delay Time | | - | 39 | 88 | ns |
| t_f | Turn-Off Fall Time | | - | 15 | 40 | ns |

Drain-Source Diode Characteristics

| | | | | | | |
|----------|--|---|---|-----|-----|----|
| I_S | Maximum Continuous Drain to Source Diode Forward Current | - | - | 74 | A | |
| I_{SM} | Maximum Pulsed Drain to Source Diode Forward Current | - | - | 296 | A | |
| V_{SD} | Drain to Source Diode Forward Voltage | $V_{GS} = 0\text{V}, I_{SD} = 74\text{A}$ | - | - | 1.3 | V |
| t_{rr} | Reverse Recovery Time | $V_{GS} = 0\text{V}, I_{SD} = 74\text{A}$ $di_F/dt = 100\text{A}/\mu\text{s}$ (Note 4) | - | 44 | - | ns |
| Q_{rr} | Reverse Recovery Charge | | - | 67 | - | nC |

Notes:

1. Repetitive Rating: Pulse width limited by maximum junction temperature
2. $L = 0.11\text{mH}, I_{AS} = 60\text{A}, V_{DD} = 50\text{V}, R_G = 25\Omega$, Starting $T_J = 25^\circ\text{C}$
3. $I_{SD} \leq 74\text{A}, di/dt \leq 200\text{A}/\mu\text{s}, V_{DD} \leq BV_{DSS}$, Starting $T_J = 25^\circ\text{C}$
4. Pulse Test: Pulse width $\leq 300\mu\text{s}$, Duty Cycle $\leq 2\%$
5. Essentially Independent of Operating Temperature Typical Characteristics

Typical Performance Characteristics

Figure 1. On-Region Characteristics

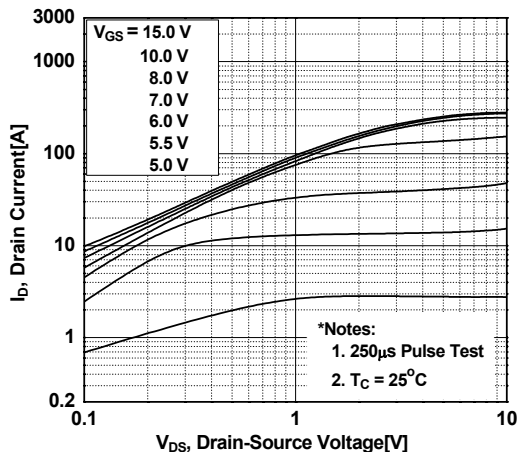

Figure 2. Transfer Characteristics

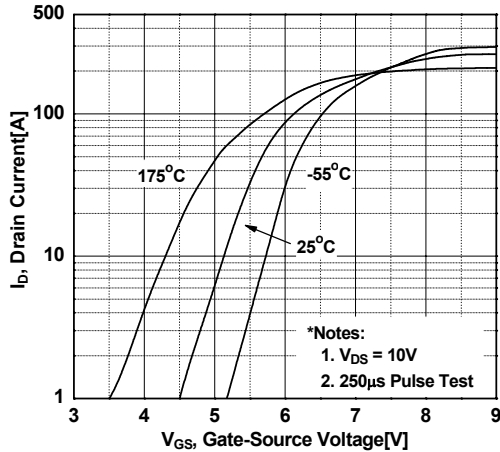

Figure 3. On-Resistance Variation vs. Drain Current and Gate Voltage

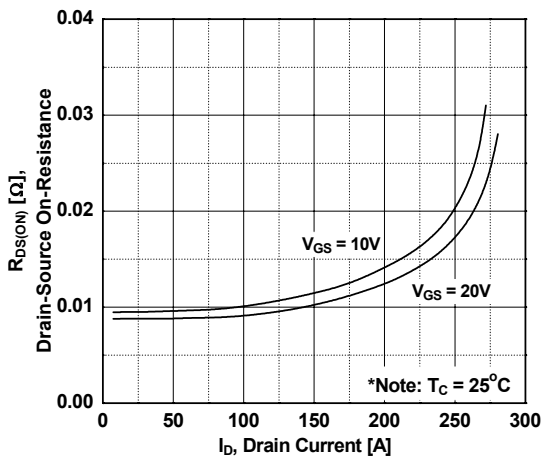

Figure 4. Body Diode Forward Voltage Variation vs. Source Current and Temperature

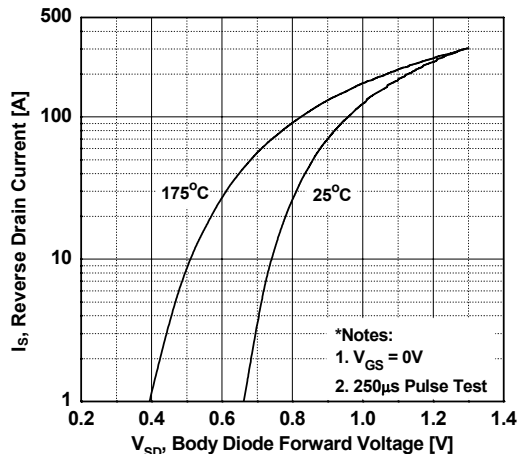

Figure 5. Capacitance Characteristics

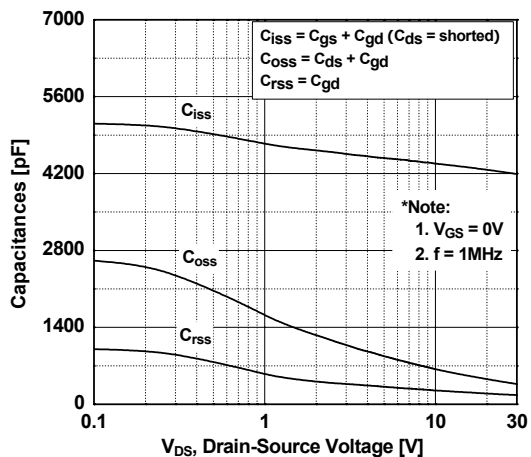
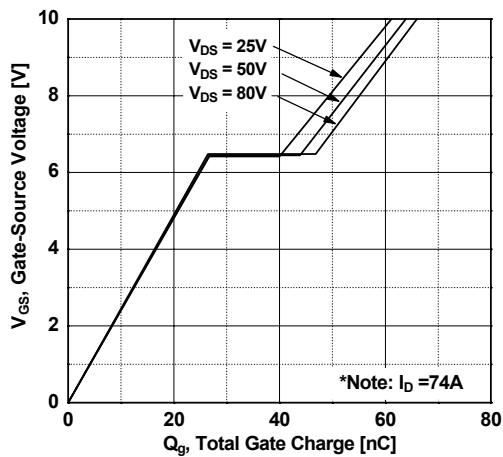

Figure 6. Gate Charge Characteristics



Typical Performance Characteristics (Continued)

Figure 7. Breakdown Voltage Variation vs. Temperature

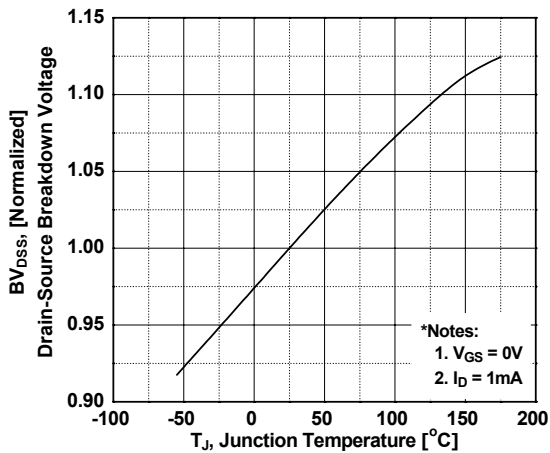

Figure 8. On-Resistance Variation vs. Temperature

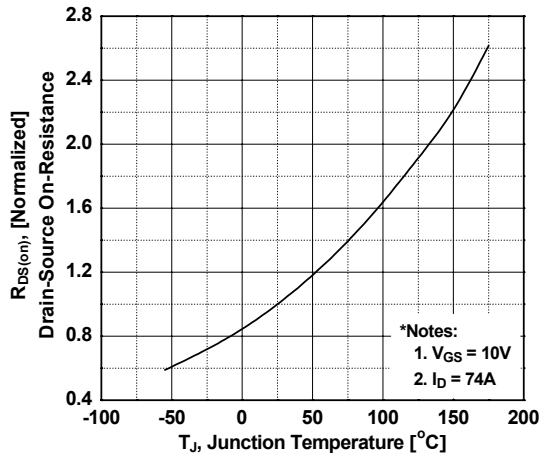

Figure 9. Maximum Safe Operating Area

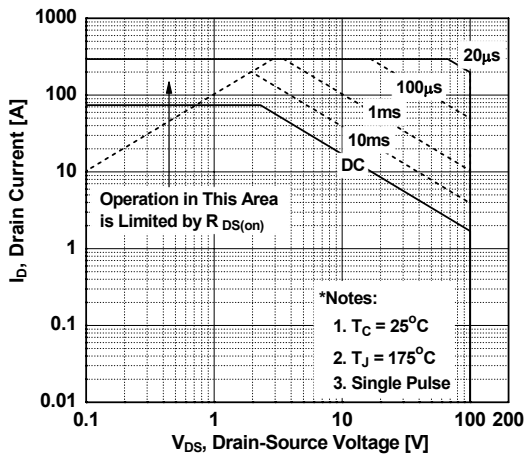

Figure 10. Maximum Drain Current vs. Case Temperature

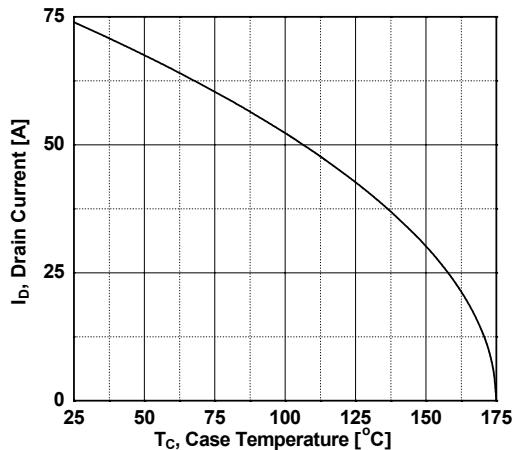
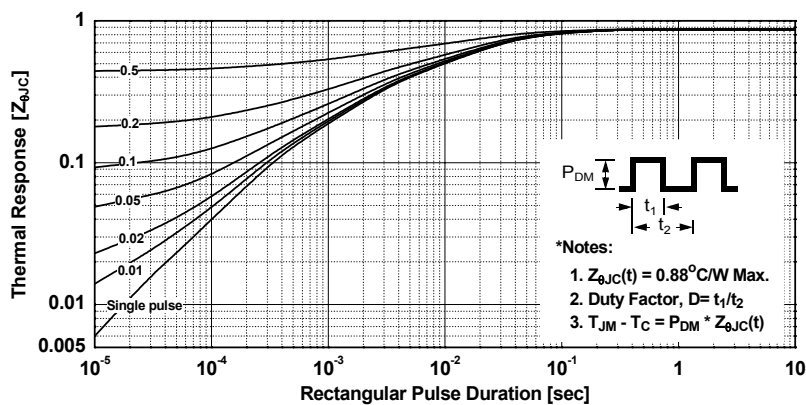
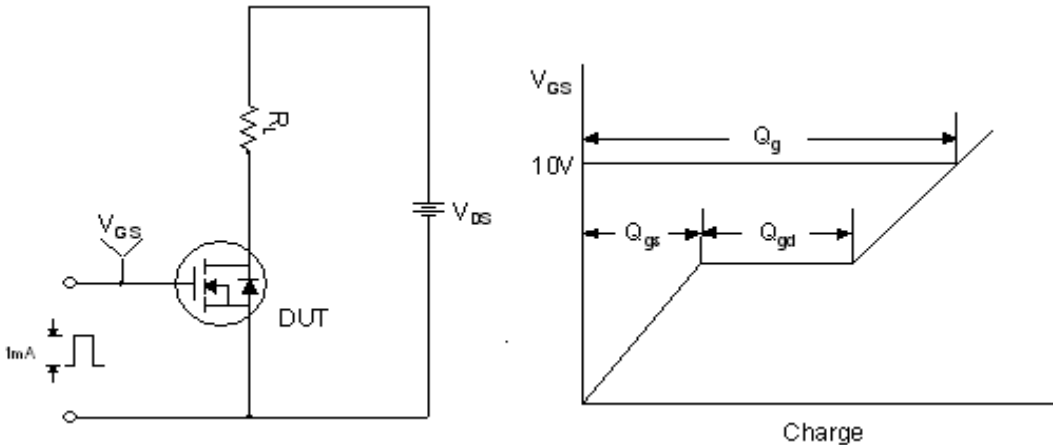

Figure 11. Transient Thermal Response Curve



Gate Charge Test Circuit & Waveform



Resistive Switching Test Circuit & Waveforms

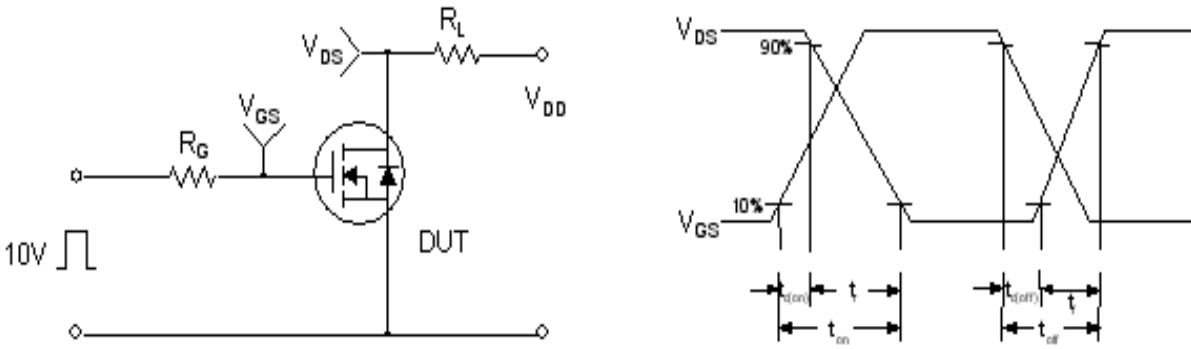

Unclamped Inductive Switching Test Circuit & Waveforms

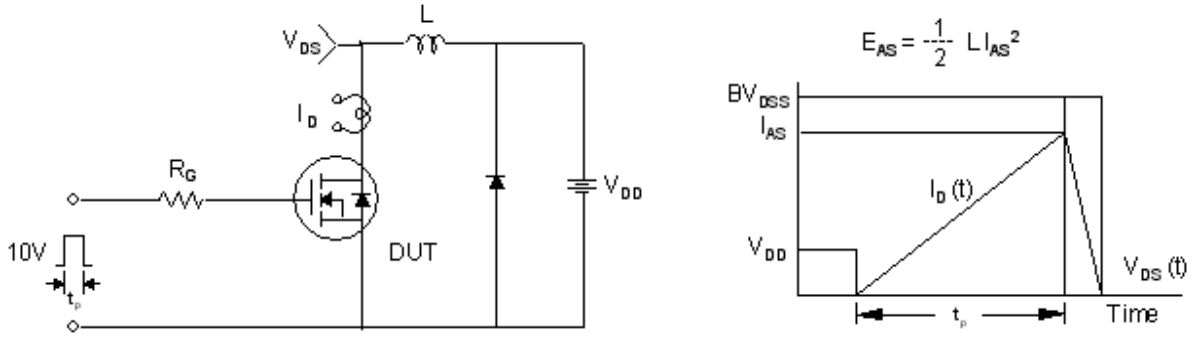

Peak Diode Recovery dv/dt Test Circuit & Waveforms

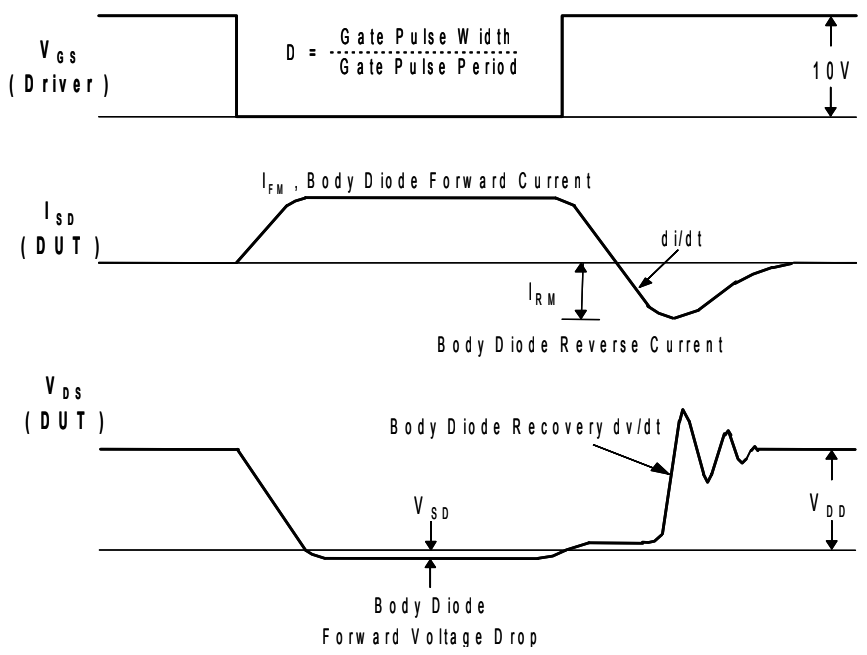
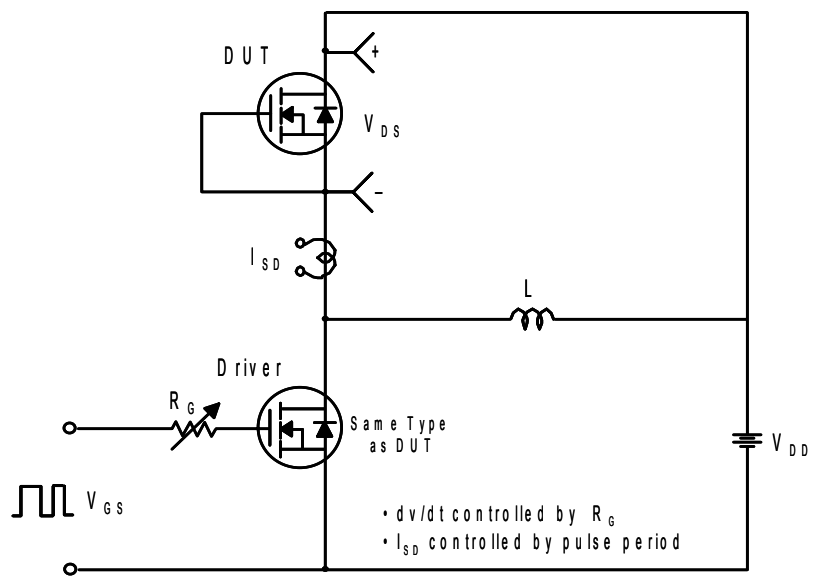

Mechanical Dimensions

TO-220

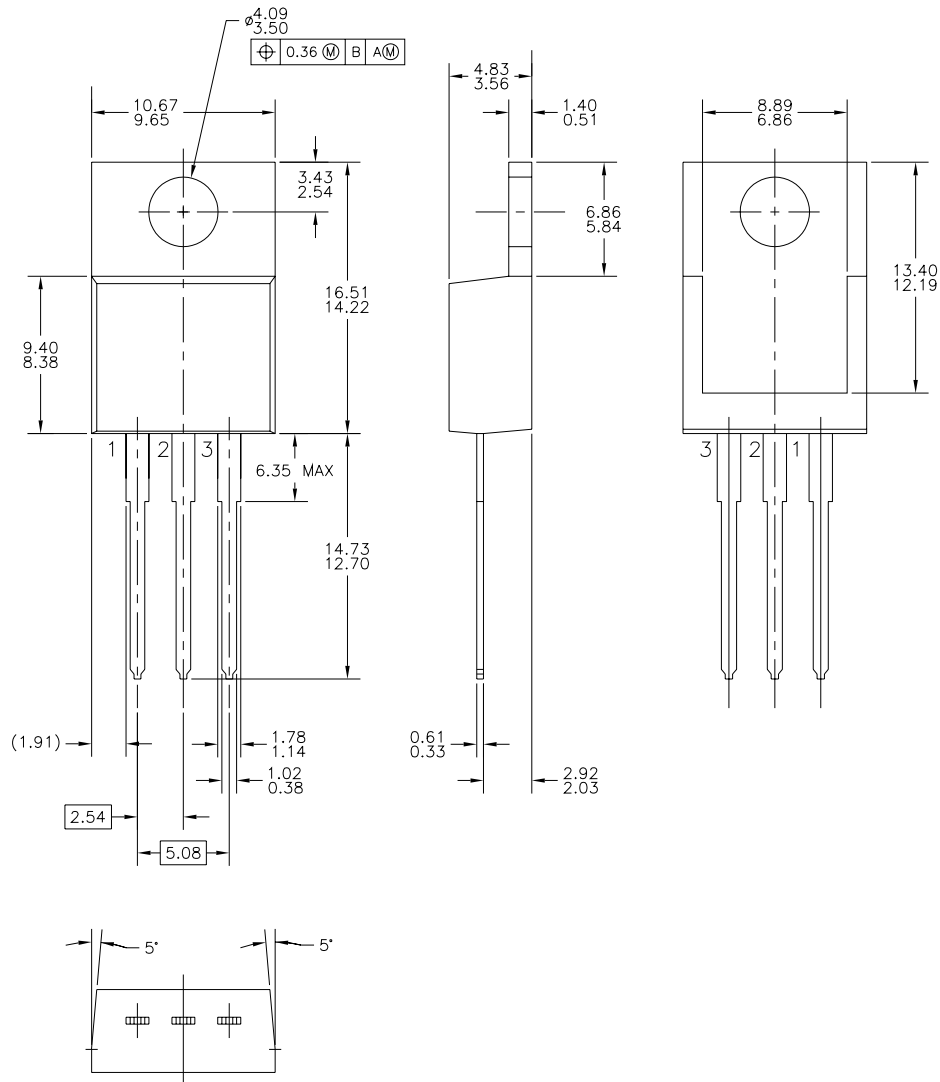







Dimensions in Millimeters

FDP120N10 N-Channel PowerTrench® MOSFET



TRADEMARKS

The following includes registered and unregistered trademarks and service marks, owned by Fairchild Semiconductor and/or its global subsidiaries, and is not intended to be an exhaustive list of all such trademarks.

- | | | | |
|--|---|--|---|
| Auto-SPM™ | F-PFS™ | PowerTrench® | The Power Franchise® |
| Build it Now™ | FRFET® | PowerXS™ | the power™ franchise |
| CorePLUS™ | Global Power Resource SM | Programmable Active Droop™ | TinyBoost™ |
| CorePOWER™ | Green FPS™ | QFET® | TinyBuck™ |
| CROSSVOL™ | Green FPS™ e-Series™ | QS™ | TinyLogic® |
| CTL™ | Gmax™ | Quiet Series™ | TINYOPTO™ |
| Current Transfer Logic™ | GTO™ | RapidConfigure™ | TinyPower™ |
| EcoSPARK® | IntelliMAX™ |  ™ | TinyPWM™ |
| EfficientMax™ | ISOPLANAR™ | Saving our world, 1mW/W/kW at a time™ | TinyWire™ |
| EZSWITCH™* | MegaBuck™ | SmartMax™ | TriFault Detect™ |
|  ™* | MICROCOUPLER™ | SMART START™ | TRUECURRENT™* |
|  ™ | MicroFET™ | SPM® | µSerDes™ |
| Fairchild® | MicroPak™ | STEALTH™ |  ™ |
| Fairchild Semiconductor® | MillerDrive™ | SuperFET™ | UHC® |
| FACT Quiet Series™ | MotionMax™ | SuperSOT™-3 | Ultra FRFET™ |
| FACT® | Motion-SPM™ | SuperSOT™-6 | UniFET™ |
| FAST® | OPTOLOGIC® | SuperSOT™-8 | VCX™ |
| FastvCore™ | OPTOPLANAR® | SupreMOS™ | VisualMax™ |
| FETBench™ |  ™ | SyncFET™ | XS™ |
| FlashWriter®* | PDP SPM™ | Sync-Lock™ | |
| FPS™ | Power-SPM™ |  ™* | |

* Trademarks of System General Corporation, used under license by Fairchild Semiconductor.

DISCLAIMER

FAIRCHILD SEMICONDUCTOR RESERVES THE RIGHT TO MAKE CHANGES WITHOUT FURTHER NOTICE TO ANY PRODUCTS HEREIN TO IMPROVE RELIABILITY, FUNCTION, OR DESIGN. FAIRCHILD DOES NOT ASSUME ANY LIABILITY ARISING OUT OF THE APPLICATION OR USE OF ANY PRODUCT OR CIRCUIT DESCRIBED HEREIN; NEITHER DOES IT CONVEY ANY LICENSE UNDER ITS PATENT RIGHTS, NOR THE RIGHTS OF OTHERS. THESE SPECIFICATIONS DO NOT EXPAND THE TERMS OF FAIRCHILD'S WORLDWIDE TERMS AND CONDITIONS, SPECIFICALLY THE WARRANTY THEREIN, WHICH COVERS THESE PRODUCTS.

LIFE SUPPORT POLICY

FAIRCHILD'S PRODUCTS ARE NOT AUTHORIZED FOR USE AS CRITICAL COMPONENTS IN LIFE SUPPORT DEVICES OR SYSTEMS WITHOUT THE EXPRESS WRITTEN APPROVAL OF FAIRCHILD SEMICONDUCTOR CORPORATION.

As used herein:

1. Life support devices or systems are devices or systems which, (a) are intended for surgical implant into the body or (b) support or sustain life, and (c) whose failure to perform when properly used in accordance with instructions for use provided in the labeling, can be reasonably expected to result in a significant injury of the user.
2. A critical component in any component of a life support, device, or system whose failure to perform can be reasonably expected to cause the failure of the life support device or system, or to affect its safety or effectiveness.

ANTI-COUNTERFEITING POLICY

Fairchild Semiconductor Corporation's Anti-Counterfeiting Policy. Fairchild's Anti-Counterfeiting Policy is also stated on our external website, www.fairchildsemi.com, under Sales Support.

Counterfeiting of semiconductor parts is a growing problem in the industry. All manufacturers of semiconductor products are experiencing counterfeiting of their parts. Customers who inadvertently purchase counterfeit parts experience many problems such as loss of brand reputation, substandard performance, failed applications, and increased cost of production and manufacturing delays. Fairchild is taking strong measures to protect ourselves and our customers from the proliferation of counterfeit parts. Fairchild strongly encourages customers to purchase Fairchild parts either directly from Fairchild or from Authorized Fairchild Distributors who are listed by country on our web page cited above. Products customers buy either from Fairchild directly or from Authorized Fairchild Distributors are genuine parts, have full traceability, meet Fairchild's quality standards for handling and storage and provide access to Fairchild's full range of up-to-date technical and product information. Fairchild and our Authorized Distributors will stand behind all warranties and will appropriately address any warranty issues that may arise. Fairchild will not provide any warranty coverage or other assistance for parts bought from Unauthorized Sources. Fairchild is committed to combat this global problem and encourage our customers to do their part in stopping this practice by buying direct or from authorized distributors.

PRODUCT STATUS DEFINITIONS

Definition of Terms

| Datasheet Identification | Product Status | Definition |
|--------------------------|-----------------------|---|
| Advance Information | Formative / In Design | Datasheet contains the design specifications for product development. Specifications may change in any manner without notice. |
| Preliminary | First Production | Datasheet contains preliminary data; supplementary data will be published at a later date. Fairchild Semiconductor reserves the right to make changes at any time without notice to improve design. |
| No Identification Needed | Full Production | Datasheet contains final specifications. Fairchild Semiconductor reserves the right to make changes at any time without notice to improve the design. |
| Obsolete | Not In Production | Datasheet contains specifications on a product that is discontinued by Fairchild Semiconductor. The datasheet is for reference information only. |