

FDPF045N10A

N-Channel PowerTrench® MOSFET

100V, 67A, 4.5mΩ

Features

- $R_{DS(on)} = 3.7m\Omega$ (Typ.) @ $V_{GS} = 10V, I_D = 67A$
- Fast Switching Speed
- Low Gate Charge
- High Performance Trench Technology for Extremely Low $R_{DS(on)}$
- High Power and Current Handling Capability
- RoHS Compliant

Description

This N-Channel MOSFET is produced using Fairchild Semiconductor's advance PowerTrench process that has been especially tailored to minimize the on-state resistance and yet maintain superior switching performance.

Application

- DC to DC Converters
- Synchronous Rectification for Telecommunication PSU
- Battery Charger
- AC motor drives and Uninterruptible Power Supplies
- Off-line UPS

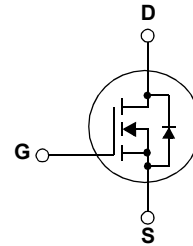
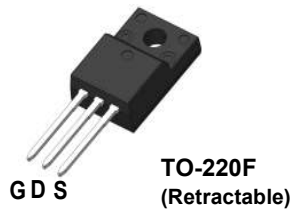

MOSFET Maximum Ratings $T_C = 25^\circ\text{C}$ unless otherwise noted*

Symbol	Parameter	Conditions	Ratings	Units
V_{DSS}	Drain to Source Voltage		100	V
V_{GSS}	Gate to Source Voltage		± 20	V
I_D	Drain Current	- Continuous ($T_C = 25^\circ\text{C}$)	67	A
		- Continuous ($T_C = 100^\circ\text{C}$)	47	
I_{DM}	Drain Current	- Pulsed (Note 1)	268	A
E_{AS}	Single Pulsed Avalanche Energy	(Note 2)	637	mJ
dv/dt	Peak Diode Recovery dv/dt	(Note 3)	6.0	V/ns
P_D	Power Dissipation	($T_C = 25^\circ\text{C}$)	43	W
		- Derate above 25°C	0.29	
T_J, T_{STG}	Operating and Storage Temperature Range		-55 to +175	$^\circ\text{C}$
T_L	Maximum Lead Temperature for Soldering Purpose, 1/8" from Case for 5 Seconds		300	$^\circ\text{C}$

Thermal Characteristics

Symbol	Parameter	Ratings	Units
$R_{\theta JC}$	Thermal Resistance, Junction to Case	3.5	$^\circ\text{C}/\text{W}$
$R_{\theta JA}$	Thermal Resistance, Junction to Ambient	62.5	

Package Marking and Ordering Information

Device Marking	Device	Package	Reel Size	Tape Width	Quantity
FDPF045N10A	FDPF045N10A	TO-220F	-	-	50

Electrical Characteristics $T_C = 25^\circ\text{C}$ unless otherwise noted

Symbol	Parameter	Test Conditions	Min.	Typ.	Max.	Units
--------	-----------	-----------------	------	------	------	-------

Off Characteristics

BV_{DSS}	Drain to Source Breakdown Voltage	$I_D = 250\mu\text{A}, V_{GS} = 0\text{V}$	100	-	-	V
$\frac{\Delta BV_{DSS}}{\Delta T_J}$	Breakdown Voltage Temperature Coefficient	$I_D = 250\mu\text{A}$, Referenced to 25°C	-	0.06	-	$\text{V}/^\circ\text{C}$
I_{DSS}	Zero Gate Voltage Drain Current	$V_{DS} = 80\text{V}, V_{GS} = 0\text{V}$ $V_{DS} = 80\text{V}, T_C = 150^\circ\text{C}$	-	-	1 500	μA
I_{GSS}	Gate to Body Leakage Current	$V_{GS} = \pm 20\text{V}, V_{DS} = 0\text{V}$	-	-	± 100	nA

On Characteristics

$V_{GS(th)}$	Gate Threshold Voltage	$V_{GS} = V_{DS}, I_D = 250\mu\text{A}$	2.0	-	4.0	V
$R_{DS(on)}$	Static Drain to Source On Resistance	$V_{GS} = 10\text{V}, I_D = 67\text{A}$	-	3.7	4.5	$\text{m}\Omega$
g_{FS}	Forward Transconductance	$V_{DS} = 10\text{V}, I_D = 67\text{A}$ (Note 4)	-	127	-	S

Dynamic Characteristics

C_{iss}	Input Capacitance	$V_{DS} = 50\text{V}, V_{GS} = 0\text{V}$ $f = 1\text{MHz}$	-	3961	5270	pF
C_{oss}	Output Capacitance		-	925	1230	pF
C_{rss}	Reverse Transfer Capacitance		-	34	-	pF
$C_{oss(er)}$	Energy Related Output Capacitance	$V_{DS} = 50\text{V}, V_{GS} = 0\text{V}$	-	1521	-	pF
$Q_{g(tot)}$	Total Gate Charge at 10V	$V_{GS} = 10\text{V}, V_{DS} = 50\text{V}$ $I_D = 100\text{A}$	-	57	74	nC
Q_{gs}	Gate to Source Gate Charge		-	17	-	nC
Q_{gs2}	Gate Charge Threshold to Plateau		-	8	-	nC
Q_{gd}	Gate to Drain "Miller" Charge		-	13	-	nC

Switching Characteristics

$t_{d(on)}$	Turn-On Delay Time	$V_{DD} = 50\text{V}, I_D = 100\text{A}$ $V_{GS} = 10\text{V}, R_{GEN} = 4.7\Omega$ (Note 4, 5)	-	23	56	ns
t_r	Turn-On Rise Time		-	26	62	ns
$t_{d(off)}$	Turn-Off Delay Time		-	50	110	ns
t_f	Turn-Off Fall Time		-	15	40	ns
ESR	Equivalent Series Resistance (G-S)	Drain Open, $f = 1\text{MHz}$	-	1.9	-	Ω

Drain-Source Diode Characteristics

I_S	Maximum Continuous Drain to Source Diode Forward Current	-	-	67	A	
I_{SM}	Maximum Pulsed Drain to Source Diode Forward Current	-	-	268	A	
V_{SD}	Drain to Source Diode Forward Voltage	$V_{GS} = 0\text{V}, I_{SD} = 67\text{A}$	-	-	1.3	V
t_{rr}	Reverse Recovery Time	$V_{GS} = 0\text{V}, V_{DD} = 50\text{V}, I_{SD} = 100\text{A}$	-	75	-	ns
Q_{rr}	Reverse Recovery Charge	$di_F/dt = 100\text{A}/\mu\text{s}$ (Note 4)	-	120	-	nC

Notes:

1. Repetitive Rating: Pulse width limited by maximum junction temperature
2. $L = 3\text{mH}, I_{AS} = 20.6\text{A}, R_G = 25\Omega$, Starting $T_J = 25^\circ\text{C}$
3. $I_{SD} \leq 100\text{A}, di/dt \leq 200\text{A}/\mu\text{s}, V_{DD} \leq BV_{DSS}$, Starting $T_J = 25^\circ\text{C}$
4. Pulse Test: Pulse width $\leq 300\mu\text{s}$, Dual Cycle $\leq 2\%$
5. Essentially Independent of Operating Temperature Typical Characteristics

Typical Performance Characteristics

Figure 1. On-Region Characteristics

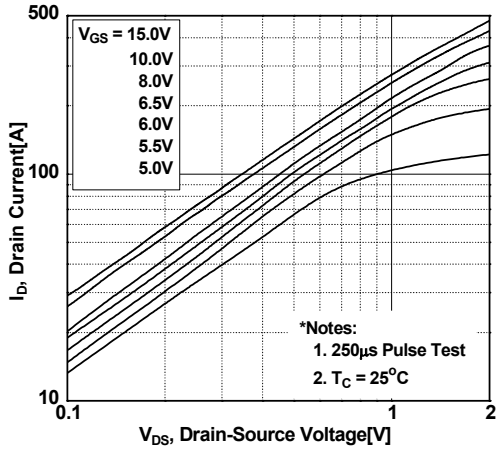

Figure 2. Transfer Characteristics

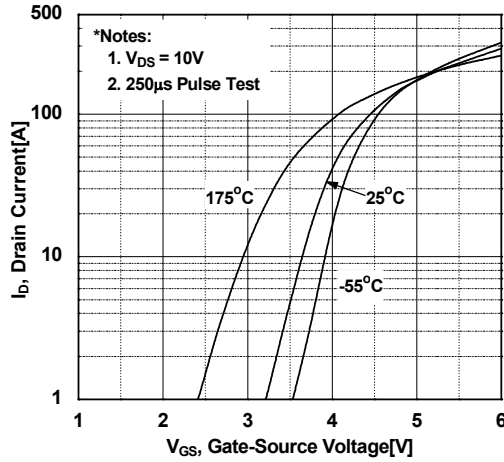

Figure 3. On-Resistance Variation vs. Drain Current and Gate Voltage

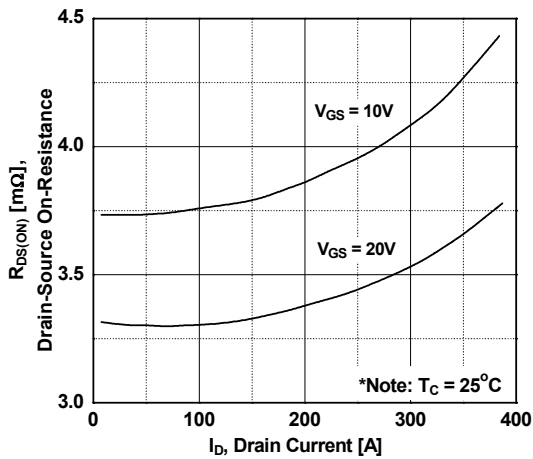

Figure 4. Body Diode Forward Voltage Variation vs. Source Current and Temperature

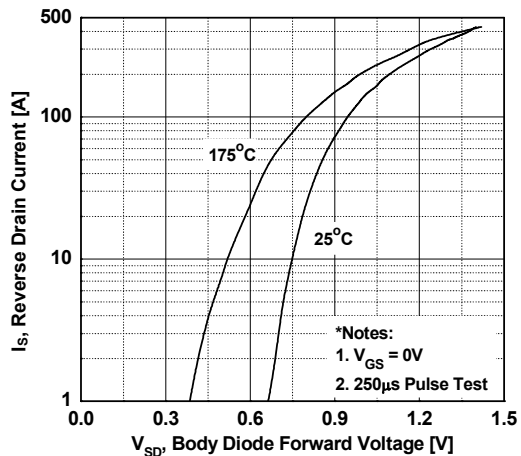

Figure 5. Capacitance Characteristics

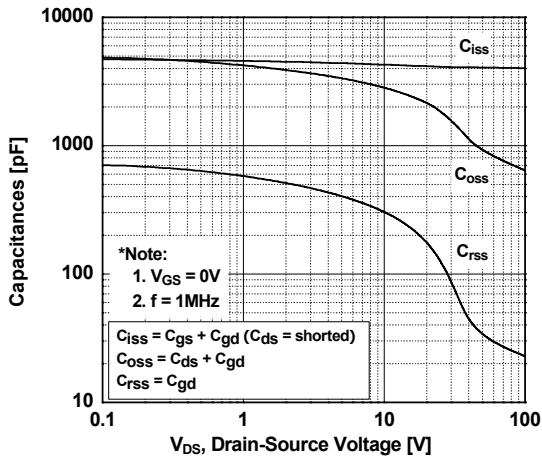
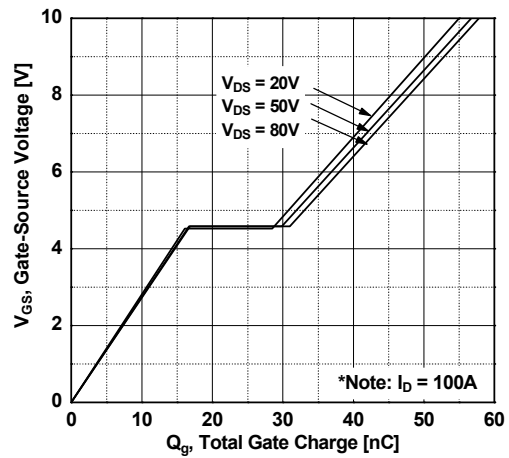

Figure 6. Gate Charge Characteristics



Typical Performance Characteristics (Continued)

Figure 7. Breakdown Voltage Variation vs. Temperature

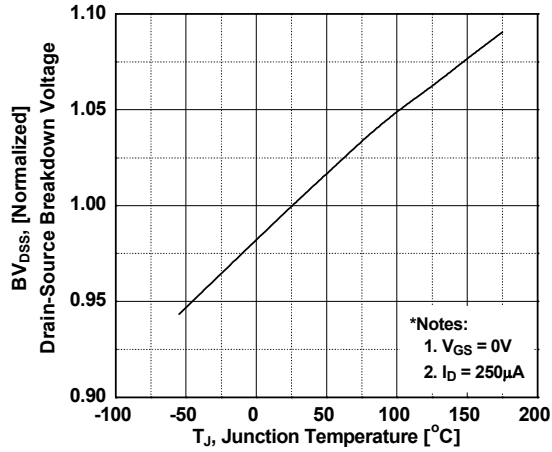

Figure 8. On-Resistance Variation vs. Temperature

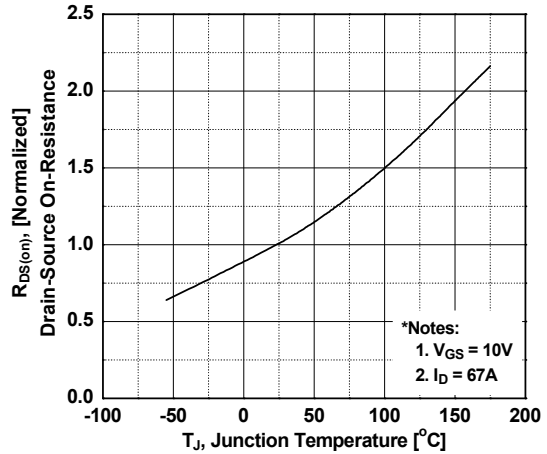

Figure 9. Maximum Safe Operating Area vs. Case Temperature

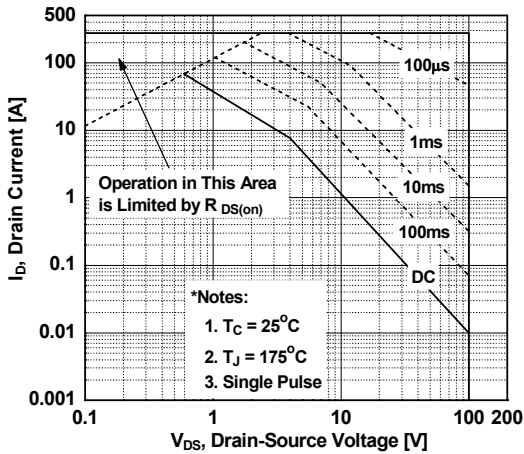

Figure 10. Maximum Drain Current

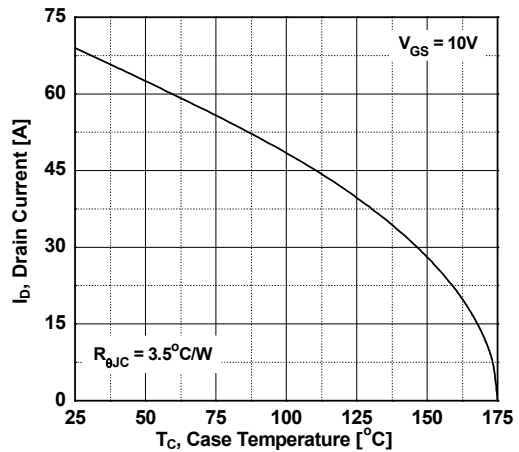
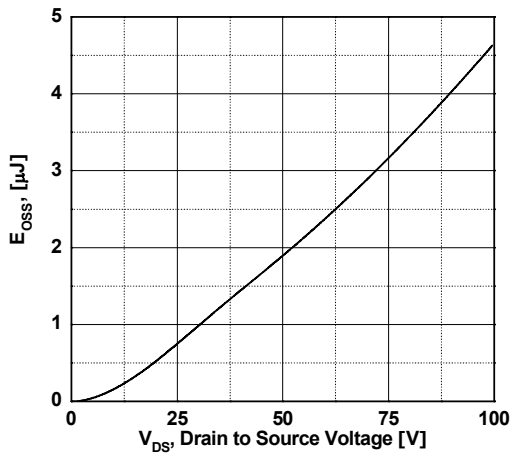
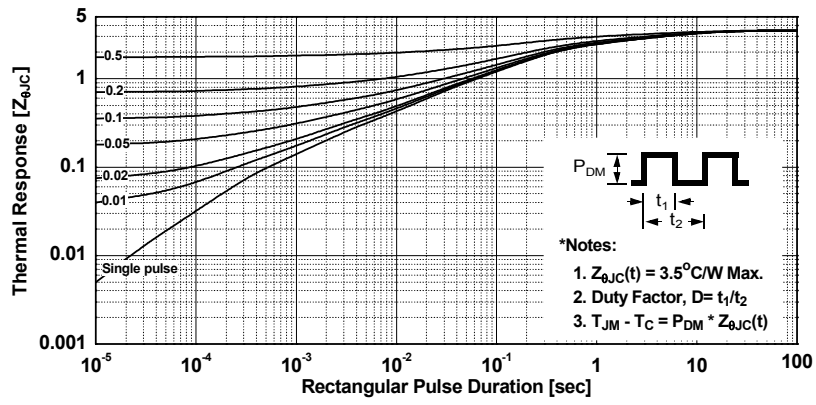

Figure 11. E_oss vs. Drain to Source Voltage



Typical Performance Characteristics (Continued)

Figure 12. Transient Thermal Response Curve



Gate Charge Test Circuit & Waveform

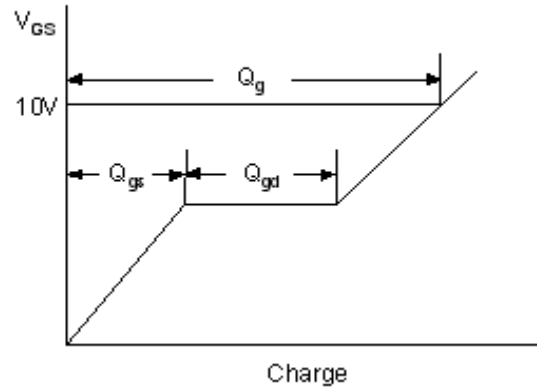
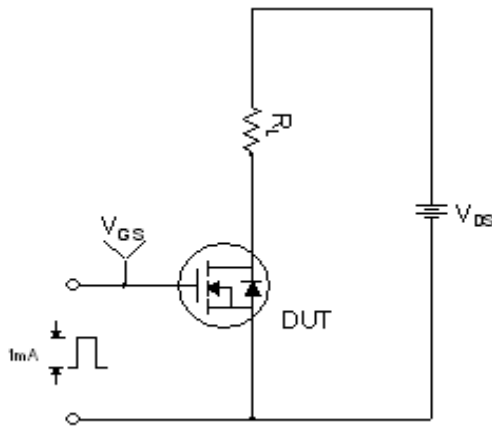

Resistive Switching Test Circuit & Waveforms

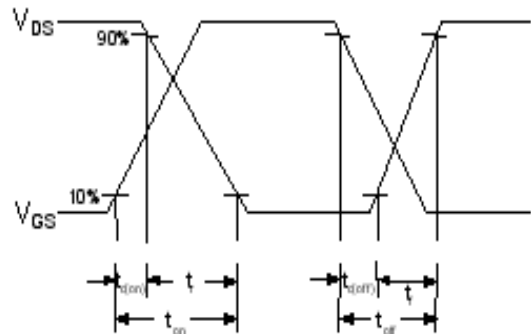
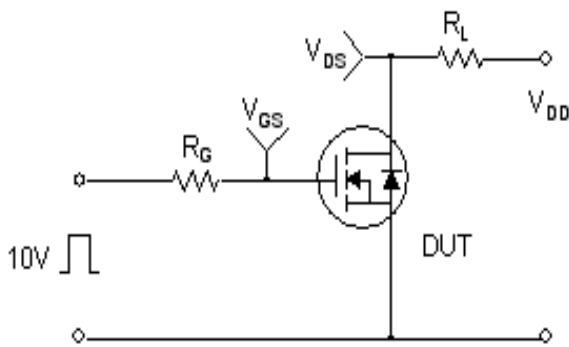

Unclamped Inductive Switching Test Circuit & Waveforms

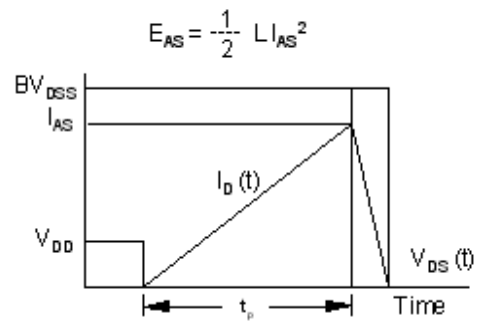
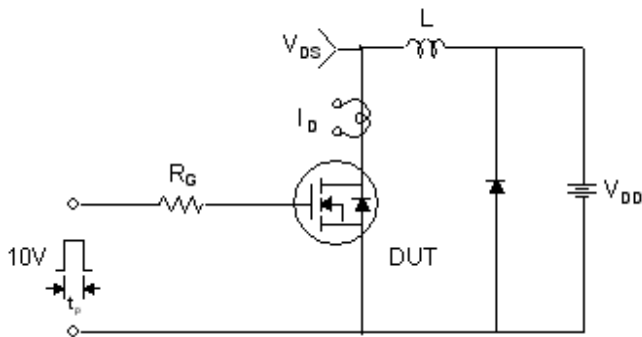

Peak Diode Recovery dv/dt Test Circuit & Waveforms

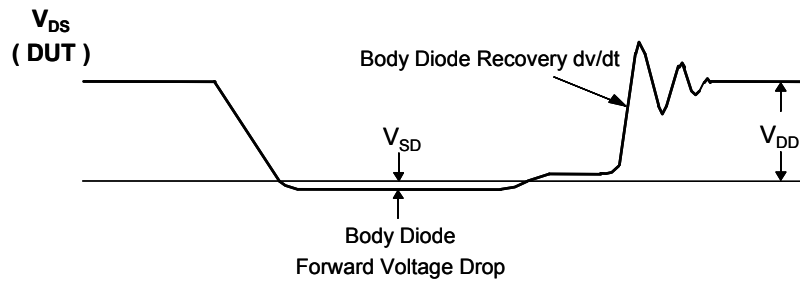
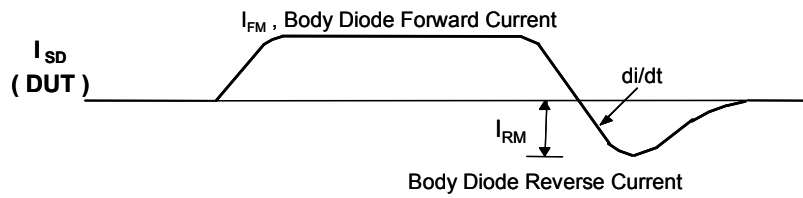
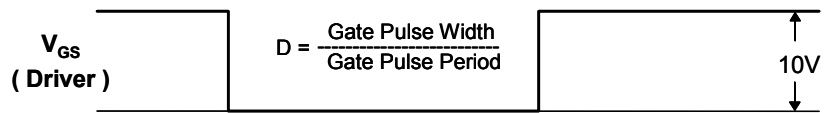
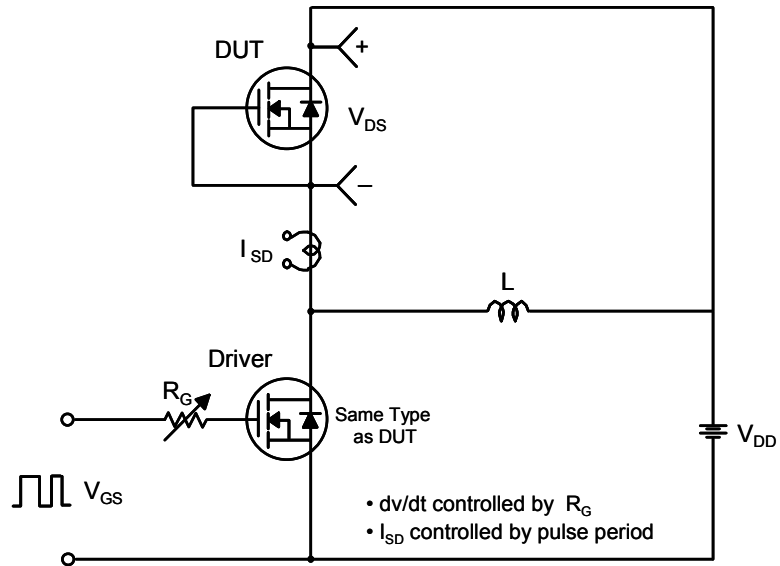

Package Dimensions

TO-220F (Retractable)

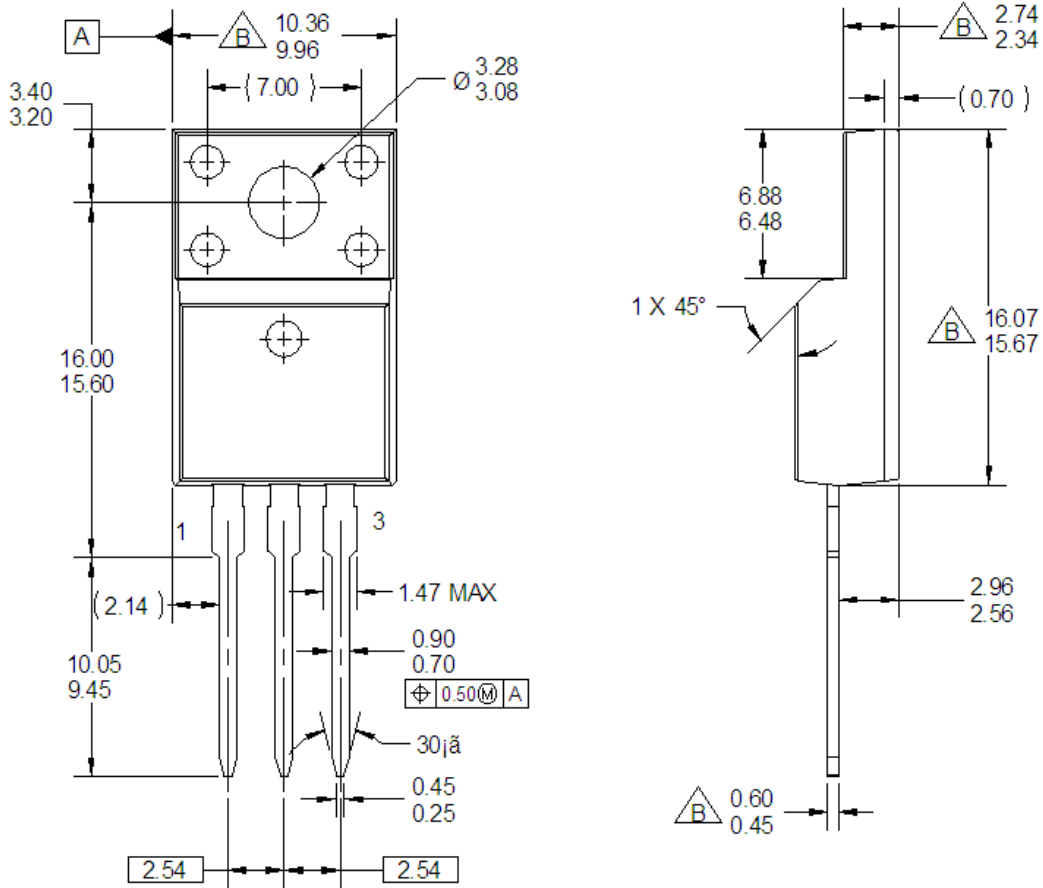

NOTES:

- A. EXCEPT WHERE NOTED CONFORMS TO EIAJ SC91A.
- B. DOES NOT COMPLY EIAJ STD. VALUE.
- C. ALL DIMENSIONS ARE IN MILLIMETERS.
- D. DIMENSIONS ARE EXCLUSIVE OF BURRS, MOLD FLASH AND TIE BAR PROTRUSIONS.
- E. DIMENSION AND TOLERANCE AS PER ASME Y14.5-1994.
- F. DRAWING FILE NAME: TO220M03REV1



*** Front/Back Side Isolation Voltage : AC 2500V**

Dimensions in Millimeters



TRADEMARKS

The following includes registered and unregistered trademarks and service marks, owned by Fairchild Semiconductor and/or its global subsidiaries, and is not intended to be an exhaustive list of all such trademarks.

- | | | | |
|---|-------------------------|---------------------------------------|---|
| 2Cool™ | FlashWriter® * | PDP SPM™ | The Power Franchise® |
| AccuPower™ | FPS™ | Power-SPM™ | The Right Technology for Your Success™ |
| Auto-SPM™ | F-PFS™ | PowerTrench® | |
| AX-CAP™* | FRFET® | PowerXS™ | the power® |
| BitSiC® | Global Power ResourceSM | Programmable Active Droop™ | franchise™ |
| Build it Now™ | Green FPS™ | QFET® | TinyBoost™ |
| CorePLUS™ | Green FPS™ e-Series™ | QS™ | TinyBuck™ |
| CorePOWER™ | Gmax™ | Quiet Series™ | TinyCalc™ |
| CROSSVOLT™ | GTO™ | RapidConfigure™ | TinyLogic® |
| CTL™ | IntelliMAX™ | | TINYOPTO™ |
| Current Transfer Logic™ | ISOPLANAR™ | Saving our world, 100 W/kW at a time™ | TinyPower™ |
| DEUXPEED® | MegaBuck™ | SignalWise™ | TinyPWM™ |
| Dual Cool™ | MICROCOUPLER™ | SmartMax™ | TinyWire™ |
| EcoSPARK® | MicroFET™ | SMART START™ | TranSiC® |
| EfficientMax™ | MicroPak™ | SPM® | TriFault Detect™ |
| ESBC™ | MicroPak2™ | STEALTH™ | TRUECURRENT®* |
|  | MillerDrive™ | SuperFET® | uSerDes™ |
| Fairchild® | MotionMax™ | SuperSOT™_3 |  |
| Fairchild Semiconductor® | Motion-SPM™ | SuperSOT™_6 | UHC® |
| FACT Quiet Series™ | mWSaver™ | SuperSOT™_8 | Ultra FRFET™ |
| FACT® | OptiHIT™ | SupreMOS® | UniFET™ |
| FAST® | OPTOLOGIC® | SyncFET™ | VCX™ |
| FastvCore™ | OPTOPLANAR® | Sync-Lock™ | VisualMax™ |
| FETBench™ | | | XS™ |

*Trademarks of System General Corporation, used under license by Fairchild Semiconductor.

DISCLAIMER

FAIRCHILD SEMICONDUCTOR RESERVES THE RIGHT TO MAKE CHANGES WITHOUT FURTHER NOTICE TO ANY PRODUCTS HEREIN TO IMPROVE RELIABILITY, FUNCTION, OR DESIGN. FAIRCHILD DOES NOT ASSUME ANY LIABILITY ARISING OUT OF THE APPLICATION OR USE OF ANY PRODUCT OR CIRCUIT DESCRIBED HEREIN; NEITHER DOES IT CONVEY ANY LICENSE UNDER ITS PATENT RIGHTS, NOR THE RIGHTS OF OTHERS. THESE SPECIFICATIONS DO NOT EXPAND THE TERMS OF FAIRCHILD'S WORLDWIDE TERMS AND CONDITIONS, SPECIFICALLY THE WARRANTY THEREIN, WHICH COVERS THESE PRODUCTS.

LIFE SUPPORT POLICY

FAIRCHILD'S PRODUCTS ARE NOT AUTHORIZED FOR USE AS CRITICAL COMPONENTS IN LIFE SUPPORT DEVICES OR SYSTEMS WITHOUT THE EXPRESS WRITTEN APPROVAL OF FAIRCHILD SEMICONDUCTOR CORPORATION.

As used here in:

1. Life support devices or systems are devices or systems which, (a) are intended for surgical implant into the body or (b) support or sustain life, and (c) whose failure to perform when properly used in accordance with instructions for use provided in the labeling, can be reasonably expected to result in a significant injury of the user.
2. A critical component in any component of a life support, device, or system whose failure to perform can be reasonably expected to cause the failure of the life support device or system, or to affect its safety or effectiveness.

ANTI-COUNTERFEITING POLICY

Fairchild Semiconductor Corporation's Anti-Counterfeiting Policy. Fairchild's Anti-Counterfeiting Policy is also stated on our external website, www.fairchildsemi.com, under Sales Support.

Counterfeiting of semiconductor parts is a growing problem in the industry. All manufactures of semiconductor products are experiencing counterfeiting of their parts. Customers who inadvertently purchase counterfeit parts experience many problems such as loss of brand reputation, substandard performance, failed application, and increased cost of production and manufacturing delays. Fairchild is taking strong measures to protect ourselves and our customers from the proliferation of counterfeit parts. Fairchild strongly encourages customers to purchase Fairchild parts either directly from Fairchild or from Authorized Fairchild Distributors who are listed by country on our web page cited above. Products customers buy either from Fairchild directly or from Authorized Fairchild Distributors are genuine parts, have full traceability, meet Fairchild's quality standards for handling and storage and provide access to Fairchild's full range of up-to-date technical and product information. Fairchild and our Authorized Distributors will stand behind all warranties and will appropriately address and warranty issues that may arise. Fairchild will not provide any warranty coverage or other assistance for parts bought from Unauthorized Sources. Fairchild is committed to combat this global problem and encourage our customers to do their part in stopping this practice by buying direct or from authorized distributors.

PRODUCT STATUS DEFINITIONS

Definition of Terms

Datasheet Identification	Product Status	Definition
Advance Information	Formative / In Design	Datasheet contains the design specifications for product development. Specifications may change in any manner without notice.
Preliminary	First Production	Datasheet contains preliminary data; supplementary data will be published at a later date. Fairchild Semiconductor reserves the right to make changes at any time without notice to improve design.
No Identification Needed	Full Production	Datasheet contains final specifications. Fairchild Semiconductor reserves the right to make changes at any time without notice to improve the design.
Obsolete	Not In Production	Datasheet contains specifications on a product that is discontinued by Fairchild Semiconductor. The datasheet is for reference information only.