

# FQPF6N80T

## 800V N-Channel MOSFET

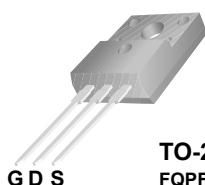
### General Description

These N-Channel enhancement mode power field effect transistors are produced using Fairchild's proprietary, planar stripe, DMOS technology.

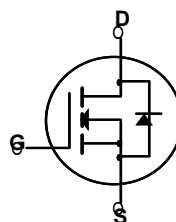
This advanced technology has been especially tailored to minimize on-state resistance, provide superior switching performance, and withstand high energy pulse in the avalanche and commutation mode. These devices are well suited for high efficiency switch mode power supply.

### Features

- 3.3A, 800V,  $R_{DS(on)} = 1.95\Omega @ V_{GS} = 10V$
- Low gate charge ( typical 31 nC)
- Low Crss ( typical 14 pF)
- Fast switching
- 100% avalanche tested
- Improved dv/dt capability
- 100% package isolation tested (Note 6)



**TO-220F Potted**  
FQPF Series



### Absolute Maximum Ratings T<sub>C</sub> = 25°C unless otherwise noted

Symbol	Parameter	FQPF6N80T	Units
V <sub>DSS</sub>	Drain-Source Voltage	800	V
I <sub>D</sub>	Drain Current - Continuous (T <sub>C</sub> = 25°C) - Continuous (T <sub>C</sub> = 100°C)	3.3	A
		2.1	A
I <sub>DM</sub>	Drain Current - Pulsed (Note 1)	13.2	A
V <sub>GSS</sub>	Gate-Source Voltage	± 30	V
E <sub>AS</sub>	Single Pulsed Avalanche Energy (Note 2)	680	mJ
I <sub>AR</sub>	Avalanche Current (Note 1)	3.3	A
E <sub>AR</sub>	Repetitive Avalanche Energy (Note 1)	5.1	mJ
dv/dt	Peak Diode Recovery dv/dt (Note 3)	4.0	V/ns
P <sub>D</sub>	Power Dissipation (T <sub>C</sub> = 25°C) - Derate above 25°C	51	W
		0.41	W/°C
T <sub>J</sub> , T <sub>STG</sub>	Operating and Storage Temperature Range	-55 to +150	°C
T <sub>L</sub>	Maximum lead temperature for soldering purposes, 1/8" from case for 5 seconds	300	°C

### Thermal Characteristics

Symbol	Parameter	Typ	Max	Units
R <sub>θJC</sub>	Thermal Resistance, Junction-to-Case	--	2.45	°C/W
R <sub>θJA</sub>	Thermal Resistance, Junction-to-Ambient	--	62.5	°C/W

## Electrical Characteristics

$T_C = 25^\circ\text{C}$  unless otherwise noted

Symbol	Parameter	Test Conditions	Min	Typ	Max	Units
<b>Off Characteristics</b>						
$BV_{DSS}$	Drain-Source Breakdown Voltage	$V_{GS} = 0\text{ V}, I_D = 250\ \mu\text{A}$	800	--	--	V
$\Delta BV_{DSS} / \Delta T_J$	Breakdown Voltage Temperature Coefficient	$I_D = 250\ \mu\text{A}$ , Referenced to $25^\circ\text{C}$	--	0.9	--	$\text{V}/^\circ\text{C}$
$I_{DSS}$	Zero Gate Voltage Drain Current	$V_{DS} = 800\text{ V}, V_{GS} = 0\text{ V}$	--	--	10	$\mu\text{A}$
		$V_{DS} = 640\text{ V}, T_C = 125^\circ\text{C}$	--	--	100	$\mu\text{A}$
$I_{GSSF}$	Gate-Body Leakage Current, Forward	$V_{GS} = 30\text{ V}, V_{DS} = 0\text{ V}$	--	--	100	nA
$I_{GSSR}$	Gate-Body Leakage Current, Reverse	$V_{GS} = -30\text{ V}, V_{DS} = 0\text{ V}$	--	--	-100	nA

### On Characteristics

$V_{GS(th)}$	Gate Threshold Voltage	$V_{DS} = V_{GS}, I_D = 250\ \mu\text{A}$	3.0	--	5.0	V
$R_{DS(on)}$	Static Drain-Source On-Resistance	$V_{GS} = 10\text{ V}, I_D = 1.65\text{ A}$	--	1.5	1.95	$\Omega$
$g_{FS}$	Forward Transconductance	$V_{DS} = 50\text{ V}, I_D = 1.65\text{ A}$ (Note 4)	--	4.3	--	S

### Dynamic Characteristics

$C_{iss}$	Input Capacitance	$V_{DS} = 25\text{ V}, V_{GS} = 0\text{ V},$ $f = 1.0\text{ MHz}$	--	1150	1500	pF
$C_{oss}$	Output Capacitance		--	125	160	pF
$C_{rss}$	Reverse Transfer Capacitance		--	14	18	pF

### Switching Characteristics

$t_{d(on)}$	Turn-On Delay Time	$V_{DD} = 400\text{ V}, I_D = 5.8\text{ A},$ $R_G = 25\ \Omega$	--	30	70	ns	
$t_r$	Turn-On Rise Time		--	70	150	ns	
$t_{d(off)}$	Turn-Off Delay Time		(Note 4,5)	--	65	140	ns
$t_f$	Turn-Off Fall Time		(Note 4,5)	--	45	100	ns
$Q_g$	Total Gate Charge	$V_{DS} = 640\text{ V}, I_D = 5.8\text{ A},$ $V_{GS} = 10\text{ V}$	--	31	--	nC	
$Q_{gs}$	Gate-Source Charge		(Note 4,5)	--	7.1	--	nC
$Q_{gd}$	Gate-Drain Charge		(Note 4,5)	--	15	--	nC

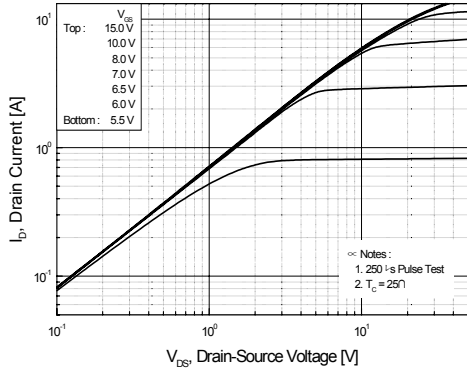
### Drain-Source Diode Characteristics and Maximum Ratings

$I_S$	Maximum Continuous Drain-Source Diode Forward Current	--	--	3.3	A	
$I_{SM}$	Maximum Pulsed Drain-Source Diode Forward Current	--	--	13.2	A	
$V_{SD}$	Drain-Source Diode Forward Voltage	$V_{GS} = 0\text{ V}, I_S = 3.3\text{ A}$	--	--	1.4	V
$t_{rr}$	Reverse Recovery Time	$V_{GS} = 0\text{ V}, I_S = 5.8\text{ A},$	--	650	--	ns
$Q_{rr}$	Reverse Recovery Charge	$di_F / dt = 100\text{ A}/\mu\text{s}$ (Note 4)	--	5.7	--	$\mu\text{C}$

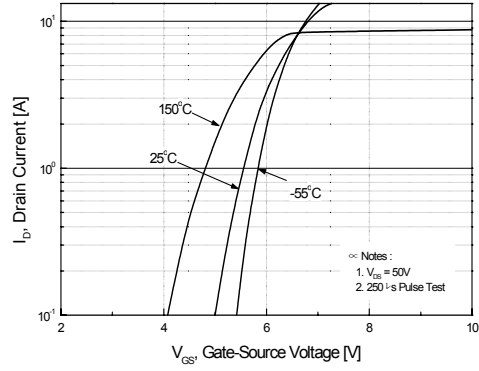
#### Notes:

1. Repetitive Rating : Pulse width limited by maximum junction temperature
2.  $L = 117\text{ mH}, I_{AS} = 3.3\text{ A}, V_{DD} = 50\text{ V}, R_G = 25\ \Omega$ , Starting  $T_J = 25^\circ\text{C}$
3.  $I_{SD}$  is 5.8A,  $di/dt$  is 200A/ $\mu\text{s}$ ,  $V_{DD}$  is  $BV_{DSS}$ , Starting  $T_J = 25^\circ\text{C}$
4. Pulse Test : Pulse width is 300 $\mu\text{s}$ , Duty cycle is 2%
5. Essentially independent of operating temperature
6. Viso=4000V, t=0.3s in single pulse, UL recognized

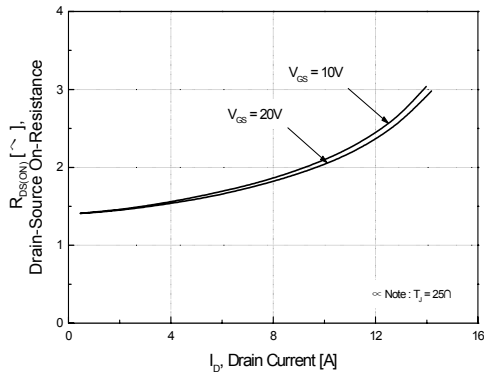
## Typical Characteristics



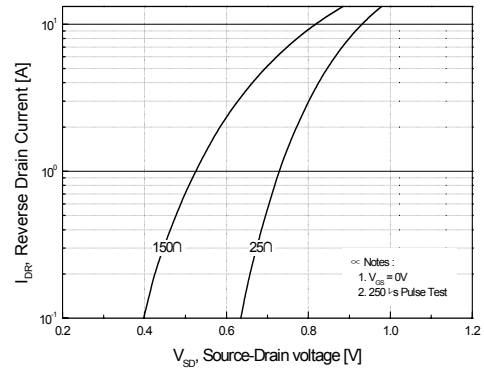
**Figure 1. On-Region Characteristics**



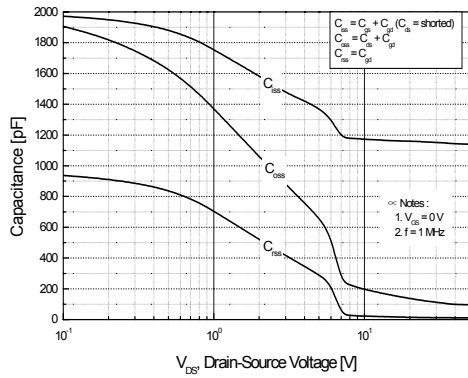
**Figure 2. Transfer Characteristics**



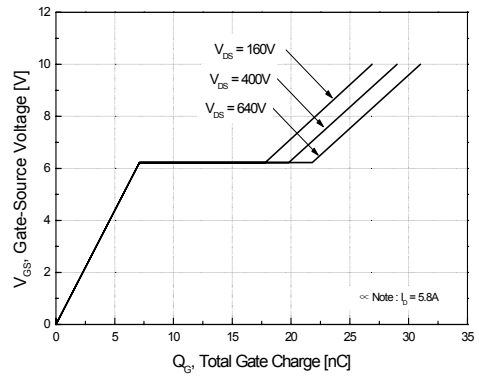
**Figure 3. On-Resistance Variation vs. Drain Current and Gate Voltage**



**Figure 4. Body Diode Forward Voltage Variation with Source Current and Temperature**

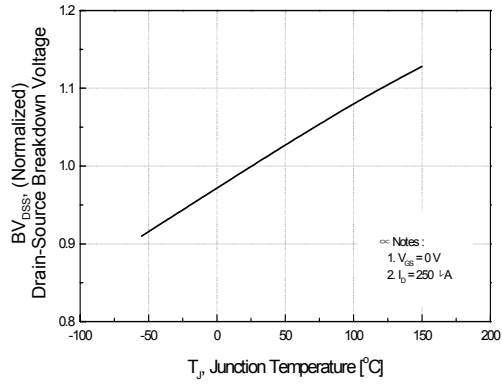


**Figure 5. Capacitance Characteristics**

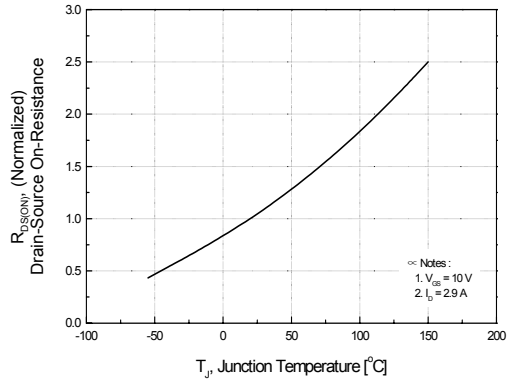


**Figure 6. Gate Charge Characteristics**

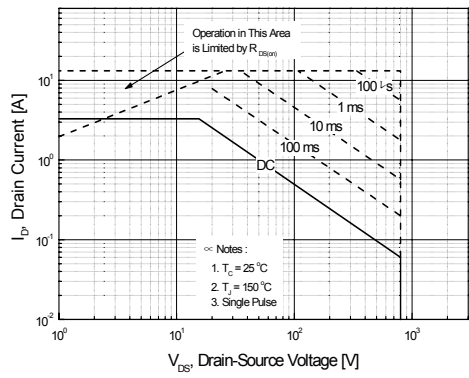
**Typical Characteristics** (Continued)



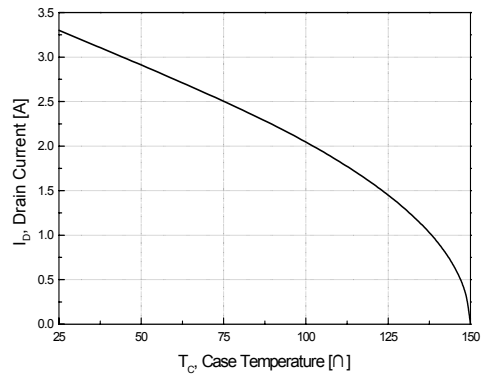
**Figure 7. Breakdown Voltage Variation vs Temperature**



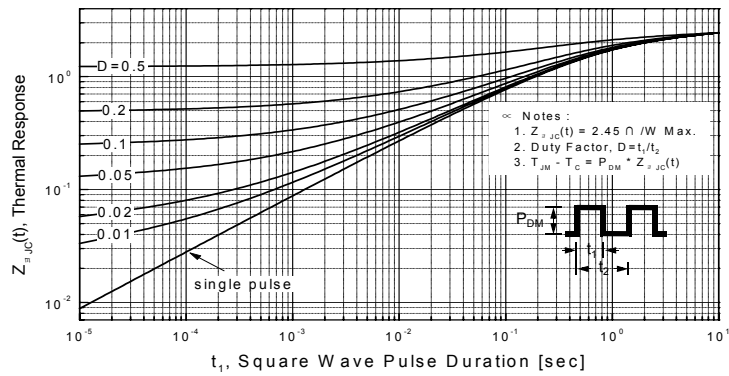
**Figure 8. On-Resistance Variation vs Temperature**



**Figure 9. Maximum Safe Operating Area**

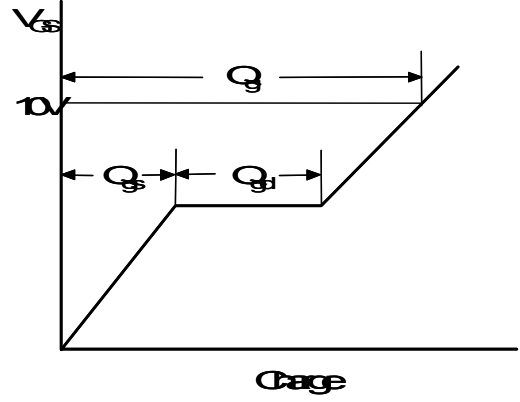
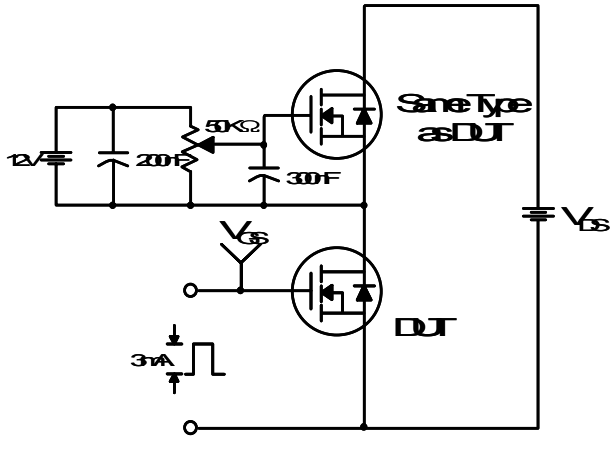


**Figure 10. Maximum Drain Current vs Case Temperature**

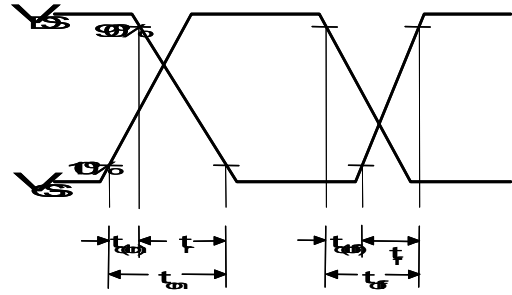
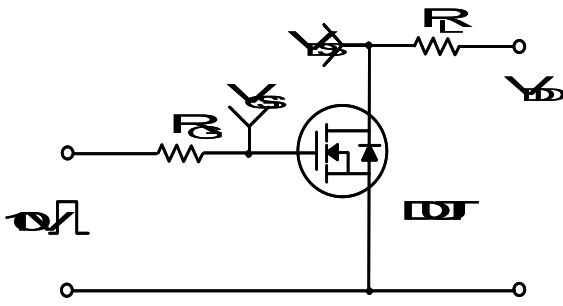


**Figure 11. Transient Thermal Response Curve**

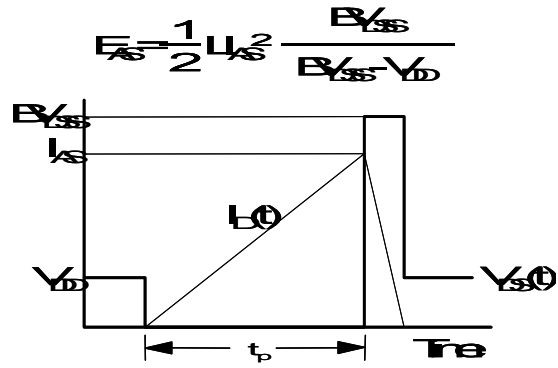
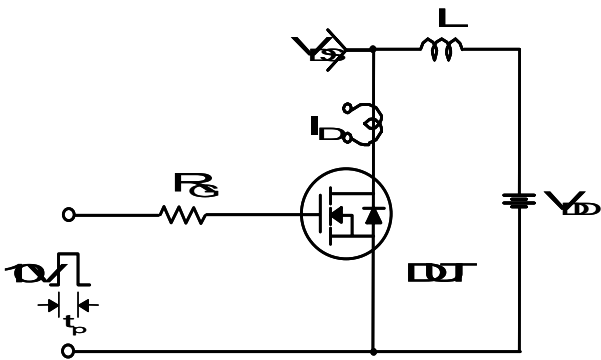
Gate Charge Test Circuit & Waveform



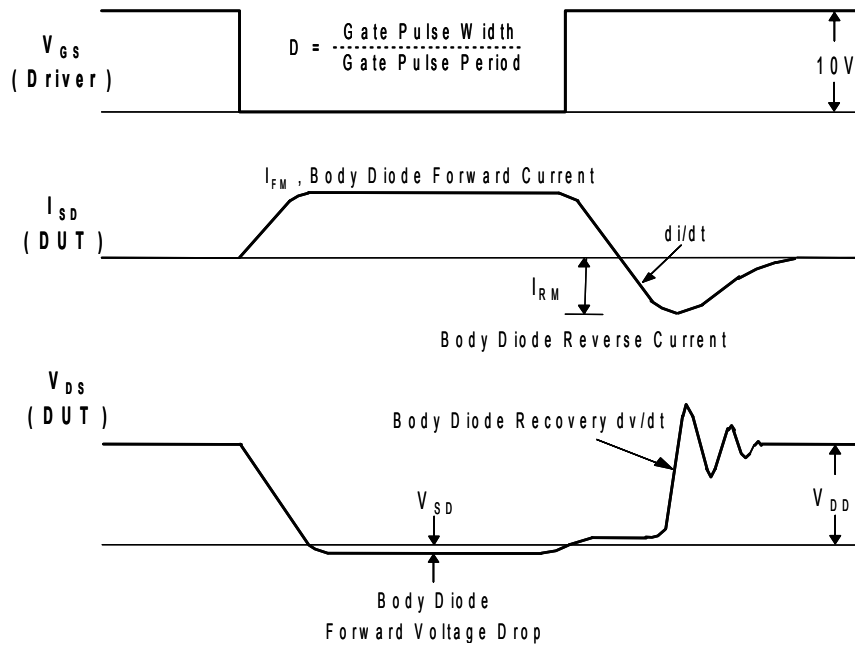
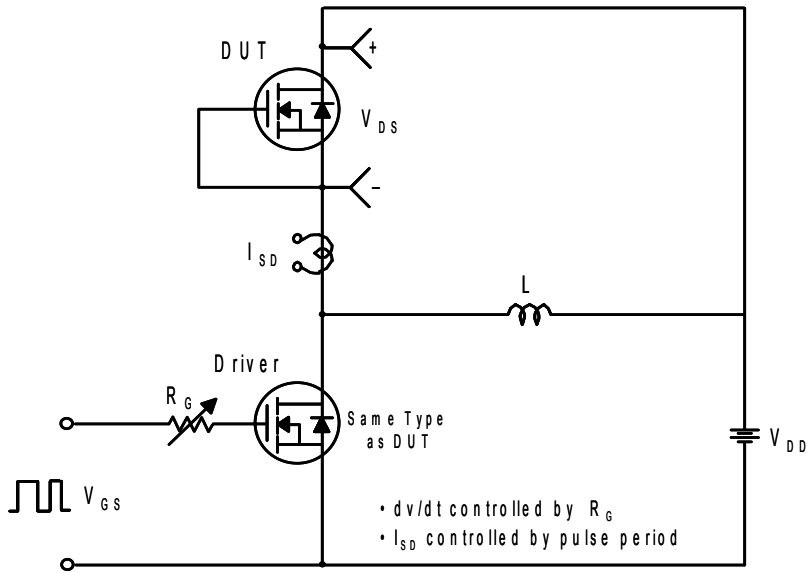
Resistive Switching Test Circuit & Waveforms



Unclamped Inductive Switching Test Circuit & Waveforms

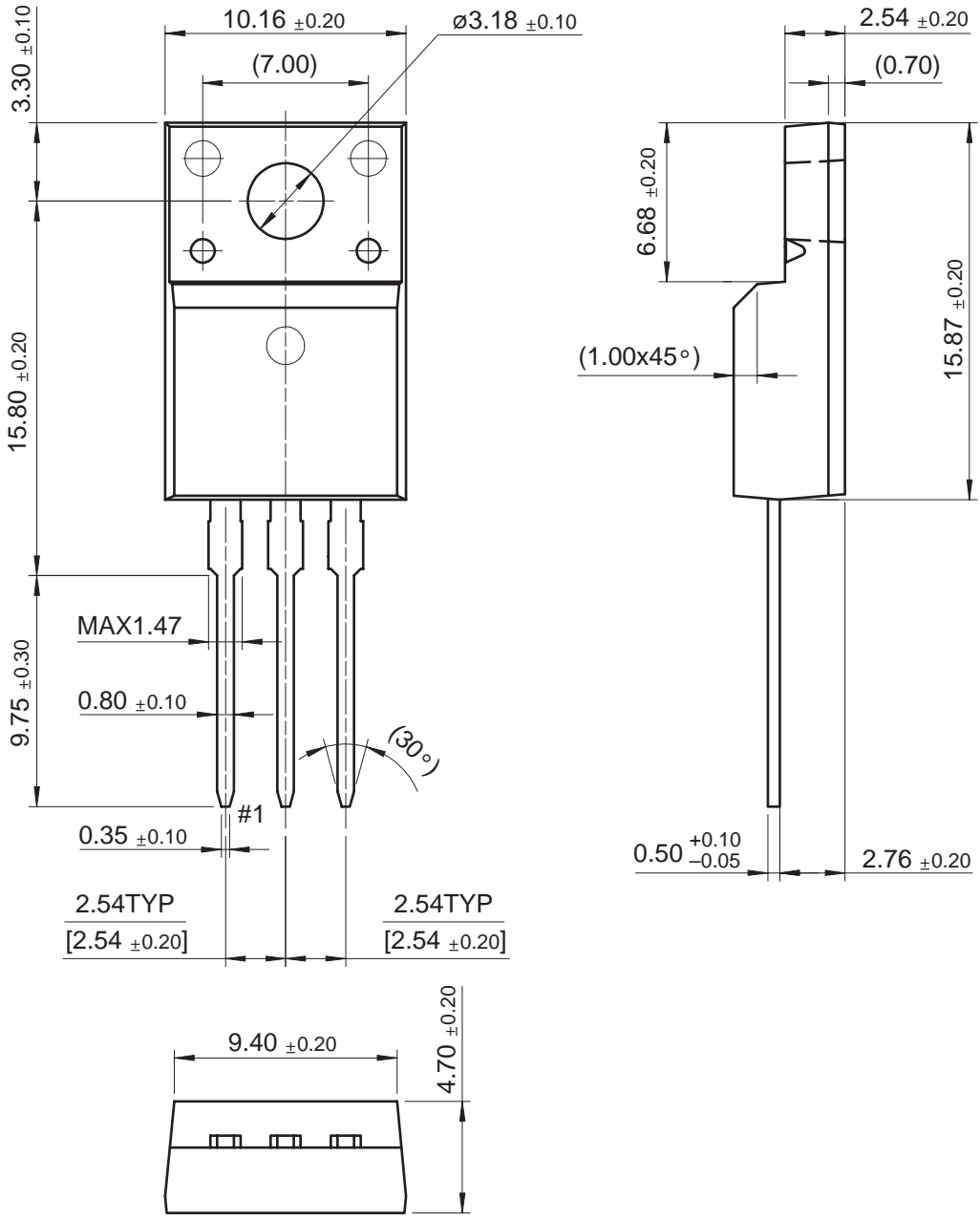


Peak Diode Recovery dv/dt Test Circuit & Waveforms



Package Dimensions

TO-220F Potted









Dimensions in Millimeters



**TRADEMARKS**

The following includes registered and unregistered trademarks and service marks, owned by Fairchild Semiconductor and/or its global subsidiaries, and is not intended to be an exhaustive list of all such trademarks.

- |   |   |  |   |
|---|---|--|---|
| AccuPower™  | FPS™  | PowerTrench®   | The Power Franchise®  |
| Auto-SPM™   | F-PFS™  | PowerXS™   | the power®  |
| Build it Now™   | FRFET®  | Programmable Active Droop™   | franchise   |
| CorePLUS™   | Global Power ResourceSM   | QFET®  | TinyBoost™  |
| CorePOWER™  | Green FPS™  | QS™  | TinyBuck™   |
| CROSSVOLT™  | Green FPS™ e-Series™  | Quiet Series™  | TinyCalc™   |
| CTL™  | Gmax™   | RapidConfigure™  | TinyLogic®  |
| Current Transfer Logic™   | GTO™  |  ™        | TINYOPTO™   |
| EcoSPARK®   | IntelliMAX™   | Saving our world, 1mW /W /kW at a time™  | TinyPower™  |
| EfficientMax™   | ISOPLANAR™  | SmartMax™  | TinyPWM™  |
| EZSWITCH™*  | MegaBuck™   | SMART START™   | TinyWire™   |
|  | MICROCOUPLER™   | SPM®   | TriFault Detect™  |
|  | MicroFET™   | STEALTH™   | TRUECURRENT™*   |
| Fairchild®  | MicroPak™   | SuperFET™  |  |
| Fairchild Semiconductor®  | MillerDrive™  | SuperSOT™-3  | UHC®  |
| FACT Quiet Series™  | MotionMax™  | SuperSOT™-6  | Ultra FRFET™  |
| FACT®   | Motion-SPM™   | SuperSOT™-8  | UniFET™   |
| FAST®   | OPTOLOGIC®  | SupreMOS™  | VCX™  |
| FastvCore™  | OPTOPLANAR®   | SyncFET™   | VisualMax™  |
| FETBench™   |  | Sync-Lock™   | XS™   |
| FlashWriter®*   | PDP SPM™  |  SYSTEM®* |   |
|   | Power-SPM™  | GENERAL  |   |

\*Trademarks of System General Corporation, used under license by Fairchild Semiconductor.

**DISCLAIMER**

FAIRCHILD SEMICONDUCTOR RESERVES THE RIGHT TO MAKE CHANGES WITHOUT FURTHER NOTICE TO ANY PRODUCTS HEREIN TO IMPROVE RELIABILITY, FUNCTION, OR DESIGN. FAIRCHILD DOES NOT ASSUME ANY LIABILITY ARISING OUT OF THE APPLICATION OR USE OF ANY PRODUCT OR CIRCUIT DESCRIBED HEREIN; NEITHER DOES IT CONVEY ANY LICENSE UNDER ITS PATENT RIGHTS, NOR THE RIGHTS OF OTHERS. THESE SPECIFICATIONS DO NOT EXPAND THE TERMS OF FAIRCHILD'S WORLDWIDE TERMS AND CONDITIONS, SPECIFICALLY THE WARRANTY THEREIN, WHICH COVERS THESE PRODUCTS.

**LIFE SUPPORT POLICY**

FAIRCHILD'S PRODUCTS ARE NOT AUTHORIZED FOR USE AS CRITICAL COMPONENTS IN LIFE SUPPORT DEVICES OR SYSTEMS WITHOUT THE EXPRESS WRITTEN APPROVAL OF FAIRCHILD SEMICONDUCTOR CORPORATION.

As used herein:

1. Life support devices or systems are devices or systems which, (a) are intended for surgical implant into the body or (b) support or sustain life, and (c) whose failure to perform when properly used in accordance with instructions for use provided in the labeling, can be reasonably expected to result in a significant injury of the user.
2. A critical component in any component of a life support, device, or system whose failure to perform can be reasonably expected to cause the failure of the life support device or system, or to affect its safety or effectiveness.

**ANTI-COUNTERFEITING POLICY**

Fairchild Semiconductor Corporation's Anti-Counterfeiting Policy. Fairchild's Anti-Counterfeiting Policy is also stated on our external website, www.Fairchildsemi.com, under Sales Support.

Counterfeiting of semiconductor parts is a growing problem in the industry. All manufactures of semiconductor products are experiencing counterfeiting of their parts. Customers who inadvertently purchase counterfeit parts experience many problems such as loss of brand reputation, substandard performance, failed application, and increased cost of production and manufacturing delays. Fairchild is taking strong measures to protect ourselves and our customers from the proliferation of counterfeit parts. Fairchild strongly encourages customers to purchase Fairchild parts either directly from Fairchild or from Authorized Fairchild Distributors who are listed by country on our web page cited above. Products customers buy either from Fairchild directly or from Authorized Fairchild Distributors are genuine parts, have full traceability, meet Fairchild's quality standards for handling and storage and provide access to Fairchild's full range of up-to-date technical and product information. Fairchild and our Authorized Distributors will stand behind all warranties and will appropriately address and warranty issues that may arise. Fairchild will not provide any warranty coverage or other assistance for parts bought from Unauthorized Sources. Fairchild is committed to combat this global problem and encourage our customers to do their part in stopping this practice by buying direct or from authorized distributors.

**PRODUCT STATUS DEFINITIONS**

**Definition of Terms**

Datasheet Identification	Product Status	Definition
Advance Information	Formative / In Design	Datasheet contains the design specifications for product development. Specifications may change in any manner without notice.
Preliminary	First Production	Datasheet contains preliminary data; supplementary data will be published at a later date. Fairchild Semiconductor reserves the right to make changes at any time without notice to improve design.
No Identification Needed	Full Production	Datasheet contains final specifications. Fairchild Semiconductor reserves the right to make changes at any time without notice to improve the design.
Obsolete	Not In Production	Datasheet contains specifications on a product that is discontinued by Fairchild Semiconductor. The datasheet is for reference information only.