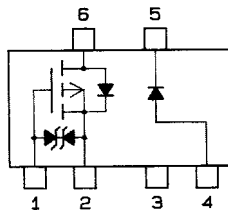

**FX851**MOSFET:P-Channel Silicon MOSFET  
SBD:Schottky Barrier Diode**DC-DC Converter Applications****Features**

- Composite type composed of a low ON-resistance P-channel MOSFET for ultrahigh-speed switching and low-voltage driving and a fast-recovery, low forward-voltage Schottky barrier diode. Facilitates high-density mounting.
- The FX851 is formed with 2 chips, one being equivalent to the 2SJ187 and the other the SB07-03P, placed in one package.

**Electrical Connection**

- 1:Gate  
2:Source  
3:No connection  
4:Anode  
5:Cathode  
6:Drain

(Top view)

**Package Dimensions**

unit:mm

2119

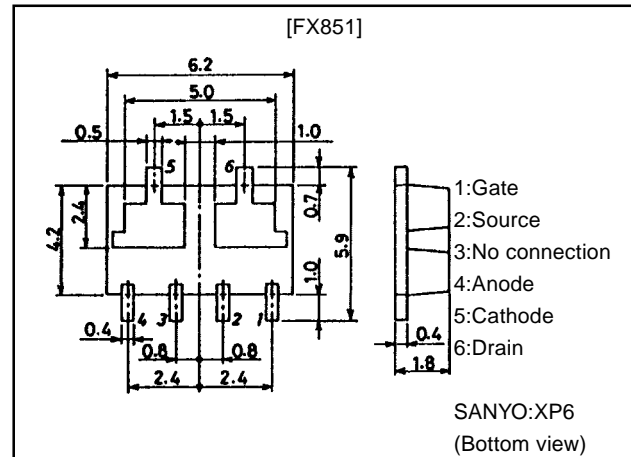
**Specifications****Absolute Maximum Ratings at Ta = 25°C**

Parameter	Symbol	Conditions	Ratings	Unit
[MOSFET]				
Drain-to-Source Voltage	$V_{DSS}$		-30	V
Gate-to-Source Voltage	$V_{GSS}$		±15	V
Drain Current (DC)	$I_D$		-1	A
Drain Current (Pulse)	$I_{DP}$	$PW \leq 10\mu s$ , duty cycle $\leq 1\%$	-4	A
Allowable Power Dissipation	$P_D$	$T_c = 25^\circ C$	6	W
		Mounted on ceramic board (750mm <sup>2</sup> × 0.8mm)	1.5	W
Channel Temperature	$T_{ch}$		150	°C
Storage Temperature	$T_{stg}$		-55 to +150	°C
[SBD]				
Repetitive Peak Reverse Voltage	$V_{RRM}$		30	V
Non-repetitive Peak Reverse Surge Voltage	$V_{RSM}$		35	V
Average Rectified Current	$I_O$		700	mA
Surge Forward Current	$I_{FSM}$	50Hz sine wave, 1 cycle	5	A
Junction Temperature	$T_j$		-55 to +125	°C
Storage Temperature	$T_{stg}$		-55 to +150	°C

· Marking:851

Continued on next page.

# FX851

Continued from preceding page.

## Electrical Characteristics at Ta = 25°C

Parameter	Symbol	Conditions	Ratings			Unit
			min	typ	max	
[MOSFET]						
D-S Breakdown Voltage	$V_{(BR)DSS}$	$I_D = -1mA, V_{GS} = 0$	-30			V
Zero-Gate Voltage Drain Current	$I_{DSS}$	$V_{DS} = -30V, V_{GS} = 0$			-100	$\mu A$
Gate-to-Source Leakage Current	$I_{GSS}$	$V_{GS} = \pm 12V, V_{DS} = 0$			$\pm 10$	$\mu A$
Cutoff Voltage	$V_{GS(off)}$	$V_{DS} = -10V, I_D = -1mA$	-1.0		-2.0	V
Forward Transfer Admittance	$ Y_{fs} $	$V_{DS} = -10V, I_D = -500mA$	0.6	1.0		S
Static Drain-to-Source ON-State Resistance	$R_{DS(on)}$	$I_D = -500mA, V_{GS} = -10V$		0.5	0.75	$\Omega$
	$R_{DS(on)}$	$I_D = -500mA, V_{GS} = -4V$		0.75	1.1	$\Omega$
Input Capacitance	$C_{iss}$	$V_{DS} = -10V, f = 1MHz$		170		pF
Output Capacitance	$C_{oss}$	$V_{DS} = -10V, f = 1MHz$		110		pF
Reverse Transfer Capacitance	$C_{rss}$	$V_{DS} = -10V, f = 1MHz$		20		pF
Turn-ON Delay Time	$t_{d(on)}$	See specified Test Circuit		10		ns
Rise Time	$t_r$	See specified Test Circuit		13		ns
Turn-OFF Delay Time	$t_{d(off)}$	See specified Test Circuit		70		ns
Fall Time	$t_f$	See specified Test Circuit		30		ns
Diode Forward Voltage	$V_{SD}$	$I_S = -1A, V_{GS} = 0$		-0.9		V
[SBD]						
Reverse Voltage	$V_R$	$I_R = 300\mu A$	30			V
Forward Voltage	$V_F$	$I_F = 700mA$			0.55	V
Reverse Current	$I_R$	$V_R = 15V$			80	$\mu A$
Interterminal Capacitance	$C$	$V_R = 10V, f = 1MHz$ Cycle		26		pF
Reverse Recovery Time	$t_{rr}$	$I_F = I_R = 100mA$ , See specified Test Circuit			10	ns
Thermal Resistance	$R_{th-a}$	Mounted on ceramic board (750mm <sup>2</sup> ×0.8mm)		100		°C/W

### Switching Time Test Circuit [MOSFET]

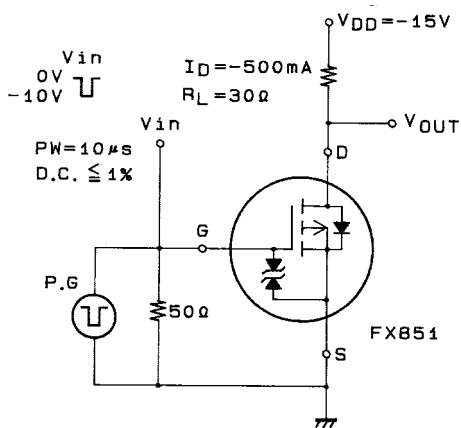

### Trr Test Circuit [SBD]

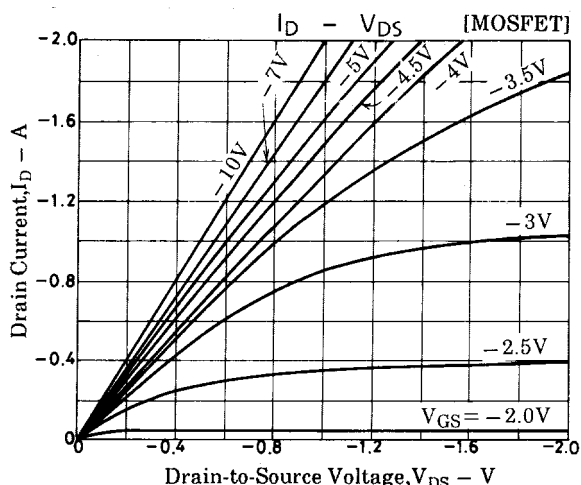
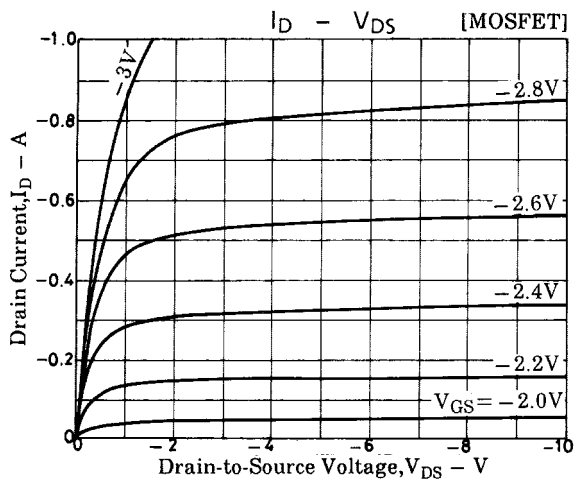
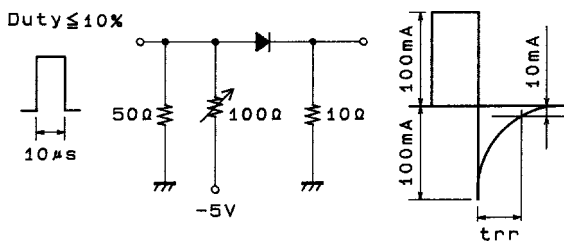

# FX851

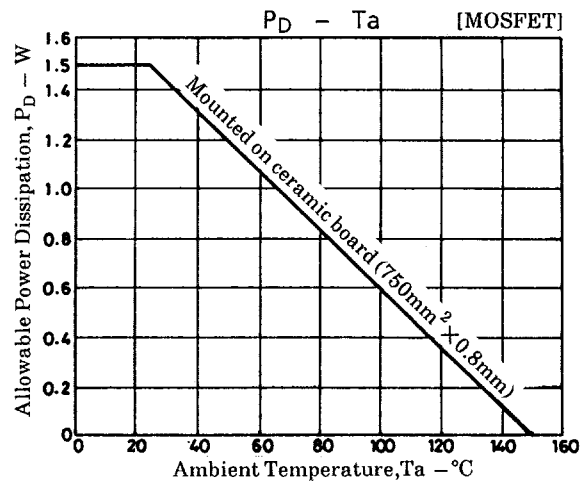
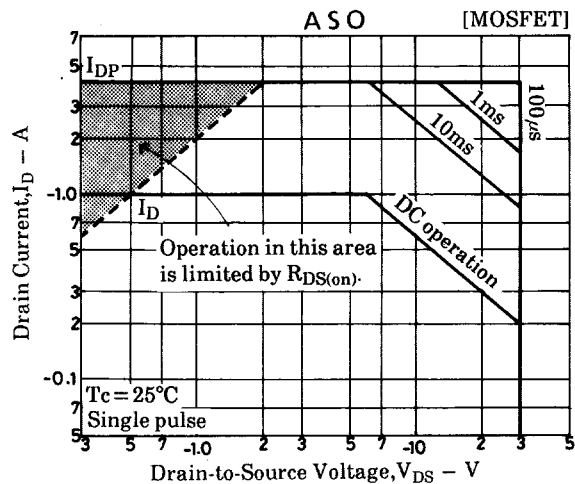
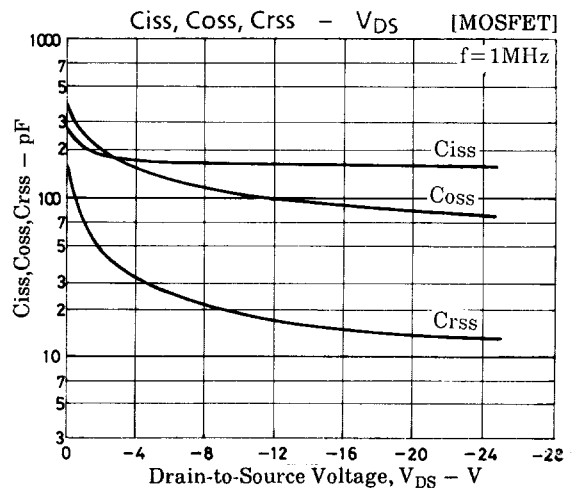
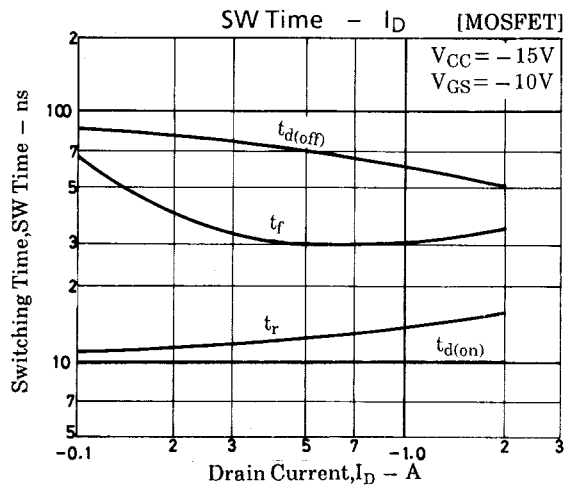
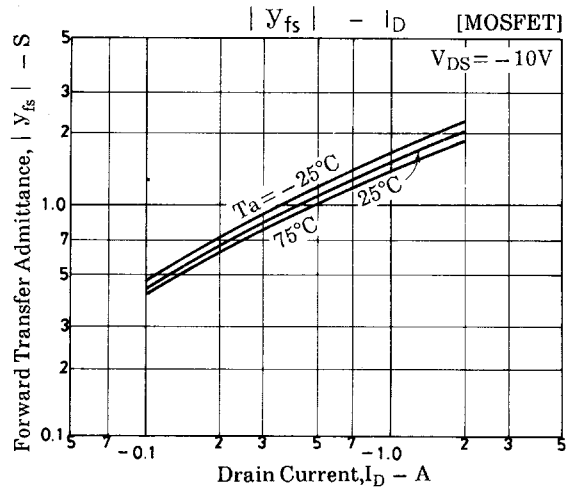
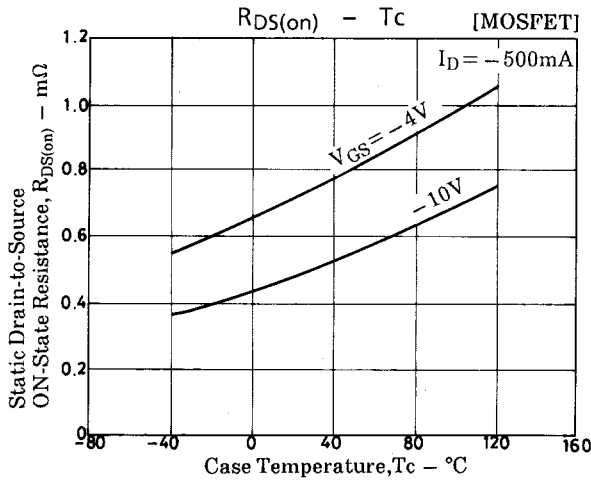
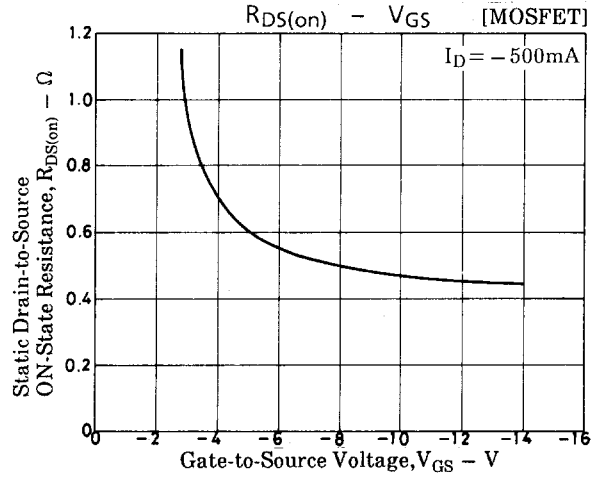
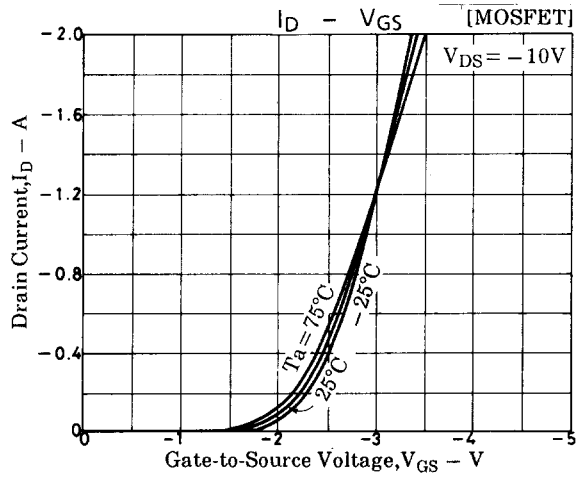

# FX851

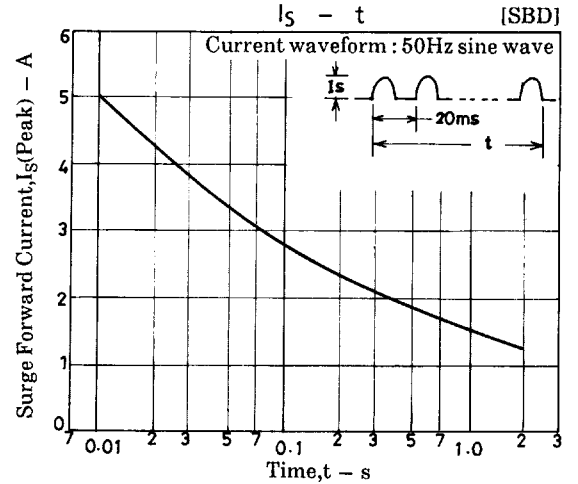
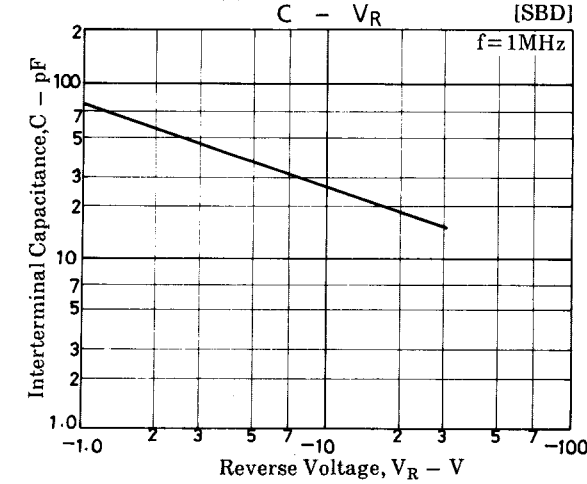
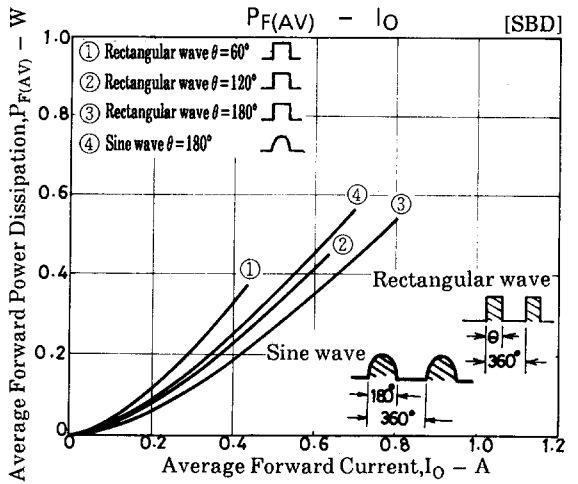
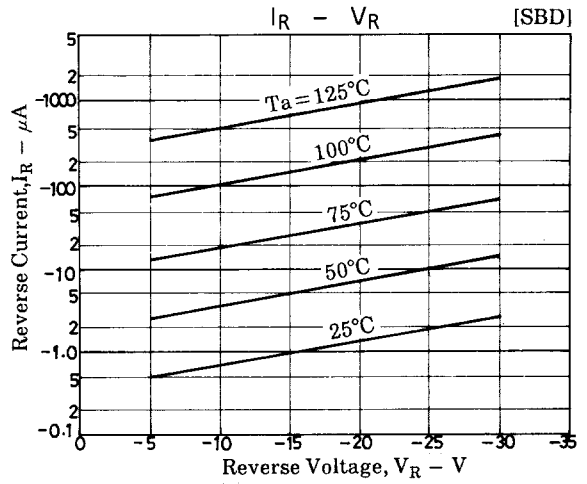
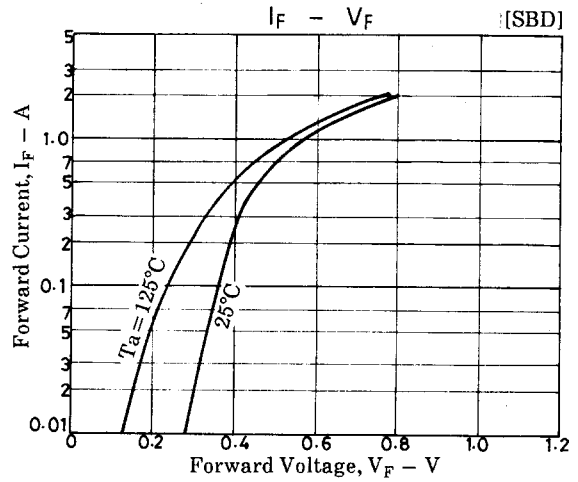
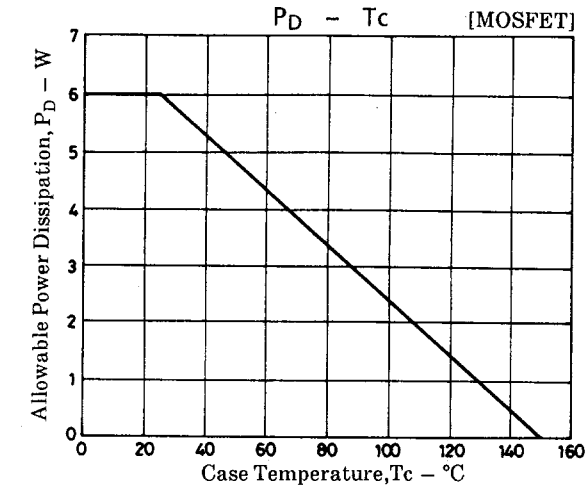

■ No products described or contained herein are intended for use in surgical implants, life-support systems, aerospace equipment, nuclear power control systems, vehicles, disaster/crime-prevention equipment and the like, the failure of which may directly or indirectly cause injury, death or property loss.

■ Anyone purchasing any products described or contained herein for an above-mentioned use shall:

- ① Accept full responsibility and indemnify and defend SANYO ELECTRIC CO., LTD., its affiliates, subsidiaries and distributors and all their officers and employees, jointly and severally, against any and all claims and litigation and all damages, cost and expenses associated with such use:
- ② Not impose any responsibility for any fault or negligence which may be cited in any such claim or litigation on SANYO ELECTRIC CO., LTD., its affiliates, subsidiaries and distributors or any of their officers and employees jointly or severally.

■ Information (including circuit diagrams and circuit parameters) herein is for example only; it is not guaranteed for volume production. SANYO believes information herein is accurate and reliable, but no guarantees are made or implied regarding its use or any infringements of intellectual property rights or other rights of third parties.

This catalog provides information as of May, 1998. Specifications and information herein are subject to change without notice.