

N - CHANNEL ENHANCEMENT MODE POWER MOS TRANSISTORS

TYPE	V _{DSS}	R _{DS(on)}	I _D [■]
IRF540	100 V	0.077 Ω	28 A
IRF540FI	100 V	0.077 Ω	15 A
IRF541	80 V	0.077 Ω	28 A
IRF541FI	80 V	0.077 Ω	15 A
IRF542	100 V	0.100 Ω	25 A
IRF542FI	100 V	0.100 Ω	14 A
IRF543	80 V	0.100 Ω	25 A
IRF543FI	80 V	0.100 Ω	14 A

- 80-100 VOLTS - FOR DC/DC CONVERTERS
- HIGH CURRENT
- ULTRA FAST SWITCHING
- EASY DRIVE- FOR REDUCED COST AND SIZE

INDUSTRIAL APPLICATIONS:

- UNINTERRUPTIBLE POWER SUPPLIES
- MOTOR CONTROLS

N - channel enhancement mode POWER MOS field effect transistors. Easy drive and very fast switching times make these POWER MOS transistors ideal for high speed switching applications. Applications include DC/DC converters, UPS, battery chargers, secondary regulators, servo control, power-audio amplifiers and robotics.

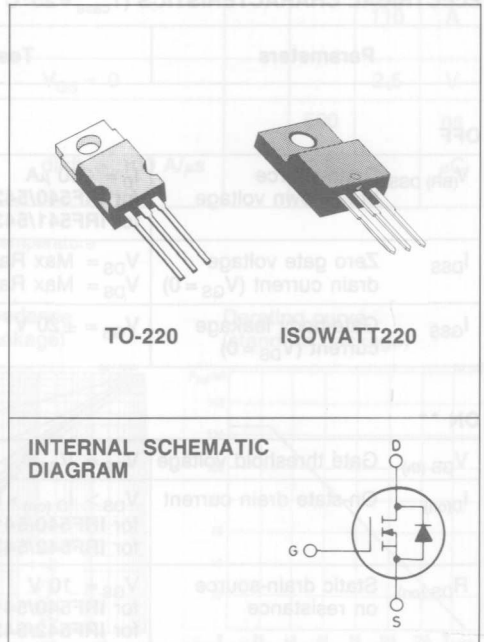

ABSOLUTE MAXIMUM RATINGS

		IRF					
		TO-220 ISOWATT220	540 540FI	541 541FI	542 542FI		543 543FI
V _{DS} *	Drain-source voltage (V _{GS} = 0)		100	80	100	80	V
V _{DGR} *	Drain-gate voltage (R _{GS} = 20 KΩ)		100	80	100	80	V
V _{GS}	Gate-source voltage				± 20		V
I _{DM} (●)	Drain current (pulsed)		110	110	100	100	A
I _{DLM}	Drain inductive current, clamped (L = 100 μH)		110	110	100	100	A
I _D	Drain current (cont.) at T _c = 25°C		28	28	25	25	A
I _D	Drain current (cont.) at T _c = 100°C		20	20	17	17	A
I _D [■]	Drain current (cont.) at T _c = 25°C		15	15	14	14	A
I _D [■]	Drain current (cont.) at T _c = 100°C		9	9	8	8	A
P _{tot} [■]	Total dissipation at T _c < 25°C		125		40		W
■	Derating factor		1		0.32		W/°C
T _{stg}	Storage temperature			-55 to 150			°C
T _j	Max. operating junction temperature			150			°C

* T_j = 25°C to 125°C

(●) Repetitive Rating: Pulse width limited by max junction temperature.

■ See note on ISOWATT220 on this datasheet.

THERMAL DATA *
TO-220 | ISOWATT220

$R_{thj-case}$	Thermal resistance junction-case	max	1	3.12	°C/W
$R_{thc-sink}$	Thermal resistance case-sink	typ	0.5		°C/W
$R_{thj-amb}$	Thermal resistance junction-ambient	max	80		°C/W
T_l	Maximum lead temperature for soldering purpose		300		°C

ELECTRICAL CHARACTERISTICS ($T_{case} = 25^\circ\text{C}$ unless otherwise specified)

Parameters	Test Conditions	Min.	Typ.	Max.	Unit
------------	-----------------	------	------	------	------

OFF

$V_{(BR)DSS}$	Drain-source breakdown voltage	$I_D = 250 \mu\text{A}$ for IRF540/542/540FI/542FI for IRF541/543/541FI/543FI	$V_{GS} = 0$	100 80	V V
I_{DSS}	Zero gate voltage drain current ($V_{GS} = 0$)	$V_{DS} = \text{Max Rating}$ $V_{DS} = \text{Max Rating} \times 0.8$	$T_c = 125^\circ\text{C}$		250 1000 μA μA
I_{GSS}	Gate-body leakage current ($V_{DS} = 0$)	$V_{GS} = \pm 20 \text{ V}$			± 500 nA

ON **

$V_{GS(th)}$	Gate threshold voltage	$V_{DS} = V_{GS}$	$I_D = 250 \mu\text{A}$	2	4	V
$I_{D(on)}$	On-state drain current	$V_{DS} > I_{D(on)} \times R_{DS(on)max}$	$V_{GS} = 10 \text{ V}$ for IRF540/541/540FI/541FI for IRF542/543/542FI/543FI	28 25		A A
$R_{DS(on)}$	Static drain-source on resistance	$V_{GS} = 10 \text{ V}$ for IRF540/541/540FI/541FI for IRF542/543/542FI/543FI	$I_D = 17 \text{ A}$		0.077 0.100	Ω Ω

DYNAMIC

g_{fs}^{**}	Forward transconductance	$V_{DS} > I_{D(on)} \times R_{DS(on)max}$ $I_D = 17 \text{ A}$		8.7		mho
C_{iss}	Input capacitance	$V_{DS} = 25 \text{ V}$ $V_{GS} = 0$	$f = 1 \text{ MHz}$		1600	pF
C_{oss}	Output capacitance				800	pF
C_{riss}	Reverse transfer capacitance				300	pF

SWITCHING

$t_{d(on)}$	Turn-on time	$V_{DD} = 30 \text{ V}$	$I_D = 15 \text{ A}$		30	ns
t_r	Rise time	$R_l = 4.7 \Omega$			60	ns
$t_{d(off)}$	Turn-off delay time	(see test circuit)			80	ns
t_f	Fall time				30	ns
Q_g	Total Gate Charge	$V_{GS} = 10 \text{ V}$ $V_{DS} = \text{Max Rating} \times 0.8$	$I_D = 28 \text{ A}$		59	nC
		(see test circuit)				

ELECTRICAL CHARACTERISTICS (Continued)

Parameters	Test Conditions	Min.	Typ.	Max.	Unit
------------	-----------------	------	------	------	------

SOURCE DRAIN DIODE

I_{SD}	Source-drain current			28	A
$I_{SDM}^{(*)}$	Source-drain current (pulsed)			110	A
V_{SD}^{**}	Forward on voltage	$I_{SD} = 28\text{ A}$	$V_{GS} = 0$	2.5	V
t_{rr}	Reverse recovery time	$T_J = 150^\circ\text{C}$		500	ns
Q_{rr}	Reverse recovered charge	$I_{SD} = 28\text{ A}$	$di/dt = 100\text{ A}/\mu\text{s}$	2.9	μC

** Pulsed: Pulse duration $\leq 300\ \mu\text{s}$, duty cycle $\leq 1.5\%$

(*) Repetitive Rating: Pulse width limited by max junction temperature

See note on ISOWATT220 in this datasheet

Safe operating areas (standard package)

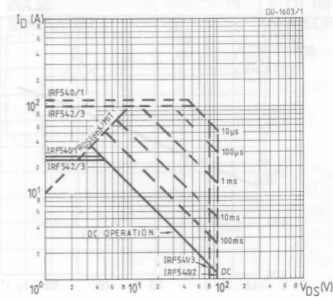

Thermal impedance (standard package)

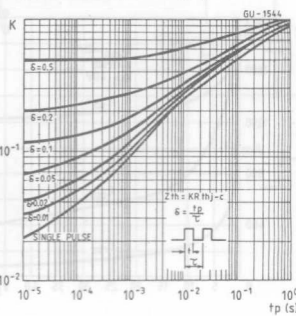

Derating curve (standard package)

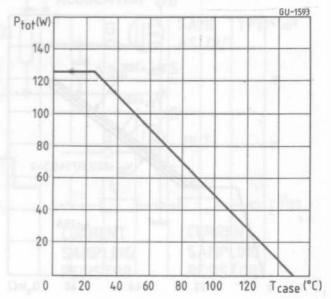

Output characteristics

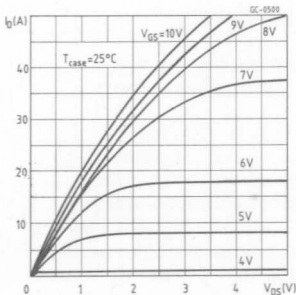

Output characteristics

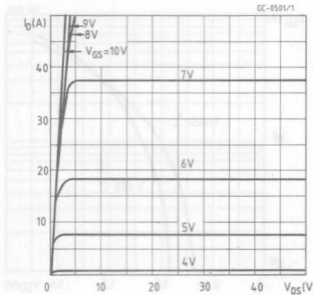

Transfer characteristics

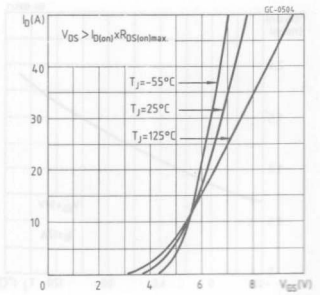

Transconductance

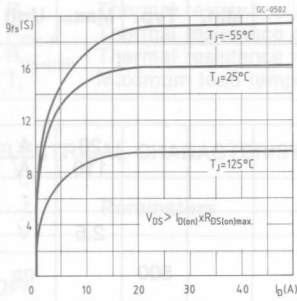

Static drain-source on resistance

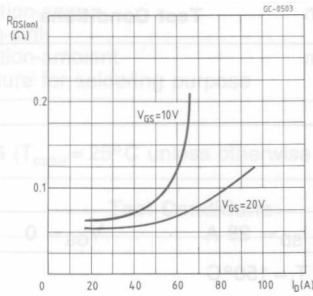

Maximum drain current vs temperature

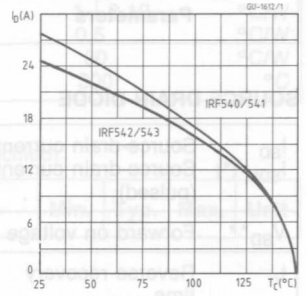

Gate charge vs gate-source voltage

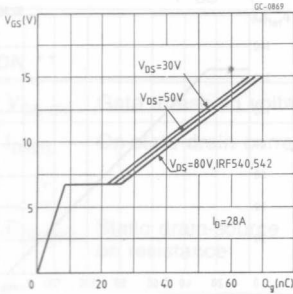

Capacitance variation

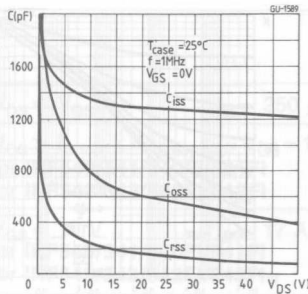

Normalized breakdown voltage vs temperature

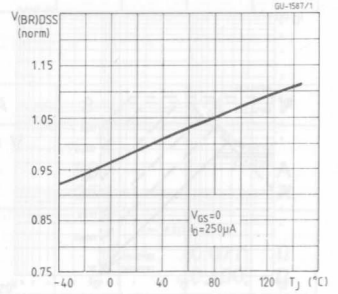

Normalized on resistance vs temperature

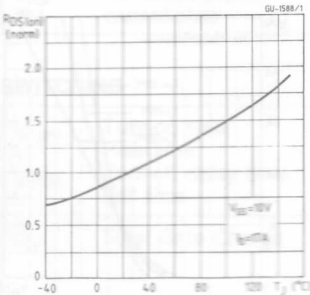

Source-drain diode forward characteristics

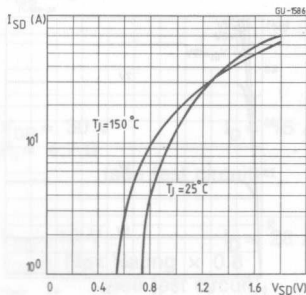

Clamped inductive test circuit

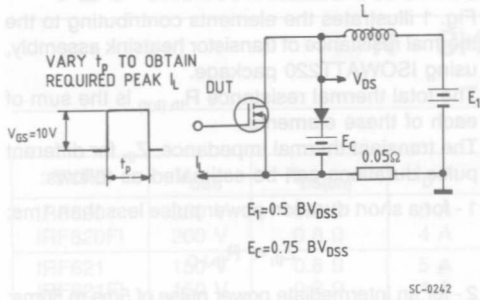

Clamped inductive waveforms

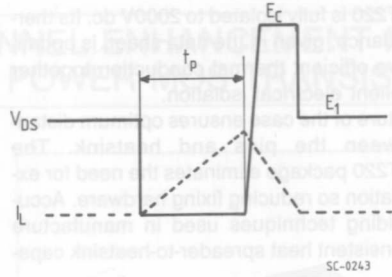

Switching times test circuit

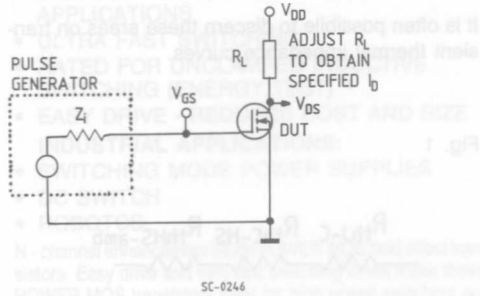

Gate charge test circuit

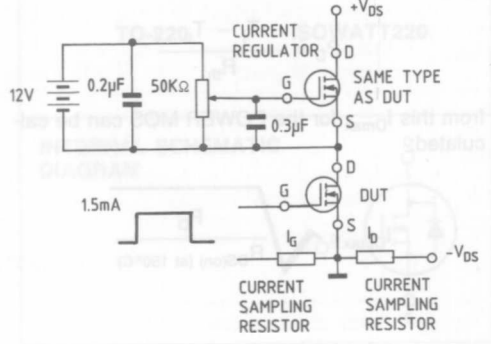

ABSOLUTE MAXIMUM RATINGS		IRF			
		TS-23P	620	621	623
		IRF540/FI	622FI	623FI	623FI
V_{DS}	Drain-source voltage (V)	200	150	200	150
V_{GS}	Drain-gate voltage ($R_{GS} = 10k\Omega$) (V)	200	150	200	150
V_{GS}	Gate-source voltage (V)	20	20	20	20
T_{DM} (*)	Drain mounting temperature (°C)	25	25	25	25
I_D	Drain current (cont.) (A)	3	3	4	4
I_{DM}	Drain current (cont.) at 100°C (A)	3	3	4	4
I_{DM}	Drain current (cont.) at 100°C (A)	3	3	4	4
P_{tot}	Total dissipation (W)	2.5	2.5	2.5	2.5
T_c	Case temperature (°C)	40	40	40	40
T_j	Junction temperature (°C)	0.3	0.3	0.3	0.3
T_{stg}	Storage temperature (°C)	-55 to 150	-55 to 150	-55 to 150	-55 to 150
T_{max}	Max. operating junction temperature (°C)	150	150	150	150

ISOWATT220 PACKAGE CHARACTERISTICS AND APPLICATION.

ISOWATT220 is fully isolated to 2000V dc. Its thermal impedance, given in the data sheet, is optimised to give efficient thermal conduction together with excellent electrical isolation.

The structure of the case ensures optimum distances between the pins and heatsink. The ISOWATT220 package eliminates the need for external isolation so reducing fixing hardware. Accurate moulding techniques used in manufacture assure consistent heat spreader-to-heatsink capacitance.

ISOWATT220 thermal performance is better than that of the standard part, mounted with a 0.1mm mica washer. The thermally conductive plastic has a higher breakdown rating and is less fragile than mica or plastic sheets. Power derating for ISOWATT220 packages is determined by:

$$P_D = \frac{T_j - T_c}{R_{th}}$$

from this I_{Dmax} for the POWER MOS can be calculated:

$$I_{Dmax} \leq \sqrt{\frac{P_D}{R_{DS(on)} \text{ (at } 150^\circ\text{C)}}$$

THERMAL IMPEDANCE OF ISOWATT220 PACKAGE

Fig. 1 illustrates the elements contributing to the thermal resistance of transistor heatsink assembly, using ISOWATT220 package.

The total thermal resistance $R_{th (tot)}$ is the sum of each of these elements.

The transient thermal impedance, Z_{th} for different pulse durations can be estimated as follows:

1 - for a short duration power pulse less than 1ms;

$$Z_{th} < R_{thJ-C}$$

2 - for an intermediate power pulse of 5ms to 50ms:

$$Z_{th} = R_{thJ-C}$$

3 - for long power pulses of the order of 500ms or greater:

$$Z_{th} = R_{thJ-C} + R_{thC-HS} + R_{thHS-amb}$$

It is often possible to discern these areas on transient thermal impedance curves.

Fig. 1

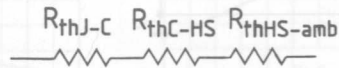

ISOWATT DATA

Safe operating areas

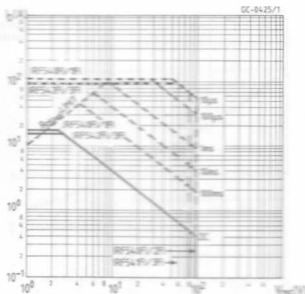

Thermal impedance characteristics

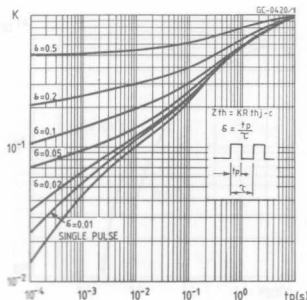

Derating curve

