

## N - CHANNEL ENHANCEMENT MODE POWER MOS TRANSISTORS

TYPE	V <sub>DSS</sub>	R <sub>DS(on)</sub>	I <sub>D</sub> <sup>■</sup>
IRF540	100 V	0.077 Ω	28 A
IRF540FI	100 V	0.077 Ω	15 A
IRF541	80 V	0.077 Ω	28 A
IRF541FI	80 V	0.077 Ω	15 A
IRF542	100 V	0.100 Ω	25 A
IRF542FI	100 V	0.100 Ω	14 A
IRF543	80 V	0.100 Ω	25 A
IRF543FI	80 V	0.100 Ω	14 A

- 80-100 VOLTS - FOR DC/DC CONVERTERS
- HIGH CURRENT
- ULTRA FAST SWITCHING
- EASY DRIVE- FOR REDUCED COST AND SIZE

### INDUSTRIAL APPLICATIONS:

- UNINTERRUPTIBLE POWER SUPPLIES
- MOTOR CONTROLS

N - channel enhancement mode POWER MOS field effect transistors. Easy drive and very fast switching times make these POWER MOS transistors ideal for high speed switching applications. Applications include DC/DC converters, UPS, battery chargers, secondary regulators, servo control, power-audio amplifiers and robotics.

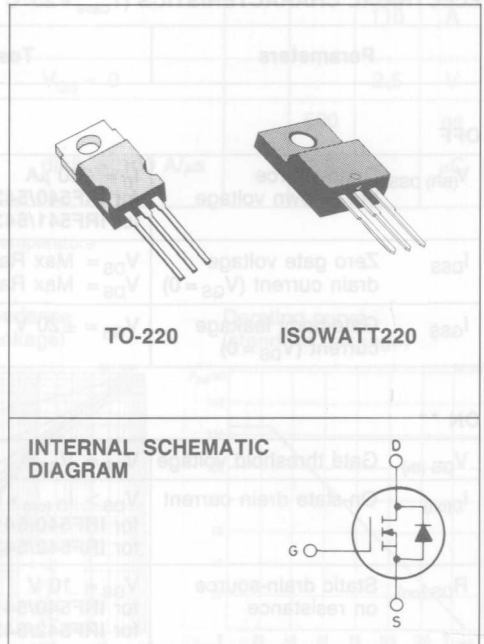

### ABSOLUTE MAXIMUM RATINGS

		IRF					
		TO-220 ISOWATT220	540 540FI	541 541FI	542 542FI		543 543FI
V <sub>DS</sub> *	Drain-source voltage (V <sub>GS</sub> = 0)		100	80	100	80	V
V <sub>DGR</sub> *	Drain-gate voltage (R <sub>GS</sub> = 20 KΩ)		100	80	100	80	V
V <sub>GS</sub>	Gate-source voltage				± 20		V
I <sub>DM</sub> (●)	Drain current (pulsed)		110	110	100	100	A
I <sub>DLM</sub>	Drain inductive current, clamped (L = 100 μH)		110	110	100	100	A
I <sub>D</sub>	Drain current (cont.) at T <sub>c</sub> = 25°C		28	28	25	25	A
I <sub>D</sub>	Drain current (cont.) at T <sub>c</sub> = 100°C		20	20	17	17	A
I <sub>D</sub> <sup>■</sup>	Drain current (cont.) at T <sub>c</sub> = 25°C		15	15	14	14	A
I <sub>D</sub> <sup>■</sup>	Drain current (cont.) at T <sub>c</sub> = 100°C		9	9	8	8	A
P <sub>tot</sub> <sup>■</sup>	Total dissipation at T <sub>c</sub> < 25°C		125		40		W
■	Derating factor		1		0.32		W/°C
T <sub>stg</sub>	Storage temperature			-55 to 150			°C
T <sub>j</sub>	Max. operating junction temperature			150			°C

\* T<sub>j</sub> = 25°C to 125°C

(●) Repetitive Rating: Pulse width limited by max junction temperature.

■ See note on ISOWATT220 on this datasheet.

**THERMAL DATA \***

TO-220 | ISOWATT220

$R_{thj-case}$	Thermal resistance junction-case	max	1	3.12	°C/W
$R_{thc-sink}$	Thermal resistance case-sink	typ	0.5		°C/W
$R_{thj-amb}$	Thermal resistance junction-ambient	max	80		°C/W
$T_l$	Maximum lead temperature for soldering purpose		300		°C

**ELECTRICAL CHARACTERISTICS** ( $T_{case} = 25^\circ\text{C}$  unless otherwise specified)

Parameters	Test Conditions	Min.	Typ.	Max.	Unit
------------	-----------------	------	------	------	------

**OFF**

$V_{(BR)DSS}$	Drain-source breakdown voltage	$I_D = 250 \mu\text{A}$ for <b>IRF540/542/540FI/542FI</b> for <b>IRF541/543/541FI/543FI</b>	$V_{GS} = 0$	100 80	V V
$I_{DSS}$	Zero gate voltage drain current ( $V_{GS} = 0$ )	$V_{DS} = \text{Max Rating}$ $V_{DS} = \text{Max Rating} \times 0.8$	$T_c = 125^\circ\text{C}$		250 1000 $\mu\text{A}$ $\mu\text{A}$
$I_{GSS}$	Gate-body leakage current ( $V_{DS} = 0$ )	$V_{GS} = \pm 20 \text{ V}$			$\pm 500$ nA

**ON \*\***

$V_{GS(th)}$	Gate threshold voltage	$V_{DS} = V_{GS}$	$I_D = 250 \mu\text{A}$	2	4	V
$I_{D(on)}$	On-state drain current	$V_{DS} > I_{D(on)} \times R_{DS(on)max}$	$V_{GS} = 10 \text{ V}$ for <b>IRF540/541/540FI/541FI</b> for <b>IRF542/543/542FI/543FI</b>	28 25		A A
$R_{DS(on)}$	Static drain-source on resistance	$V_{GS} = 10 \text{ V}$ for <b>IRF540/541/540FI/541FI</b> for <b>IRF542/543/542FI/543FI</b>	$I_D = 17 \text{ A}$		0.077 0.100	$\Omega$ $\Omega$

**DYNAMIC**

$g_{fs}^{**}$	Forward transconductance	$V_{DS} > I_{D(on)} \times R_{DS(on)max}$ $I_D = 17 \text{ A}$		8.7		mho
$C_{iss}$	Input capacitance				1600	pF
$C_{oss}$	Output capacitance	$V_{DS} = 25 \text{ V}$	$f = 1 \text{ MHz}$		800	pF
$C_{riss}$	Reverse transfer capacitance	$V_{GS} = 0$			300	pF

**SWITCHING**

$t_{d(on)}$	Turn-on time	$V_{DD} = 30 \text{ V}$	$I_D = 15 \text{ A}$		30	ns
$t_r$	Rise time	$R_l = 4.7 \Omega$			60	ns
$t_{d(off)}$	Turn-off delay time		(see test circuit)		80	ns
$t_f$	Fall time				30	ns
$Q_g$	Total Gate Charge	$V_{GS} = 10 \text{ V}$ $V_{DS} = \text{Max Rating} \times 0.8$	$I_D = 28 \text{ A}$		59	nC
			(see test circuit)			

ELECTRICAL CHARACTERISTICS (Continued)

Parameters	Test Conditions	Min.	Typ.	Max.	Unit
------------	-----------------	------	------	------	------

SOURCE DRAIN DIODE

$I_{SD}$	Source-drain current			28	A
$I_{SDM}^{(*)}$	Source-drain current (pulsed)			110	A
$V_{SD}^{**}$	Forward on voltage	$I_{SD} = 28\text{ A}$	$V_{GS} = 0$	2.5	V
$t_{rr}$	Reverse recovery time	$T_j = 150^\circ\text{C}$		500	ns
$Q_{rr}$	Reverse recovered charge	$I_{SD} = 28\text{ A}$	$di/dt = 100\text{ A}/\mu\text{s}$	2.9	$\mu\text{C}$

\*\* Pulsed: Pulse duration  $\leq 300\ \mu\text{s}$ , duty cycle  $\leq 1.5\%$

(\*) Repetitive Rating: Pulse width limited by max junction temperature

See note on ISOWATT220 in this datasheet

Safe operating areas (standard package)

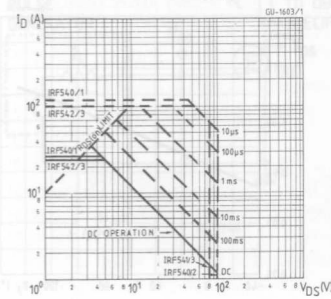

Thermal impedance (standard package)

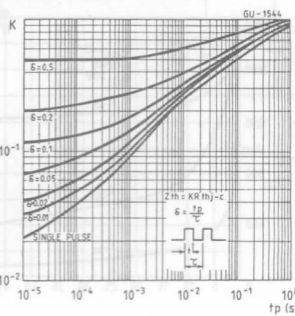

Derating curve (standard package)

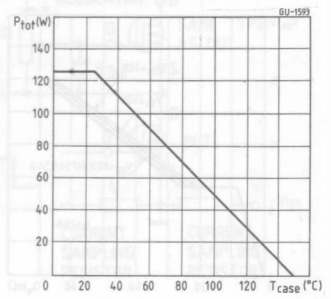

Output characteristics

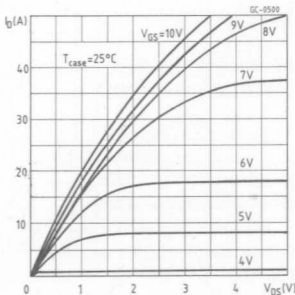

Output characteristics

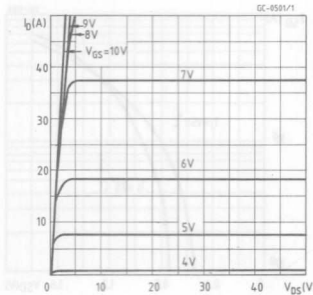

Transfer characteristics

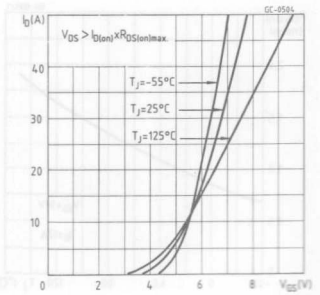

Transconductance

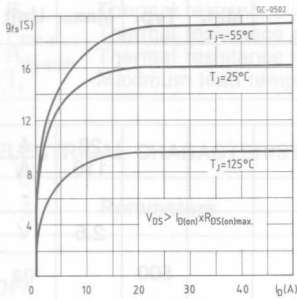

Static drain-source on resistance

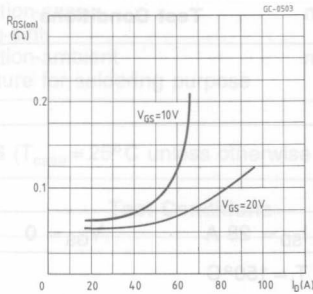

Maximum drain current vs temperature

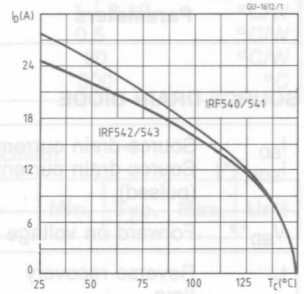

Gate charge vs gate-source voltage

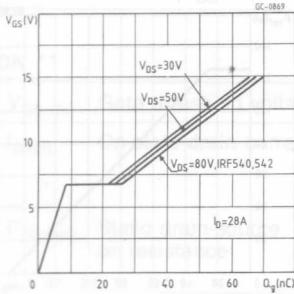

Capacitance variation

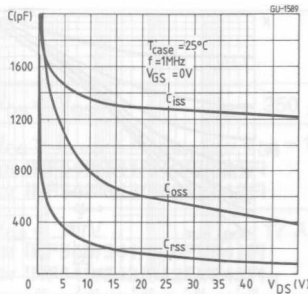

Normalized breakdown voltage vs temperature

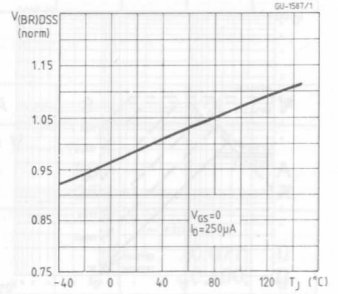

Normalized on resistance vs temperature

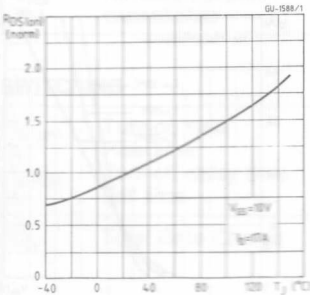

Source-drain diode forward characteristics

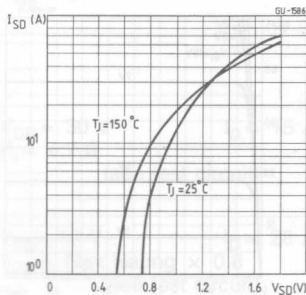

Clamped inductive test circuit

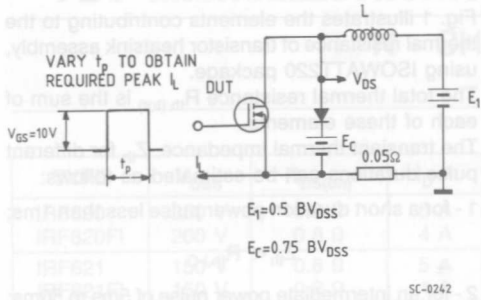

Clamped inductive waveforms

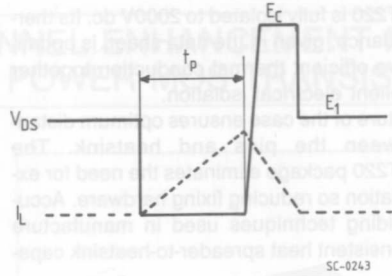

Switching times test circuit

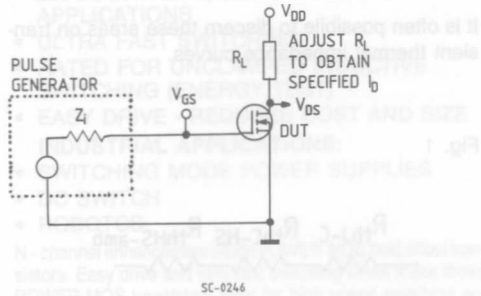

Gate charge test circuit

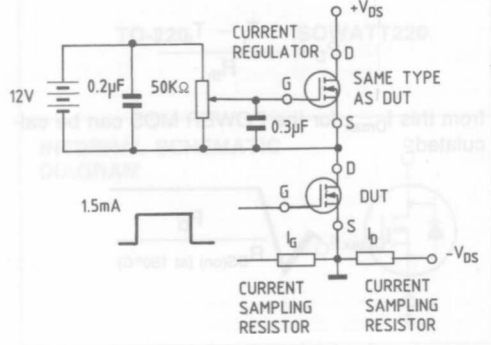

ABSOLUTE MAXIMUM RATINGS		IRF			
		540	541	542	543
		IRF540FI	IRF541FI	IRF542FI	IRF543FI
$V_{DS}$	Drain-source voltage (V)	200	150	200	150
$V_{GS}$	Drain-gate voltage ( $R_{GS}=50\Omega$ ) (V)	200	150	200	150
$V_{GS}$	Gate-source voltage (V)	20	20	20	20
$T_{DM}$ (*)	Drain mounting temperature (°C)	25	25	25	25
$T_{JM}$	Junction mounting temperature (°C)	25	25	25	25
$I_{DM}$	Drain current (continuous) (A)	3	3	4	4
$I_{DM}$	Drain current (pulse) (A)	3	3	4	4
$I_{DM}$	Drain current (short) (A)	3	3	4	4
$P_{TOT}$	Total dissipation (W)	2.5	2.5	2.5	2.5
$T_c$	Case temperature (°C)	40	40	40	40
$T_c$	Storage temperature (°C)	0.3	0.3	0.3	0.3
$T_c$	Max. operating junction temperature (°C)	150	150	150	150
*) Temperature Range: Power with limited duty cycle. See application note on this subject.					
Produced in 1988 under #44					

**ISOWATT220 PACKAGE CHARACTERISTICS AND APPLICATION.**

ISOWATT220 is fully isolated to 2000V dc. Its thermal impedance, given in the data sheet, is optimised to give efficient thermal conduction together with excellent electrical isolation.

The structure of the case ensures optimum distances between the pins and heatsink. The ISOWATT220 package eliminates the need for external isolation so reducing fixing hardware. Accurate moulding techniques used in manufacture assure consistent heat spreader-to-heatsink capacitance.

ISOWATT220 thermal performance is better than that of the standard part, mounted with a 0.1mm mica washer. The thermally conductive plastic has a higher breakdown rating and is less fragile than mica or plastic sheets. Power derating for ISOWATT220 packages is determined by:

$$P_D = \frac{T_j - T_c}{R_{th}}$$

from this  $I_{Dmax}$  for the POWER MOS can be calculated:

$$I_{Dmax} \leq \sqrt{\frac{P_D}{R_{DS(on)} \text{ (at } 150^\circ\text{C)}}$$

**THERMAL IMPEDANCE OF ISOWATT220 PACKAGE**

Fig. 1 illustrates the elements contributing to the thermal resistance of transistor heatsink assembly, using ISOWATT220 package.

The total thermal resistance  $R_{th (tot)}$  is the sum of each of these elements.

The transient thermal impedance,  $Z_{th}$  for different pulse durations can be estimated as follows:

1 - for a short duration power pulse less than 1ms;

$$Z_{th} < R_{thJ-C}$$

2 - for an intermediate power pulse of 5ms to 50ms:

$$Z_{th} = R_{thJ-C}$$

3 - for long power pulses of the order of 500ms or greater:

$$Z_{th} = R_{thJ-C} + R_{thC-HS} + R_{thHS-amb}$$

It is often possible to discern these areas on transient thermal impedance curves.

Fig. 1

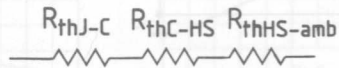

**ISOWATT DATA**

**Safe operating areas**

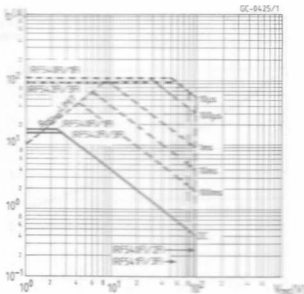

**Thermal impedance characteristics**

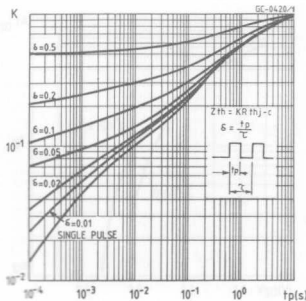

**Derating curve**

