

N - CHANNEL ENHANCEMENT MODE POWER MOS TRANSISTORS

TYPE	V _{DSS}	R _{DS(on)}	I _D [■]
IRF730	400 V	1.0 Ω	5.5 A
IRF730FI	400 V	1.0 Ω	3.5 A
IRF731	350 V	1.0 Ω	5.5 A
IRF731FI	350 V	1.0 Ω	3.5 A
IRF732	400 V	1.5 Ω	4.5 A
IRF732FI	400 V	1.5 Ω	3.0 A
IRF733	350 V	1.5 Ω	4.5 A
IRF733FI	350 V	1.5 Ω	3.0 A

- HIGH VOLTAGE - FOR ELECTRONIC LAMP BALLAST
- ULTRA FAST SWITCHING
- EASY DRIVE - FOR REDUCED COST AND SIZE

INDUSTRIAL APPLICATIONS:

- ELECTRONIC LAMP BALLAST
- DC SWITCH

N - channel enhancement mode POWER MOS field effect transistors. Easy drive and very fast switching times make these POWER MOS transistors ideal for high speed switching applications. Applications include DC switch, constant current source, ultrasonic equipment and electronic ballast for fluorescent lamps.

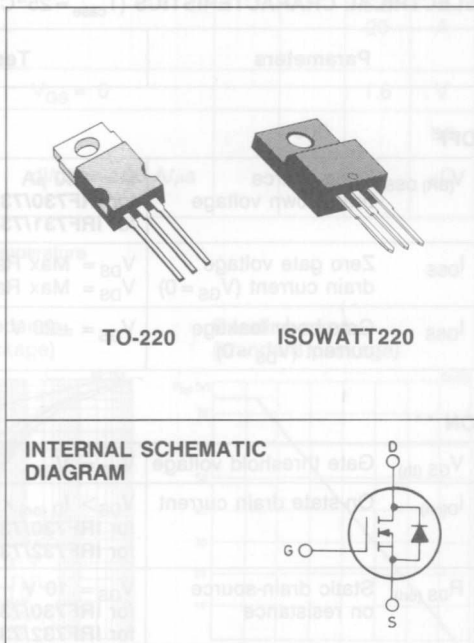

ABSOLUTE MAXIMUM RATINGS

		TO-220 ISOWATT220	IRF				
			730 730FI	731 731FI	732 732FI	733 733FI	
V _{DS} *	Drain-source voltage (V _{GS} = 0)		400	350	400	350	V
V _{DGR} *	Drain-gate voltage (R _{GS} = 20 KΩ)		400	350	400	350	V
V _{GS}	Gate-source voltage		±20				V
I _{DM} (*)	Drain current (pulsed)		20	20	16	16	A
I _{DLM}	Drain inductive current, clamped (L = 100 μH)		20	20	16	16	A
I _D	Drain current (cont.) at T _c = 25°C		5.5	5.5	4.5	4.5	A
I _D	Drain current (cont.) at T _c = 100°C		3.5	3.5	3	3	A
I _D [■]	Drain current (cont.) at T _c = 25°C		730FI	731FI	732FI	733FI	A
I _D [■]	Drain current (cont.) at T _c = 100°C		2	2	1.8	1.8	A
P _{tot} [■]	Total dissipation at T _c < 25°C		TO-220		ISOWATT220		W
	Derating factor		74		35		
T _{stg}	Storage temperature		0.59		0.28		W/°C
T _J	Max. operating junction temperature		-55 to 150				°C
			150				°C

* T_c = 25°C to 125°C

(*) Repetitive Rating: Pulse width limited by max junction temperature.

■ See note on ISOWATT220 on this datasheet.

THERMAL DATA *

		TO-220		ISOWATT220	
$R_{thj-case}$	Thermal resistance junction-case	max	1.69	3.57	°C/W
R_{thc-s}	Thermal resistance case-sink	typ	0.5		°C/W
$R_{thj-amb}$	Thermal resistance junction-ambient	max	80		°C/W
T_l	Maximum lead temperature for soldering purpose		300		°C

ELECTRICAL CHARACTERISTICS ($T_{case} = 25^\circ\text{C}$ unless otherwise specified)

Parameters	Test Conditions	Min.	Typ.	Max.	Unit
------------	-----------------	------	------	------	------

OFF

$V_{(BR)DSS}$	Drain-source breakdown voltage	$I_D = 250 \mu\text{A}$ for IRF730/732/730FI/732FI for IRF731/733/731FI/733FI	$V_{GS} = 0$	400 350		V V
I_{DSS}	Zero gate voltage drain current ($V_{GS} = 0$)	$V_{DS} = \text{Max Rating}$ $V_{DS} = \text{Max Rating} \times 0.8$	$T_c = 125^\circ\text{C}$		250 1000	μA μA
I_{GSS}	Gate-body leakage current ($V_{DS} = 0$)	$V_{GS} = \pm 20 \text{ V}$			± 500	nA

ON **

$V_{GS(th)}$	Gate threshold voltage	$V_{DS} = V_{GS}$	$I_D = 250 \mu\text{A}$	2		4 V
$I_{D(on)}$	On-state drain current	$V_{DS} > I_{D(on)} \times R_{DS(on)max}$	$V_{GS} = 10 \text{ V}$ for IRF730/731/730FI/731FI for IRF732/733/732FI/733FI	5.5 4.5		A A
$R_{DS(on)}$	Static drain-source on resistance	$V_{GS} = 10 \text{ V}$ for IRF730/731/730FI/731FI for IRF732/733/732FI/733FI	$I_D = 3.0 \text{ A}$		1.0 1.5	Ω Ω

DYNAMIC

g_{fs}^{**}	Forward transconductance	$V_{DS} > I_{D(on)} \times R_{DS(on)max}$ $I_D = 3.0 \text{ A}$		2.9		mho
C_{iss}	Input capacitance	$V_{DS} = 25 \text{ V}$ $V_{GS} = 0$	$f = 1 \text{ MHz}$		800	pF
C_{oss}	Output capacitance				300	pF
C_{rss}	Reverse transfer capacitance				80	pF

SWITCHING

$t_{d(on)}$	Turn-on time	$V_{DD} = 175 \text{ V}$ $R_l = 15 \Omega$ (see test circuit)	$I_D = 3.0 \text{ A}$		30	ns
t_r	Rise time				35	ns
$t_{d(off)}$	Turn-off delay time				55	ns
t_f	Fall time				35	ns
Q_g	Total Gate Charge			$V_{GS} = 10 \text{ V}$ $V_{DS} = \text{Max Rating} \times 0.8$ (see test circuit)	$I_D = 5.5 \text{ A}$	

ELECTRICAL CHARACTERISTICS (Continued)

Parameters		Test Conditions		Min.	Typ.	Max.	Unit
I_{SD}	Source-drain current					5.5	A
$I_{SDM} (*)$	Source-drain current (pulsed)					20	A
V_{SD}	Forward on voltage	$I_{SD} = 5.5 \text{ A}$	$V_{GS} = 0$			1.6	V
t_{rr}	Reverse recovery time	$T_j = 150^\circ\text{C}$			600		ns
Q_{rr}	Reverse recovered charge	$I_{SD} = 5.5 \text{ A}$	$di/dt = 100 \text{ A}/\mu\text{s}$		4		μC

** Pulsed: Pulse duration $\leq 300 \mu\text{s}$, duty cycle $\leq 1.5\%$
 (*) Repetitive Rating: Pulse width limited by max junction temperature
 ■ See note on ISOWATT220 in this datasheet

Safe operating areas (standard package)

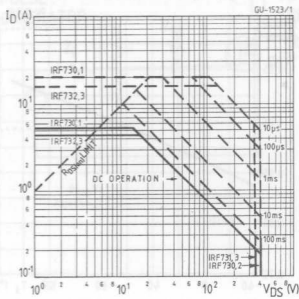

Thermal impedance (standard package)

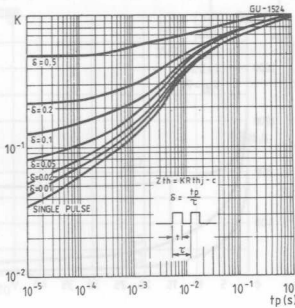

Derating curve (standard package)

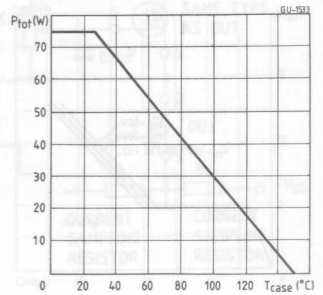

Output characteristics

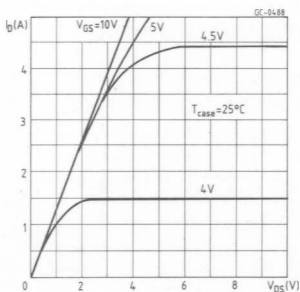

Output characteristics

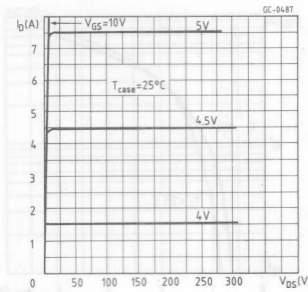

Transfer characteristics

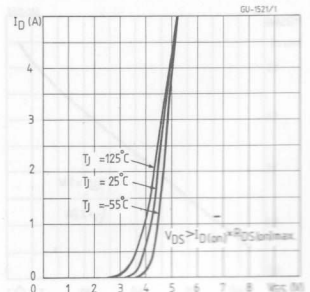

Transconductance

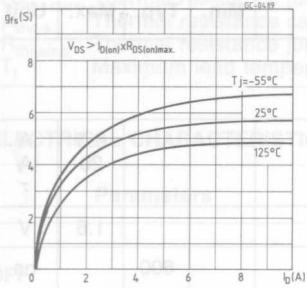

Static drain-source on resistance

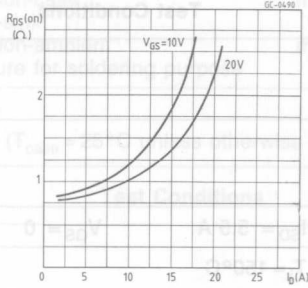

Maximum drain current vs temperature

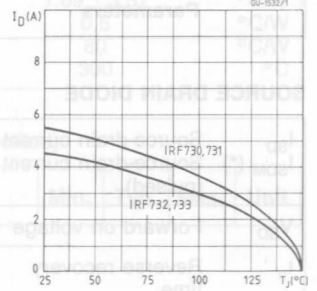

Gate charge vs gate-source voltage

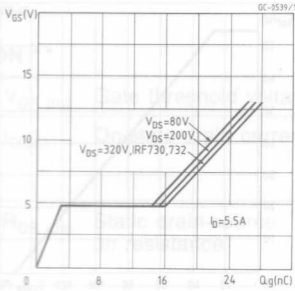

Capacitance variation

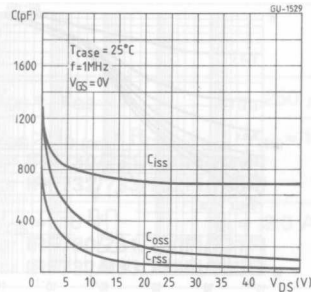

Normalized breakdown voltage vs temperature

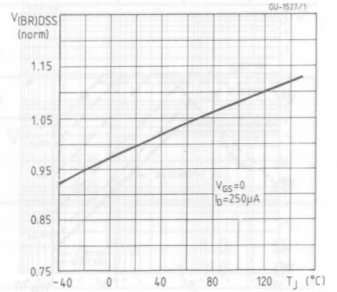

Normalized on resistance vs temperature

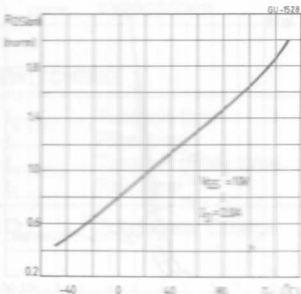

Source-drain diode forward characteristics

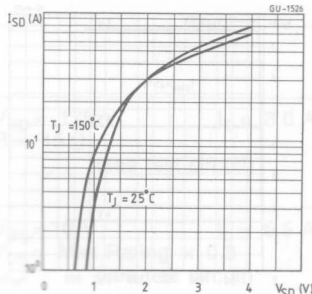

Clamped inductive test circuit

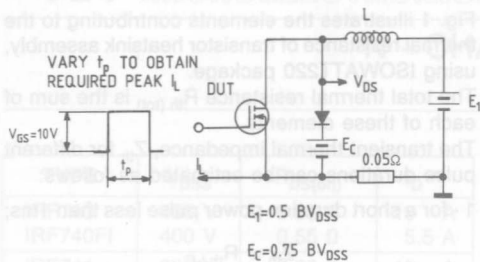

Clamped inductive waveforms

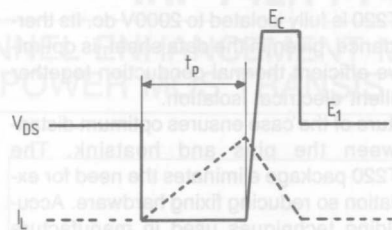

SC-0243

Switching times test circuit

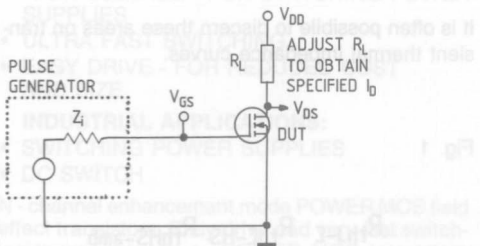

SC-0246

Gate charge test circuit

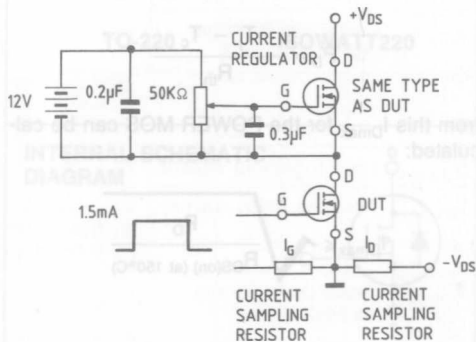

SC-0244

ABSOLUTE MAXIMUM RATINGS

V_{DS}	Drain-source voltage ($I_{DS} = 0$)
V_{GS}	Drain-gate voltage ($I_{DS} = 0$)
V_{GS}	Gate-source voltage
I_{DS}	Drain current (continuous)
I_{DM}	Drain inductive current ($\tau = 100 \mu s$)

TO-220
IRF730FI

IRF
740 741 742FI 743
740FI 741FI 742FI 743FI

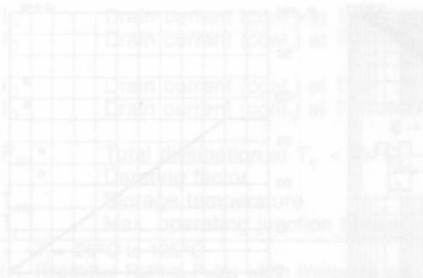

ISOWATT220 PACKAGE CHARACTERISTICS AND APPLICATION.

ISOWATT220 is fully isolated to 2000V dc. Its thermal impedance, given in the data sheet, is optimized to give efficient thermal conduction together with excellent electrical isolation.

The structure of the case ensures optimum distances between the pins and heatsink. The ISOWATT220 package eliminates the need for external isolation so reducing fixing hardware. Accurate moulding techniques used in manufacture assure consistent heat spreader-to-heatsink capacitance.

ISOWATT220 thermal performance is better than that of the standard part, mounted with a 0.1mm mica washer. The thermally conductive plastic has a higher breakdown rating and is less fragile than mica or plastic sheets. Power derating for ISOWATT220 packages is determined by:

$$P_D = \frac{T_j - T_c}{R_{th}}$$

from this I_{Dmax} for the POWER MOS can be calculated:

$$I_{Dmax} \leq \sqrt{\frac{P_D}{R_{DS(on)} \text{ (at } 150^\circ\text{C)}}}$$

THERMAL IMPEDANCE OF ISOWATT220 PACKAGE

Fig. 1 illustrates the elements contributing to the thermal resistance of transistor heatsink assembly, using ISOWATT220 package.

The total thermal resistance $R_{th(tot)}$ is the sum of each of these elements.

The transient thermal impedance, Z_{th} for different pulse durations can be estimated as follows:

1 - for a short duration power pulse less than 1ms;

$$Z_{th} < R_{thJ-C}$$

2 - for an intermediate power pulse of 5ms to 50ms:

$$Z_{th} = R_{thJ-C}$$

3 - for long power pulses of the order of 500ms or greater:

$$Z_{th} = R_{thJ-C} + R_{thC-HS} + R_{thHS-amb}$$

It is often possible to discern these areas on transient thermal impedance curves.

Fig. 1

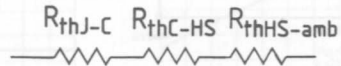

ISOWATT DATA

Safe operating areas

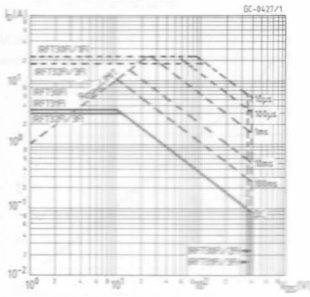

Thermal impedance

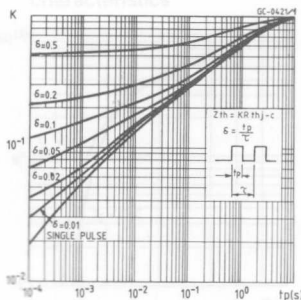

Derating curve

