

PRELIMINARY

# IRF7422D2

FETKY™ MOSFET & Schottky Diode

- Co-packaged HEXFET® Power MOSFET and Schottky Diode
- Ideal For Buck Regulator Applications
- P-Channel HEXFET
- Low  $V_F$  Schottky Rectifier
- Generation 5 Technology
- SO-8 Footprint

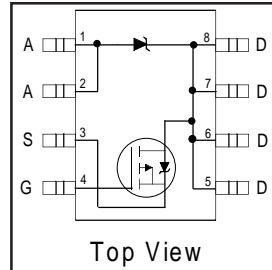

$V_{DSS} = -20V$
$R_{DS(on)} = 0.09\Omega$
Schottky $V_f = 0.52V$

## Description

The FETKY™ family of Co-packaged HEXFETs and Schottky diodes offer the designer an innovative board space saving solution for switching regulator and power management applications. Generation 5 HEXFETs utilize advanced processing techniques to achieve extremely low on-resistance per silicon area. Combining this technology with International Rectifier's low forward drop Schottky rectifiers results in an extremely efficient device suitable for use in a wide variety of portable electronics applications.

The SO-8 has been modified through a customized leadframe for enhanced thermal characteristics. The SO-8 package is designed for vapor phase, infrared or wave soldering techniques.

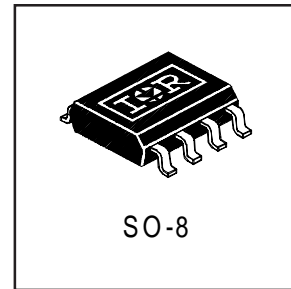

## Absolute Maximum Ratings

Parameter		Maximum	Units
$I_D @ T_A = 25^\circ C$	Continuous Drain Current, $V_{GS} @ -4.5V$	-4.3	A
$I_D @ T_A = 70^\circ C$		-3.4	
$I_{DM}$	Pulsed Drain Current ①	-33	
$P_D @ T_A = 25^\circ C$	Power Dissipation	2.0	W
$P_D @ T_A = 70^\circ C$		1.3	
	Linear Derating Factor	16	mW/°C
$V_{GS}$	Gate-to-Source Voltage	$\pm 12$	V
dv/dt	Peak Diode Recovery dv/dt ②	-5.0	V/ns
$T_J, T_{STG}$	Junction and Storage Temperature Range	-55 to +150	°C

## Thermal Resistance Ratings

Parameter		Maximum	Units
$R_{\theta JA}$	Junction-to-Ambient ④	62.5	°C/W

### Notes:

- ① Repetitive rating – pulse width limited by max. junction temperature (see fig. 11)
- ②  $I_{SD} \leq -2.2A$ ,  $di/dt \leq -50A/\mu s$ ,  $V_{DD} \leq V_{(BR)DSS}$ ,  $T_J \leq 150^\circ C$
- ③ Pulse width  $\leq 300\mu s$  – duty cycle  $\leq 2\%$
- ④ Surface mounted on FR-4 board,  $t \leq 10sec$ .

www.irf.com

**MOSFET Electrical Characteristics @ T<sub>J</sub> = 25°C (unless otherwise specified)**

	Parameter	Min.	Typ.	Max.	Units	Conditions
V <sub>(BR)DSS</sub>	Drain-to-Source Breakdown Voltage	-20	—	—	V	V <sub>GS</sub> = 0V, I <sub>D</sub> = -250μA
R <sub>DS(on)</sub>	Static Drain-to-Source On-Resistance	—	0.07	0.09	Ω	V <sub>GS</sub> = -4.5V, I <sub>D</sub> = -2.2A ③
		—	0.115	0.14		V <sub>GS</sub> = -2.7V, I <sub>D</sub> = -1.8A ③
V <sub>GS(th)</sub>	Gate Threshold Voltage	-0.70	—	—	V	V <sub>DS</sub> = V <sub>GS</sub> , I <sub>D</sub> = -250μA
g <sub>fs</sub>	Forward Transconductance	4.0	—	—	S	V <sub>DS</sub> = -16V, I <sub>D</sub> = -2.2A
I <sub>DSS</sub>	Drain-to-Source Leakage Current	—	—	-1.0	μA	V <sub>DS</sub> = -16V, V <sub>GS</sub> = 0V
		—	—	-25		V <sub>DS</sub> = -16V, V <sub>GS</sub> = 0V, T <sub>J</sub> = 125°C
I <sub>GSS</sub>	Gate-to-Source Forward Leakage	—	—	-100	nA	V <sub>GS</sub> = -12V
	Gate-to-Source Reverse Leakage	—	—	100		V <sub>GS</sub> = 12V
Q <sub>g</sub>	Total Gate Charge	—	15	22	nC	I <sub>D</sub> = -2.2A
Q <sub>gs</sub>	Gate-to-Source Charge	—	2.2	3.3		V <sub>DS</sub> = -16V
Q <sub>gd</sub>	Gate-to-Drain ("Miller") Charge	—	6.0	9.0		V <sub>GS</sub> = -4.5V, See Fig. 6 and 9 ③
t <sub>d(on)</sub>	Turn-On Delay Time	—	8.4	—		V <sub>DD</sub> = -10V
t <sub>r</sub>	Rise Time	—	26	—	ns	I <sub>D</sub> = -2.2A
t <sub>d(off)</sub>	Turn-Off Delay Time	—	51	—		R <sub>G</sub> = 6.0Ω
t <sub>f</sub>	Fall Time	—	33	—		R <sub>D</sub> = 4.5Ω, See Fig. 10 ③
C <sub>iss</sub>	Input Capacitance	—	610	—		V <sub>GS</sub> = 0V
C <sub>oss</sub>	Output Capacitance	—	310	—	pF	V <sub>DS</sub> = -15V
C <sub>rss</sub>	Reverse Transfer Capacitance	—	170	—		f = 1.0MHz, See Fig. 5

**MOSFET Source-Drain Ratings and Characteristics**

	Parameter	Min.	Typ.	Max.	Units	Conditions
I <sub>S</sub>	Continuous Source Current(Body Diode)	—	—	-2.5	A	
I <sub>SM</sub>	Pulsed Source Current (Body Diode)	—	—	-17		
V <sub>SD</sub>	Body Diode Forward Voltage	—	—	-1.0	V	T <sub>J</sub> = 25°C, I <sub>S</sub> = -1.8A, V <sub>GS</sub> = 0V
t <sub>rr</sub>	Reverse Recovery Time (Body Diode)	—	56	84	ns	T <sub>J</sub> = 25°C, I <sub>F</sub> = -2.2A
Q <sub>rr</sub>	Reverse Recovery Charge	—	71	110	nC	di/dt = -100A/μs ③

**Schottky Diode Maximum Ratings**

	Parameter	Max.	Units	Conditions
I <sub>f(av)</sub>	Max. Average Forward Current	2.8	A	50% Duty Cycle. Rectangular Wave, T <sub>c</sub> = 25°C
		1.8		50% Duty Cycle. Rectangular Wave, T <sub>c</sub> = 70°C
I <sub>SM</sub>	Max. peak one cycle Non-repetitive Surge current	200	A	5μs sine or 3μs Rect. pulse
		20		10ms sine or 6ms Rect. pulse
				Following any rated load condition & with V <sub>rrm</sub> applied

**Schottky Diode Electrical Specifications**

	Parameter	Max.	Units	Conditions
V <sub>fm</sub>	Max. Forward voltage drop	0.57	V	I <sub>f</sub> = 3.0, T <sub>J</sub> = 25°C
		0.77		I <sub>f</sub> = 6.0, T <sub>J</sub> = 25°C
		0.52		I <sub>f</sub> = 3.0, T <sub>J</sub> = 125°C
		0.79		I <sub>f</sub> = 6.0, T <sub>J</sub> = 125°C
I <sub>rm</sub>	Max. Reverse Leakage current	0.13	mA	V <sub>r</sub> = 20V, T <sub>J</sub> = 25°C
		18		T <sub>J</sub> = 125°C
C <sub>t</sub>	Max. Junction Capacitance	310	pF	V <sub>r</sub> = 5Vdc ( 100kHz to 1 MHz) 25°C
dv/dt	Max. Voltage Rate of Charge	4900	V/μs	Rated V <sub>r</sub>

( HEXFET is the reg. TM for International Rectifier Power MOSFET's )

Power Mosfet Characteristics

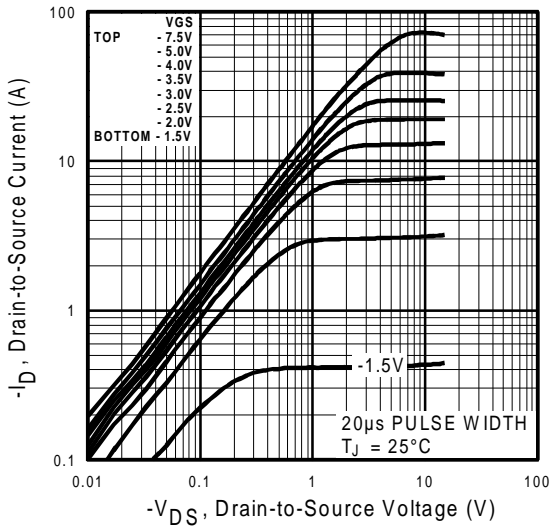

Fig 1. Typical Output Characteristics

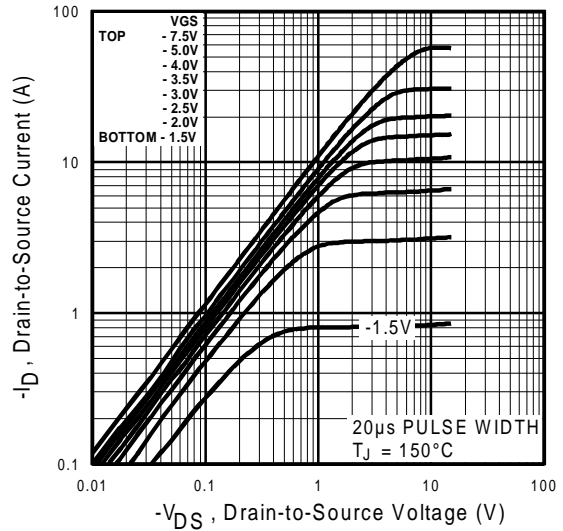

Fig 2. Typical Output Characteristics

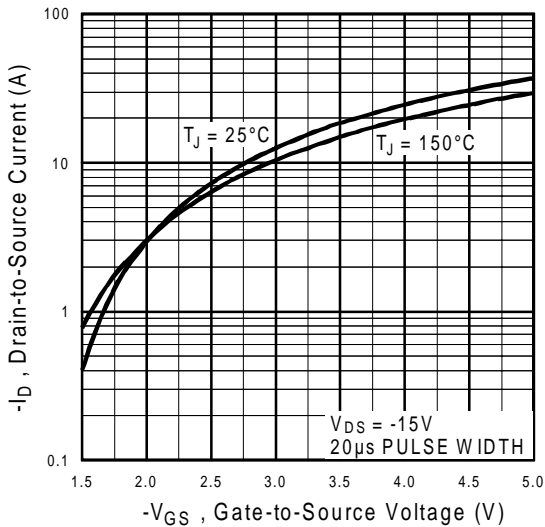

Fig 3. Typical Transfer Characteristics

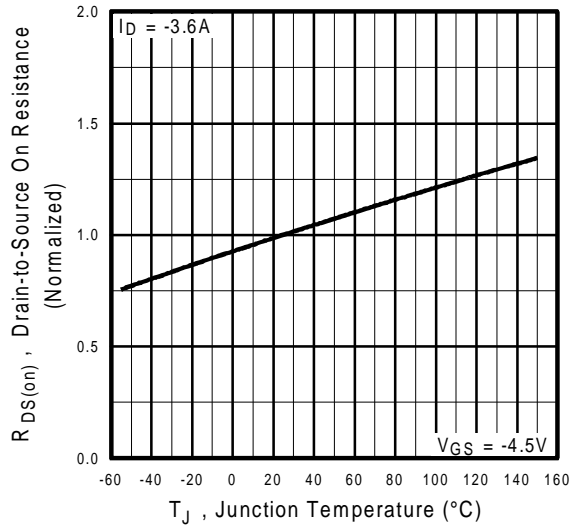
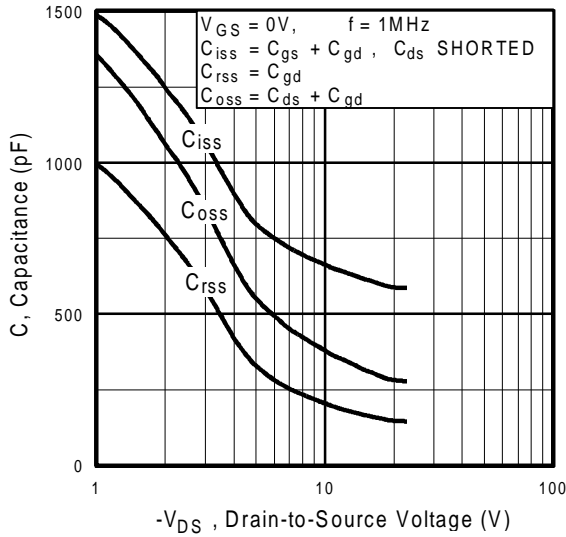
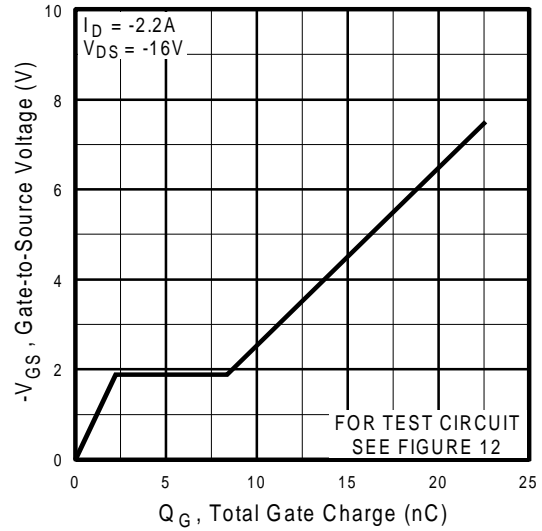

Fig 4. Normalized On-Resistance Vs. Temperature

Power Mosfet Characteristics



**Fig 5.** Typical Capacitance Vs. Drain-to-Source Voltage



**Fig 6.** Typical Gate Charge Vs. Gate-to-Source Voltage

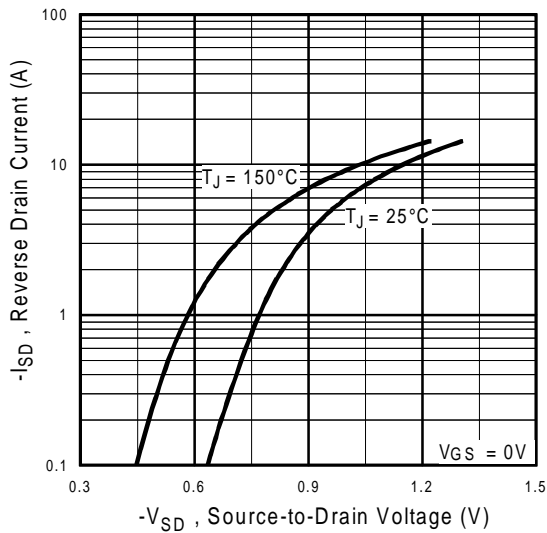

**Fig 7.** Typical Source-Drain Diode Forward Voltage

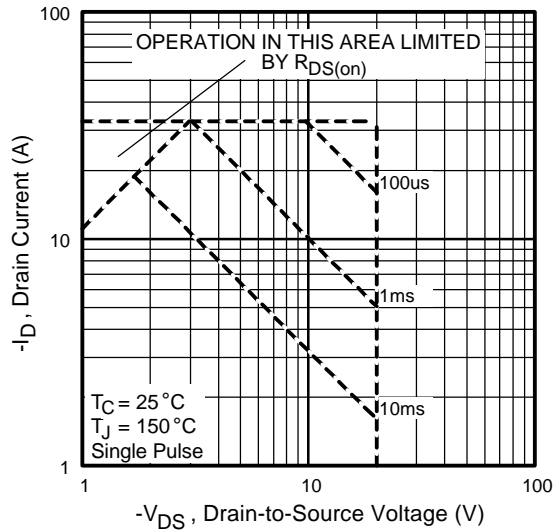

**Fig 8.** Maximum Safe Operating Area

Power Mosfet Characteristics

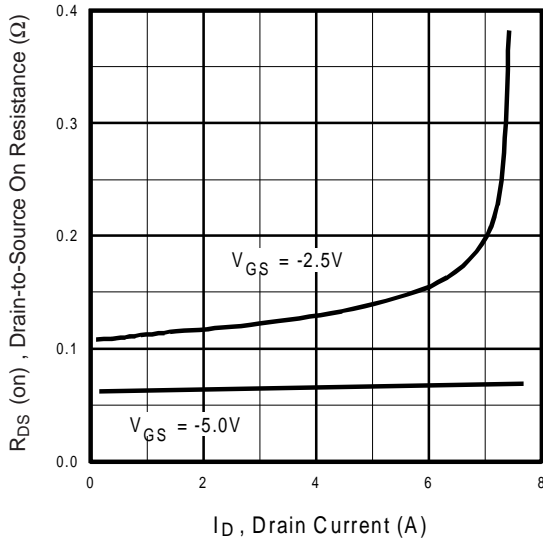
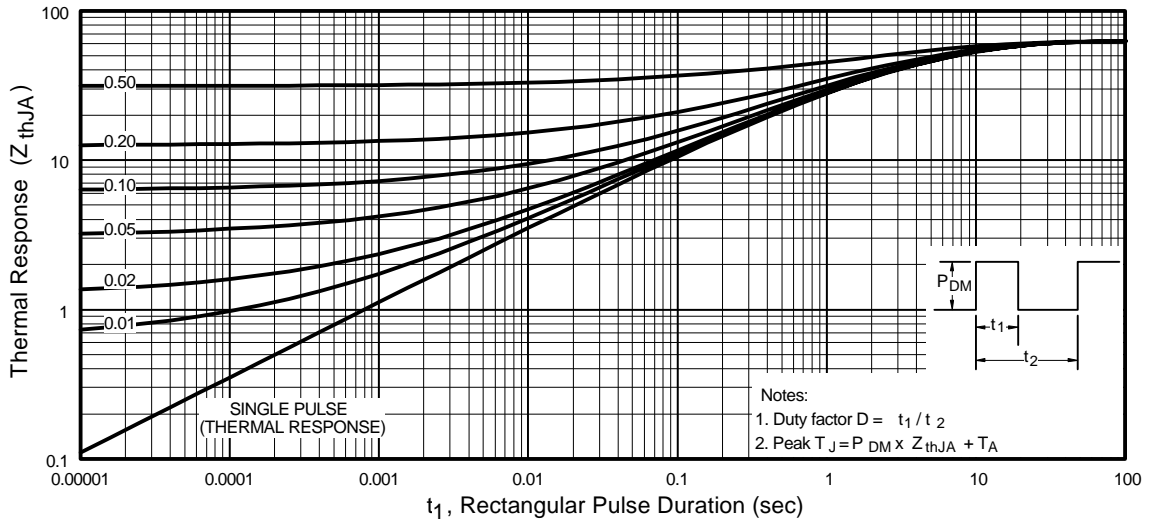

Fig 10. Typical On-Resistance Vs. Drain Current

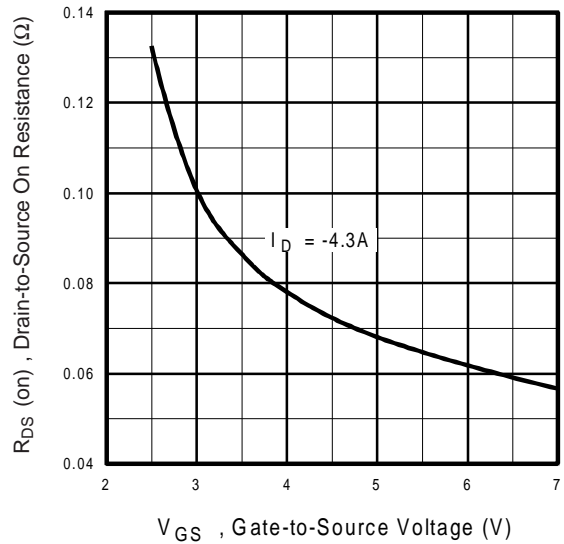

Fig 11. Typical On-Resistance Vs. Gate Voltage

Schottky Diode Characteristics

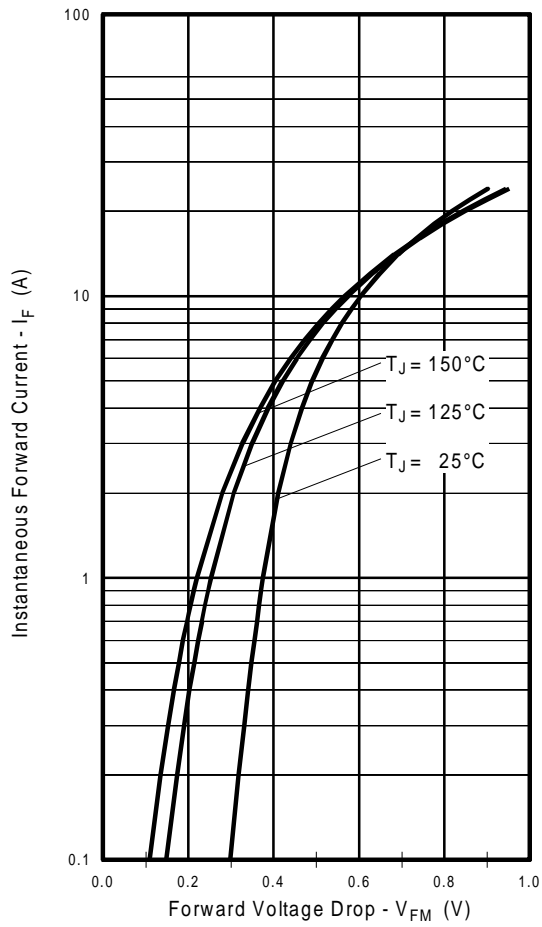

Fig. 12 - Typical Forward Voltage Drop Characteristics

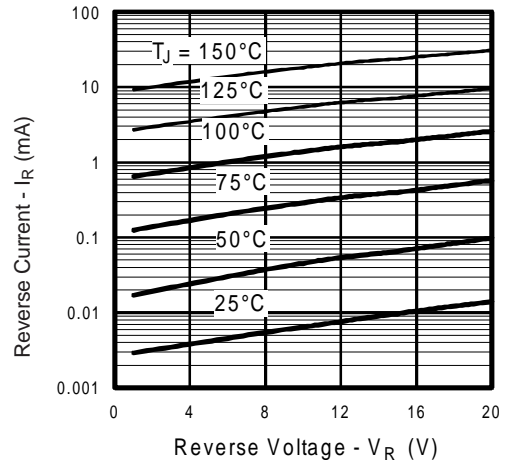

Fig. 13 - Typical Values of Reverse Current Vs. Reverse Voltage

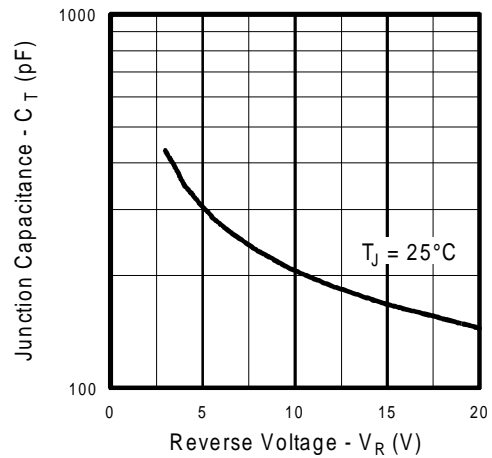
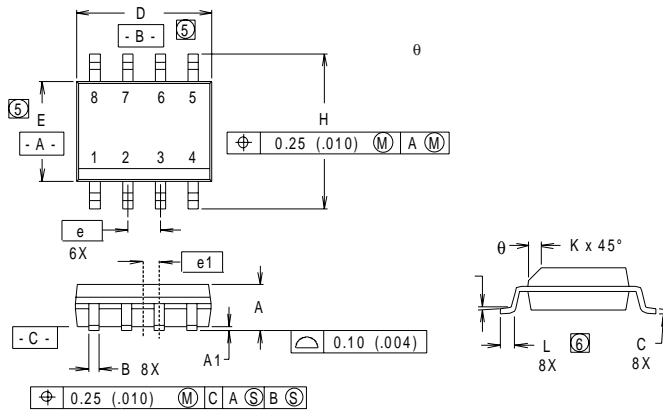

Fig.14 - Typical Junction Capacitance Vs. Reverse Voltage

**SO-8 Package Details**



DIM	INCHES		MILLIMETERS	
	MIN	MAX	MIN	MAX
A	.0532	.0688	1.35	1.75
A1	.0040	.0098	0.10	0.25
B	.014	.018	0.36	0.46
C	.0075	.0098	0.19	0.25
D	.189	.196	4.80	4.98
E	.150	.157	3.81	3.99
e	.050 BASIC		1.27 BASIC	
e1	.025 BASIC		0.635 BASIC	
H	.2284	.2440	5.80	6.20
K	.011	.019	0.28	0.48
L	0.16	.050	0.41	1.27
θ	0°	8°	0°	8°

**RECOMMENDED FOOTPRINT**

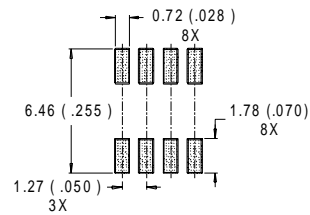

**NOTES:**

1. DIMENSIONING AND TOLERANCING PER ANS Y14.5M-1982.
2. CONTROLLING DIMENSION : INCH.
3. DIMENSIONS ARE SHOWN IN MILLIMETERS (INCHES).
4. OUTLINE CONFORMS TO JEDEC OUTLINE MS-012AA.
- ⑤ DIMENSION DOES NOT INCLUDE MOLD PROTRUSIONS NOT TO EXCEED 0.25 (.006).
- ⑥ DIMENSIONS IS THE LENGTH OF LEAD FOR SOLDERING TO A SUBSTRATE..

**Part Marking**

EXAMPLE: THIS IS AN IRF7101

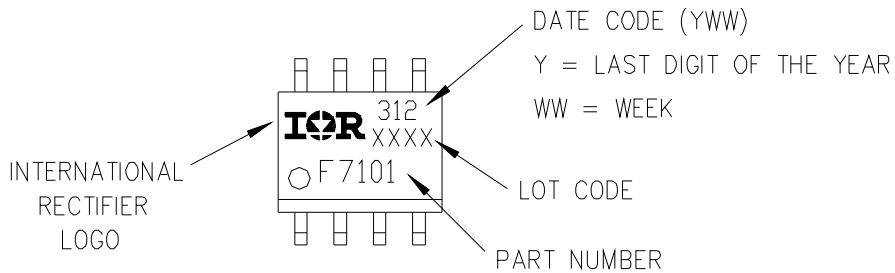

# IRF7422D2

International  
**IR** Rectifier

## Tape and Reel

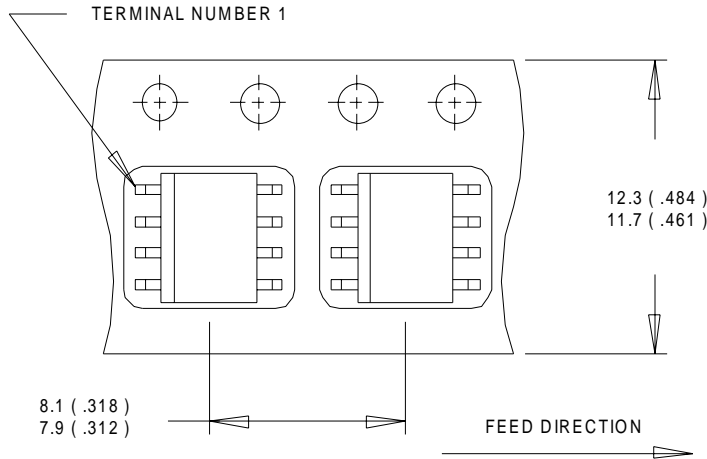

**NOTES:**

1. CONTROLLING DIMENSION : MILLIMETER.
2. ALL DIMENSIONS ARE SHOWN IN MILLIMETERS(INCHES).
3. OUTLINE CONFORMS TO EIA-481 & EIA-541.

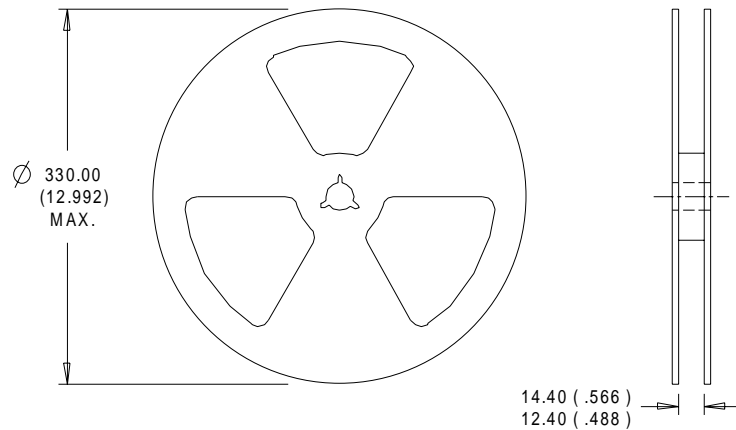

**NOTES :**

1. CONTROLLING DIMENSION : MILLIMETER.
2. OUTLINE CONFORMS TO EIA-481 & EIA-541.

International  
**IR** Rectifier

**WORLD HEADQUARTERS:** 233 Kansas St., El Segundo, California 90245, Tel: (310) 322 3331

**IR GREAT BRITAIN:** Hurst Green, Oxted, Surrey RH8 9BB, UK Tel: ++ 44 1883 732020

**IR CANADA:** 15 Lincoln Court, Brampton, Ontario L6T3Z2, Tel: (905) 453 2200

**IR GERMANY:** Saalburgstrasse 157, 61350 Bad Homburg Tel: ++ 49 6172 96590

**IR ITALY:** Via Liguria 49, 10071 Borgaro, Torino Tel: ++ 39 11 451 0111

**IR FAR EAST:** K&H Bldg., 2F, 30-4 Nishi-Ikebukuro 3-Chome, Toshima-Ku, Tokyo Japan 171 Tel: 81 3 3983 0086

**IR SOUTHEAST ASIA:** 1 Kim Seng Promenade, Great World City West Tower, 13-11, Singapore 237994 Tel: ++ 65 221 8371

**IR TAIWAN:** 16 Fl. Suite D. 207, Sec. 2, Tun Haw South Road, Taipei, 10673, Taiwan Tel: 886-2-2377-9936

<http://www.irf.com/> Data and specifications subject to change without notice.8/98