

N - CHANNEL ENHANCEMENT MODE POWER MOS TRANSISTORS

TYPE	V _{DSS}	R _{DS(on)}	I _D [■]
IRF840	500 V	0.85 Ω	8 A
IRF840FI	500 V	0.85 Ω	4.5 A
IRF841	450 V	0.85 Ω	8 A
IRF841FI	450 V	0.85 Ω	4.5 A
IRF842	500 V	1.1 Ω	7 A
IRF842FI	500 V	1.1 Ω	4 A
IRF843	450 V	1.1 Ω	7 A
IRF843FI	450 V	1.1 Ω	4 A

- HIGH VOLTAGE - 450 V FOR OFF LINE SMPS
- ULTRA FAST SWITCHING - FOR OPERATION AT > 100KHz
- EASY DRIVE- FOR REDUCED COST AND SIZE
- COST EFFECTIVE PLASTIC PACKAGE

INDUSTRIAL APPLICATIONS:

- SWITCHING POWER SUPPLIES
- MOTOR CONTROLS

N - channel enhancement mode POWER MOS field effect transistors. Easy drive and very fast switching times make these POWER MOS transistors ideal for high speed switching applications.

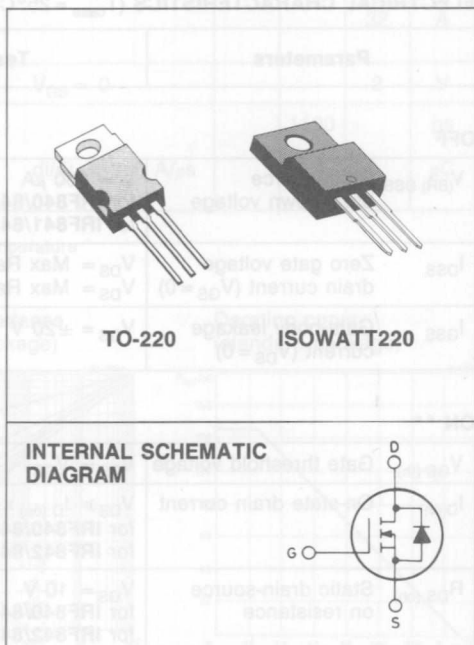

ABSOLUTE MAXIMUM RATINGS

		IRF					
		TO-220 ISOWATT220	840 840FI	841 841FI	842 842FI		843 843FI
V _{DS} *	Drain-source voltage (V _{GS} = 0)		500	450	500	450	V
V _{DGR} *	Drain-gate voltage (R _{GS} = 20 KΩ)		500	450	500	450	V
V _{GS}	Gate-source voltage		±20				V
I _{DM} (•)	Drain current (pulsed)		32	32	28	28	A
I _{DLM}	Drain inductive current, clamped (L = 100 μH)		32	32	28	28	A
I _D	Drain current (cont.) at T _c = 25°C		840	841	842	843	A
I _D	Drain current (cont.) at T _c = 100°C		8	8	7	7	A
			5.1	5.1	4.4	4.4	A
I _D [■]	Drain current (cont.) at T _c = 25°C		840FI	841FI	842FI	843FI	A
I _D [■]	Drain current (cont.) at T _c = 100°C		4.5	4.5	4	4	A
			2.8	2.8	2.5	2.5	A
P _{tot} [■]	Total dissipation at T _c < 25°C		TO-220		ISOWATT220		W
	Derating factor		125		40		W
			1		0.32		W/°C
T _{stg}	Storage temperature		-55 to 150				°C
T _j	Max. operating junction temperature		150				°C

* T_j = 25°C to 125°C

(•) Repetitive Rating: Pulse width limited by max junction temperature.

■ See note on ISOWATT220 on this datasheet.

THERMAL DATA *

		TO-220		ISOWATT220	
$R_{thj-case}$	Thermal resistance junction-case	max	1	3.12	°C/W
R_{thc-s}	Thermal resistance case-sink	typ	0.5		°C/W
$R_{thj-amb}$	Thermal resistance junction-ambient	max	80		°C/W
T_l	Maximum lead temperature for soldering purpose		300		°C

ELECTRICAL CHARACTERISTICS ($T_{case} = 25^\circ\text{C}$ unless otherwise specified)

Parameters	Test Conditions	Min.	Typ.	Max.	Unit
------------	-----------------	------	------	------	------

OFF

$V_{(BR)DSS}$	Drain-source breakdown voltage	$I_D = 250 \mu\text{A}$ for IRF840/842/840FI/842FI for IRF841/843/841FI/843FI	$V_{GS} = 0$	500 450		V V
I_{DSS}	Zero gate voltage drain current ($V_{GS} = 0$)	$V_{DS} = \text{Max Rating}$ $V_{DS} = \text{Max Rating} \times 0.8$	$T_C = 125^\circ\text{C}$		250 1000	μA μA
I_{GSS}	Gate-body leakage current ($V_{DS} = 0$)	$V_{GS} = \pm 20 \text{ V}$			± 500	nA

ON **

$V_{GS(th)}$	Gate threshold voltage	$V_{DS} = V_{GS}$	$I_D = 250 \mu\text{A}$	2	4	V
$I_{D(on)}$	On-state drain current	$V_{DS} > I_{D(on)} \times R_{DS(on)max}$ for IRF840/841/840FI/841FI for IRF842/843/842FI/843FI	$V_{GS} = 10 \text{ V}$	8 7		A A
$R_{DS(on)}$	Static drain-source on resistance	$V_{GS} = 10 \text{ V}$ for IRF840/841/840FI/841FI for IRF842/843/842FI/843FI	$I_D = 4.4 \text{ A}$		0.85 1.1	Ω Ω

DYNAMIC

g_{fs}^{**}	Forward transconductance	$V_{DS} > I_{D(on)} \times R_{DS(on)max}$ $I_D = 4.4 \text{ A}$		4.9		mho
C_{iss}	Input capacitance	$V_{DS} = 25 \text{ V}$ $V_{GS} = 0$	$f = 1 \text{ MHz}$		1600	pF
C_{oss}	Output capacitance				350	pF
C_{rss}	Reverse transfer capacitance				150	pF

SWITCHING

$t_{d(on)}$	Turn-on time	$V_{DD} = 200 \text{ V}$ $R_l = 4.7 \Omega$ $I_D = 4.0 \text{ A}$ (see test circuit)		35	ns
t_r	Rise time			15	ns
$t_{d(off)}$	Turn-off delay time			90	ns
t_f	Fall time			30	ns
Q_g	Total Gate Charge	$V_{GS} = 10 \text{ V}$ $V_{DS} = \text{Max Rating} \times 0.8$ (see test circuit)	$I_D = 8 \text{ A}$	63	nC

ELECTRICAL CHARACTERISTICS (Continued)

Parameters	Test Conditions	Min.	Typ.	Max.	Unit
------------	-----------------	------	------	------	------

SOURCE DRAIN DIODE

I_{SD}	Source-drain current			8	A
$I_{SDM} (*)$	Source-drain current (pulsed)			32	A
$V_{SD} **$	Forward on voltage	$I_{SD} = 8 \text{ A}$	$V_{GS} = 0$	2	V
t_{rr}	Reverse recovery time	$T_J = 150^\circ\text{C}$		1100	ns
Q_{rr}	Reverse recovered charge	$I_{SD} = 8.0 \text{ A}$	$di/dt = 100 \text{ A}/\mu\text{s}$	6.4	μC

** Pulsed: Pulse duration $\leq 300 \mu\text{s}$, duty cycle $\leq 1.5\%$

(*) Repetitive Rating: Pulse width limited by max junction temperature

■ See note on ISOWATT220 in this datasheet

Safe operating areas (standard package)

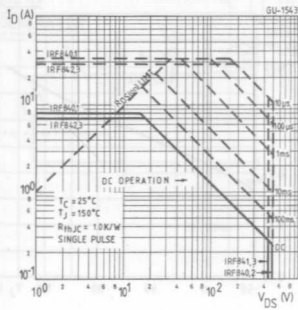

Thermal impedance (standard package)

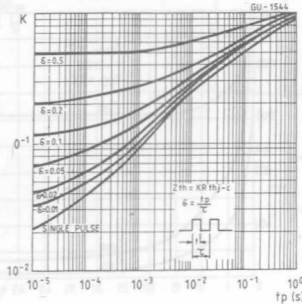

Derating curve (standard package)

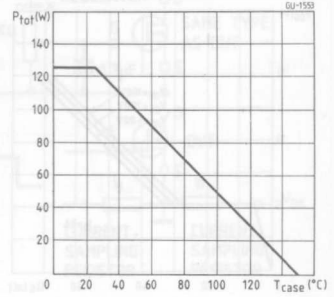

Output characteristics

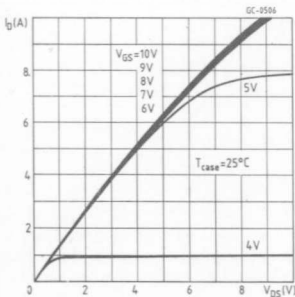

Output characteristics

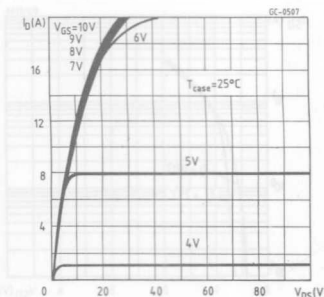

Transfer characteristics

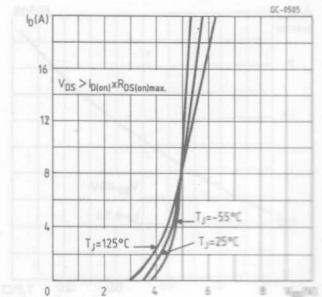

Transconductance

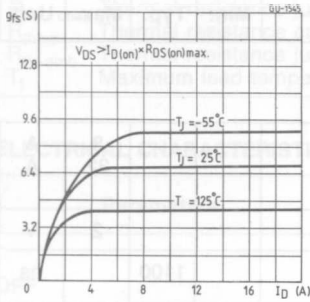

Static drain-source on resistance

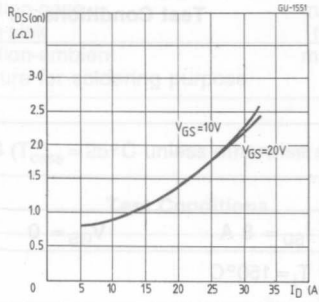

Maximum drain current vs temperature

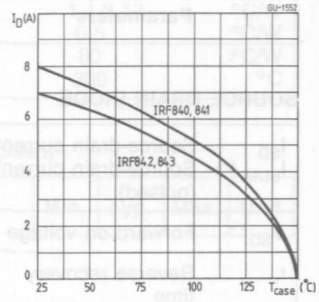

Gate charge vs gate-source voltage

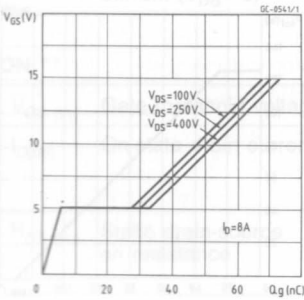

Capacitance variation

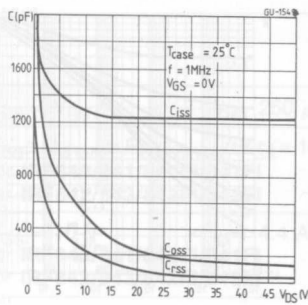

Normalized breakdown voltage vs temperature

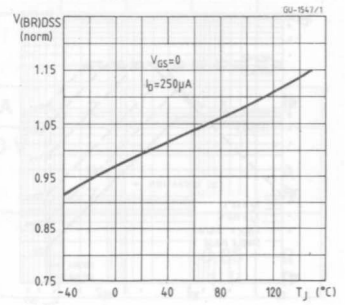

Normalized on resistance vs temperature

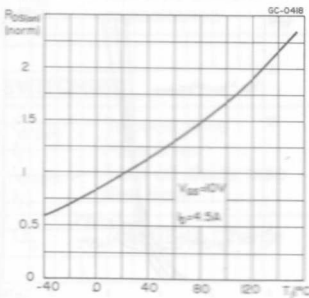

Source-drain diode forward characteristics

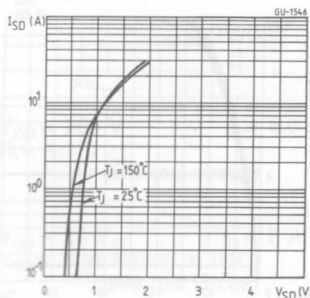

Clamped inductive test circuit

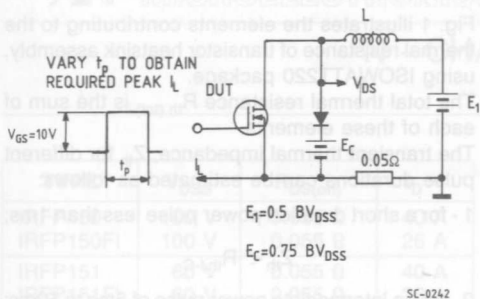

Clamped inductive waveforms

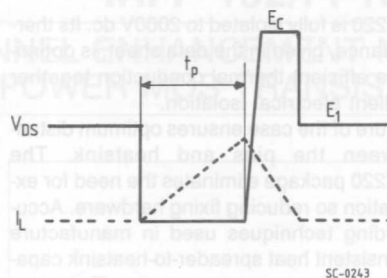

Switching times test circuit

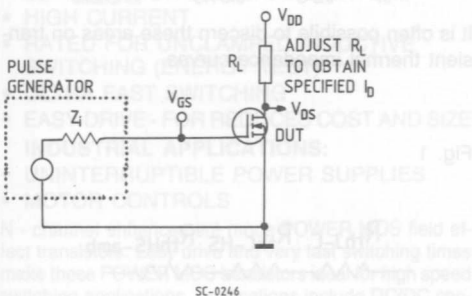

Gate charge test circuit

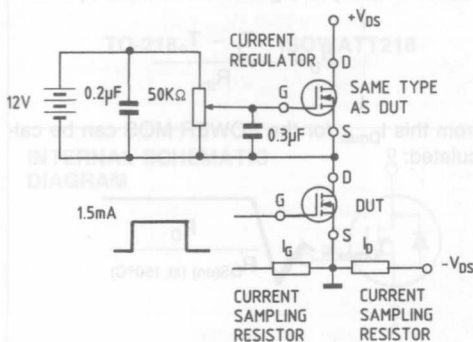

ABSOLUTE MAXIMUM RATINGS

	TO-18	150	151	152	153
	ISOWATT218	150FI	151FI	152FI	153FI
V_{DS}	Drain-source voltage ($V_{GS} = 0$)	100	50	100	50
V_{DGS}	Drain-gate voltage ($I_{DSS} = 20$ mA)	100	50	100	50
V_{GS}	Gate-source voltage		+20		
I_{DSS}	Drain current (continuous) at $T_c = 25^\circ\text{C}$	100	50	100	50
	Drain current (continuous) at $T_c = 100^\circ\text{C}$	40	20	40	20
	Drain current (continuous) at $T_c = 150^\circ\text{C}$	25	12.5	25	12.5
	Drain current (continuous) at $T_c = 200^\circ\text{C}$	15	7.5	15	7.5
	Drain current (continuous) at $T_c = 250^\circ\text{C}$	10	5	10	5
	Drain current (continuous) at $T_c = 300^\circ\text{C}$	5	2.5	5	2.5
	Drain current (continuous) at $T_c = 350^\circ\text{C}$	2.5	1.25	2.5	1.25
	Drain current (continuous) at $T_c = 400^\circ\text{C}$	1.5	0.75	1.5	0.75
	Drain current (continuous) at $T_c = 450^\circ\text{C}$	1	0.5	1	0.5
	Drain current (continuous) at $T_c = 500^\circ\text{C}$	0.5	0.25	0.5	0.25
	Drain current (continuous) at $T_c = 550^\circ\text{C}$	0.25	0.125	0.25	0.125
	Drain current (continuous) at $T_c = 600^\circ\text{C}$	0.15	0.075	0.15	0.075
	Drain current (continuous) at $T_c = 650^\circ\text{C}$	0.1	0.05	0.1	0.05
	Drain current (continuous) at $T_c = 700^\circ\text{C}$	0.05	0.025	0.05	0.025
	Drain current (continuous) at $T_c = 750^\circ\text{C}$	0.025	0.0125	0.025	0.0125
	Drain current (continuous) at $T_c = 800^\circ\text{C}$	0.015	0.0075	0.015	0.0075
	Drain current (continuous) at $T_c = 850^\circ\text{C}$	0.01	0.005	0.01	0.005
	Drain current (continuous) at $T_c = 900^\circ\text{C}$	0.005	0.0025	0.005	0.0025
	Drain current (continuous) at $T_c = 950^\circ\text{C}$	0.0025	0.00125	0.0025	0.00125
	Drain current (continuous) at $T_c = 1000^\circ\text{C}$	0.0015	0.00075	0.0015	0.00075
	Drain current (continuous) at $T_c = 1050^\circ\text{C}$	0.001	0.0005	0.001	0.0005
	Drain current (continuous) at $T_c = 1100^\circ\text{C}$	0.0005	0.00025	0.0005	0.00025
	Drain current (continuous) at $T_c = 1150^\circ\text{C}$	0.00025	0.000125	0.00025	0.000125
	Drain current (continuous) at $T_c = 1200^\circ\text{C}$	0.00015	0.000075	0.00015	0.000075
	Drain current (continuous) at $T_c = 1250^\circ\text{C}$	0.0001	0.00005	0.0001	0.00005
	Drain current (continuous) at $T_c = 1300^\circ\text{C}$	0.00005	0.000025	0.00005	0.000025
	Drain current (continuous) at $T_c = 1350^\circ\text{C}$	0.000025	0.0000125	0.000025	0.0000125
	Drain current (continuous) at $T_c = 1400^\circ\text{C}$	0.000015	0.0000075	0.000015	0.0000075
	Drain current (continuous) at $T_c = 1450^\circ\text{C}$	0.00001	0.000005	0.00001	0.000005
	Drain current (continuous) at $T_c = 1500^\circ\text{C}$	0.000005	0.0000025	0.000005	0.0000025
	Drain current (continuous) at $T_c = 1550^\circ\text{C}$	0.0000025	0.00000125	0.0000025	0.00000125
	Drain current (continuous) at $T_c = 1600^\circ\text{C}$	0.0000015	0.00000075	0.0000015	0.00000075
	Drain current (continuous) at $T_c = 1650^\circ\text{C}$	0.000001	0.0000005	0.000001	0.0000005
	Drain current (continuous) at $T_c = 1700^\circ\text{C}$	0.0000005	0.00000025	0.0000005	0.00000025
	Drain current (continuous) at $T_c = 1750^\circ\text{C}$	0.00000025	0.000000125	0.00000025	0.000000125
	Drain current (continuous) at $T_c = 1800^\circ\text{C}$	0.00000015	0.000000075	0.00000015	0.000000075
	Drain current (continuous) at $T_c = 1850^\circ\text{C}$	0.0000001	0.00000005	0.0000001	0.00000005
	Drain current (continuous) at $T_c = 1900^\circ\text{C}$	0.00000005	0.000000025	0.00000005	0.000000025
	Drain current (continuous) at $T_c = 1950^\circ\text{C}$	0.000000025	0.0000000125	0.000000025	0.0000000125
	Drain current (continuous) at $T_c = 2000^\circ\text{C}$	0.000000015	0.0000000075	0.000000015	0.0000000075
	Drain current (continuous) at $T_c = 2050^\circ\text{C}$	0.00000001	0.000000005	0.00000001	0.000000005
	Drain current (continuous) at $T_c = 2100^\circ\text{C}$	0.000000005	0.0000000025	0.000000005	0.0000000025
	Drain current (continuous) at $T_c = 2150^\circ\text{C}$	0.0000000025	0.00000000125	0.0000000025	0.00000000125
	Drain current (continuous) at $T_c = 2200^\circ\text{C}$	0.0000000015	0.00000000075	0.0000000015	0.00000000075
	Drain current (continuous) at $T_c = 2250^\circ\text{C}$	0.000000001	0.0000000005	0.000000001	0.0000000005
	Drain current (continuous) at $T_c = 2300^\circ\text{C}$	0.0000000005	0.00000000025	0.0000000005	0.00000000025
	Drain current (continuous) at $T_c = 2350^\circ\text{C}$	0.00000000025	0.000000000125	0.00000000025	0.000000000125
	Drain current (continuous) at $T_c = 2400^\circ\text{C}$	0.00000000015	0.000000000075	0.00000000015	0.000000000075
	Drain current (continuous) at $T_c = 2450^\circ\text{C}$	0.0000000001	0.00000000005	0.0000000001	0.00000000005
	Drain current (continuous) at $T_c = 2500^\circ\text{C}$	0.00000000005	0.000000000025	0.00000000005	0.000000000025
	Drain current (continuous) at $T_c = 2550^\circ\text{C}$	0.000000000025	0.0000000000125	0.000000000025	0.0000000000125
	Drain current (continuous) at $T_c = 2600^\circ\text{C}$	0.000000000015	0.0000000000075	0.000000000015	0.0000000000075
	Drain current (continuous) at $T_c = 2650^\circ\text{C}$	0.00000000001	0.000000000005	0.00000000001	0.000000000005
	Drain current (continuous) at $T_c = 2700^\circ\text{C}$	0.000000000005	0.0000000000025	0.000000000005	0.0000000000025
	Drain current (continuous) at $T_c = 2750^\circ\text{C}$	0.0000000000025	0.00000000000125	0.0000000000025	0.00000000000125
	Drain current (continuous) at $T_c = 2800^\circ\text{C}$	0.0000000000015	0.00000000000075	0.0000000000015	0.00000000000075
	Drain current (continuous) at $T_c = 2850^\circ\text{C}$	0.000000000001	0.0000000000005	0.000000000001	0.0000000000005
	Drain current (continuous) at $T_c = 2900^\circ\text{C}$	0.0000000000005	0.00000000000025	0.0000000000005	0.00000000000025
	Drain current (continuous) at $T_c = 2950^\circ\text{C}$	0.00000000000025	0.000000000000125	0.00000000000025	0.000000000000125
	Drain current (continuous) at $T_c = 3000^\circ\text{C}$	0.00000000000015	0.000000000000075	0.00000000000015	0.000000000000075
	Drain current (continuous) at $T_c = 3050^\circ\text{C}$	0.0000000000001	0.00000000000005	0.0000000000001	0.00000000000005
	Drain current (continuous) at $T_c = 3100^\circ\text{C}$	0.00000000000005	0.000000000000025	0.00000000000005	0.000000000000025
	Drain current (continuous) at $T_c = 3150^\circ\text{C}$	0.000000000000025	0.0000000000000125	0.000000000000025	0.0000000000000125
	Drain current (continuous) at $T_c = 3200^\circ\text{C}$	0.000000000000015	0.0000000000000075	0.000000000000015	0.0000000000000075
	Drain current (continuous) at $T_c = 3250^\circ\text{C}$	0.00000000000001	0.000000000000005	0.00000000000001	0.000000000000005
	Drain current (continuous) at $T_c = 3300^\circ\text{C}$	0.000000000000005	0.0000000000000025	0.000000000000005	0.0000000000000025
	Drain current (continuous) at $T_c = 3350^\circ\text{C}$	0.0000000000000025	0.00000000000000125	0.0000000000000025	0.00000000000000125
	Drain current (continuous) at $T_c = 3400^\circ\text{C}$	0.0000000000000015	0.00000000000000075	0.0000000000000015	0.00000000000000075
	Drain current (continuous) at $T_c = 3450^\circ\text{C}$	0.000000000000001	0.0000000000000005	0.000000000000001	0.0000000000000005
	Drain current (continuous) at $T_c = 3500^\circ\text{C}$	0.0000000000000005	0.00000000000000025	0.0000000000000005	0.00000000000000025
	Drain current (continuous) at $T_c = 3550^\circ\text{C}$	0.00000000000000025	0.000000000000000125	0.00000000000000025	0.000000000000000125
	Drain current (continuous) at $T_c = 3600^\circ\text{C}$	0.00000000000000015	0.000000000000000075	0.00000000000000015	0.000000000000000075
	Drain current (continuous) at $T_c = 3650^\circ\text{C}$	0.0000000000000001	0.00000000000000005	0.0000000000000001	0.00000000000000005
	Drain current (continuous) at $T_c = 3700^\circ\text{C}$	0.00000000000000005	0.000000000000000025	0.00000000000000005	0.000000000000000025
	Drain current (continuous) at $T_c = 3750^\circ\text{C}$	0.000000000000000025	0.0000000000000000125	0.000000000000000025	0.0000000000000000125
	Drain current (continuous) at $T_c = 3800^\circ\text{C}$	0.000000000000000015	0.0000000000000000075	0.000000000000000015	0.0000000000000000075
	Drain current (continuous) at $T_c = 3850^\circ\text{C}$	0.00000000000000001	0.000000000000000005	0.00000000000000001	0.000000000000000005
	Drain current (continuous) at $T_c = 3900^\circ\text{C}$	0.000000000000000005	0.0000000000000000025	0.000000000000000005	0.0000000000000000025
	Drain current (continuous) at $T_c = 3950^\circ\text{C}$	0.0000000000000000025	0.00000000000000000125	0.0000000000000000025	0.00000000000000000125
	Drain current (continuous) at $T_c = 4000^\circ\text{C}$	0.0000000000000000015	0.00000000000000000075	0.0000000000000000015	0.00000000000000000075
	Drain current (continuous) at $T_c = 4050^\circ\text{C}$	0.000000000000000001	0.0000000000000000005	0.000000000000000001	0.0000000000000000005
	Drain current (continuous) at $T_c = 4100^\circ\text{C}$	0.0000000000000000005	0.00000000000000000025	0.0000000000000000005	0.00000000000000000025
	Drain current (continuous) at $T_c = 4150^\circ\text{C}$	0.00000000000000000025	0.000000000000000000125	0.00000000000000000025	0.000000000000000000125
	Drain current (continuous) at $T_c = 4200^\circ\text{C}$	0.00000000000000000015	0.000000000000000000075	0.00000000000000000015	0.000000000000000000075
	Drain current (continuous) at $T_c = 4250^\circ\text{C}$	0.0000000000000000001	0.00000000000000000005	0.0000000000000000001	0.00000000000000000005
	Drain current (continuous) at $T_c = 4300^\circ\text{C}$	0.00000000000000000005	0.000000000000000000025	0.00000000000000000005	0.000000000000000000025
	Drain current (continuous) at $T_c = 4350^\circ\text{C}$	0.000000000000000000025	0.0000000000000000000125	0.000000000000000000025	0.0000000000000000000125
	Drain current (continuous) at $T_c = 4400^\circ\text{C}$	0.000000000000000000015	0.0000000000000000000075	0.000000000000000000015	0.0000000000000000000075
	Drain current (continuous) at $T_c = 4450^\circ\text{C}$	0.00000000000000000001	0.000000000000000000005	0.00000000000000000001	0.000000000000000000005
	Drain current (continuous) at $T_c = 4500^\circ\text{C}$	0.000000000000000000005	0.0000000000000000000025	0.000000000000000000005	0.0000000000000000000025
	Drain current (continuous) at $T_c = 4550^\circ\text{C}$	0.0000000000000000000025	0.00000000000000000000125	0.0000000000000000000025	0.00000000000000000000125
	Drain current (continuous) at $T_c = 4600^\circ\text{C}$	0.0000000000000000000015	0.00000000000000000000075	0.0000000000000000000015	0.00000000000000000000075
	Drain current (continuous) at $T_c = 4650^\circ\text{C}$	0.000000000000000000001	0.0000000000000000000005	0.000000000000000000001	0.0000000000000000000005
	Drain current (continuous) at $T_c = 4700^\circ\text{C}$	0.0000000000000000000005	0.00000000000000000000025	0.0000000000000000000005	0.0000000000000

ISOWATT220 PACKAGE CHARACTERISTICS AND APPLICATION.

ISOWATT220 is fully isolated to 2000V dc. Its thermal impedance, given in the data sheet, is optimised to give efficient thermal conduction together with excellent electrical isolation.

The structure of the case ensures optimum distances between the pins and heatsink. The ISOWATT220 package eliminates the need for external isolation so reducing fixing hardware. Accurate moulding techniques used in manufacture assure consistent heat spreader-to-heatsink capacitance.

ISOWATT220 thermal performance is better than that of the standard part, mounted with a 0.1mm mica washer. The thermally conductive plastic has a higher breakdown rating and is less fragile than mica or plastic sheets. Power derating for ISOWATT220 packages is determined by:

$$P_D = \frac{T_j - T_c}{R_{th}}$$

from this I_{Dmax} for the POWER MOS can be calculated:

$$I_{Dmax} \leq \sqrt{\frac{P_D}{R_{DS(on)} \text{ (at } 150^\circ\text{C)}}$$

THERMAL IMPEDANCE OF ISOWATT220 PACKAGE

Fig. 1 illustrates the elements contributing to the thermal resistance of transistor heatsink assembly, using ISOWATT220 package.

The total thermal resistance $R_{th (tot)}$ is the sum of each of these elements.

The transient thermal impedance, Z_{th} for different pulse durations can be estimated as follows:

1 - for a short duration power pulse less than 1ms;

$$Z_{th} < R_{thJ-C}$$

2 - for an intermediate power pulse of 5ms to 50ms:

$$Z_{th} = R_{thJ-C}$$

3 - for long power pulses of the order of 500ms or greater:

$$Z_{th} = R_{thJ-C} + R_{thC-HS} + R_{thHS-amb}$$

It is often possible to discern these areas on transient thermal impedance curves.

Fig. 1

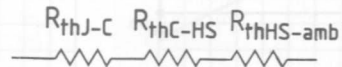

ISOWATT DATA

Safe operating areas

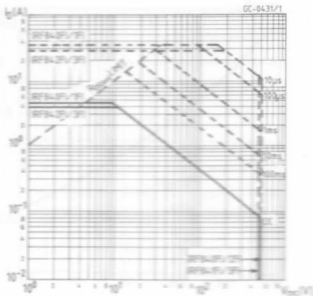

Thermal impedance characteristics

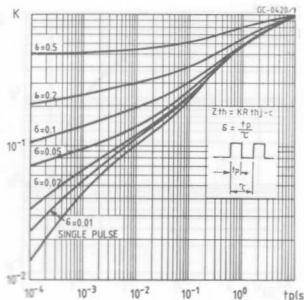

Derating curve

