

N - CHANNEL ENHANCEMENT MODE POWER MOS TRANSISTORS

TYPE	V _{DSS}	R _{DS(on)}	I _D [■]
IRF840	500 V	0.85 Ω	8 A
IRF840FI	500 V	0.85 Ω	4.5 A
IRF841	450 V	0.85 Ω	8 A
IRF841FI	450 V	0.85 Ω	4.5 A
IRF842	500 V	1.1 Ω	7 A
IRF842FI	500 V	1.1 Ω	4 A
IRF843	450 V	1.1 Ω	7 A
IRF843FI	450 V	1.1 Ω	4 A

- HIGH VOLTAGE - 450 V FOR OFF LINE SMPS
- ULTRA FAST SWITCHING - FOR OPERATION AT > 100KHz
- EASY DRIVE- FOR REDUCED COST AND SIZE
- COST EFFECTIVE PLASTIC PACKAGE

INDUSTRIAL APPLICATIONS:

- SWITCHING POWER SUPPLIES
- MOTOR CONTROLS

N - channel enhancement mode POWER MOS field effect transistors. Easy drive and very fast switching times make these POWER MOS transistors ideal for high speed switching applications.

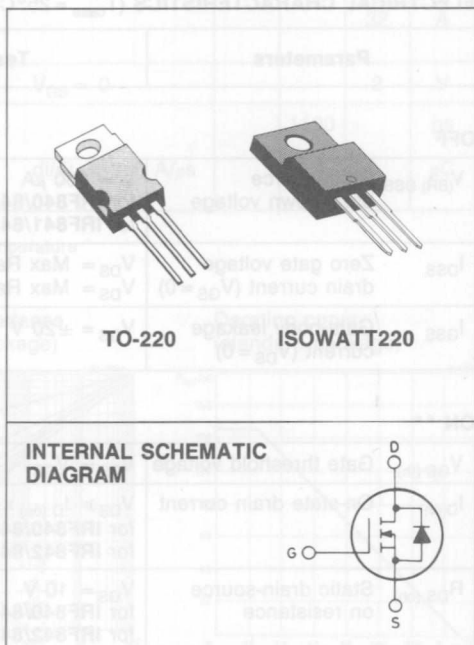

ABSOLUTE MAXIMUM RATINGS

		TO-220		IRF				
		ISOWATT220		840	841	842	843	
		840FI	841FI	842FI	843FI			
V _{DS} *	Drain-source voltage (V _{GS} = 0)	500	450	500	450		V	
V _{DGR} *	Drain-gate voltage (R _{GS} = 20 KΩ)	500	450	500	450		V	
V _{GS}	Gate-source voltage	±20					V	
I _{DM} (•)	Drain current (pulsed)	32	32	28	28		A	
I _{DLM}	Drain inductive current, clamped (L = 100 μH)	32	32	28	28		A	
I _D	Drain current (cont.) at T _c = 25°C	840	841	842	843		A	
I _D	Drain current (cont.) at T _c = 100°C	8	8	7	7		A	
		5.1	5.1	4.4	4.4		A	
I _D [■]	Drain current (cont.) at T _c = 25°C	840FI	841FI	842FI	843FI		A	
I _D [■]	Drain current (cont.) at T _c = 100°C	4.5	4.5	4	4		A	
		2.8	2.8	2.5	2.5		A	
		TO-220		ISOWATT220				
P _{tot} [■]	Total dissipation at T _c < 25°C	125		40			W	
	Derating factor	1		0.32			W/°C	
T _{stg}	Storage temperature	-55 to 150					°C	
T _j	Max. operating junction temperature	150					°C	

* T_j = 25°C to 125°C

(•) Repetitive Rating: Pulse width limited by max junction temperature.

■ See note on ISOWATT220 on this datasheet.

THERMAL DATA *

		TO-220		ISOWATT220	
$R_{thj-case}$	Thermal resistance junction-case	max	1	3.12	°C/W
R_{thc-s}	Thermal resistance case-sink	typ	0.5		°C/W
$R_{thj-amb}$	Thermal resistance junction-ambient	max	80		°C/W
T_l	Maximum lead temperature for soldering purpose		300		°C

ELECTRICAL CHARACTERISTICS ($T_{case} = 25^\circ\text{C}$ unless otherwise specified)

Parameters	Test Conditions	Min.	Typ.	Max.	Unit
------------	-----------------	------	------	------	------

OFF

$V_{(BR)DSS}$	Drain-source breakdown voltage	$I_D = 250 \mu\text{A}$ for IRF840/842/840FI/842FI for IRF841/843/841FI/843FI	$V_{GS} = 0$	500 450		V V
I_{DSS}	Zero gate voltage drain current ($V_{GS} = 0$)	$V_{DS} = \text{Max Rating}$ $V_{DS} = \text{Max Rating} \times 0.8$	$T_C = 125^\circ\text{C}$		250 1000	μA μA
I_{GSS}	Gate-body leakage current ($V_{DS} = 0$)	$V_{GS} = \pm 20 \text{ V}$			± 500	nA

ON **

$V_{GS(th)}$	Gate threshold voltage	$V_{DS} = V_{GS}$	$I_D = 250 \mu\text{A}$	2	4	V
$I_{D(on)}$	On-state drain current	$V_{DS} > I_{D(on)} \times R_{DS(on)max}$ for IRF840/841/840FI/841FI for IRF842/843/842FI/843FI	$V_{GS} = 10 \text{ V}$	8 7		A A
$R_{DS(on)}$	Static drain-source on resistance	$V_{GS} = 10 \text{ V}$ for IRF840/841/840FI/841FI for IRF842/843/842FI/843FI	$I_D = 4.4 \text{ A}$		0.85 1.1	Ω Ω

DYNAMIC

g_{fs}^{**}	Forward transconductance	$V_{DS} > I_{D(on)} \times R_{DS(on)max}$ $I_D = 4.4 \text{ A}$		4.9		mho
C_{iss}	Input capacitance	$V_{DS} = 25 \text{ V}$ $V_{GS} = 0$	$f = 1 \text{ MHz}$		1600	pF
C_{oss}	Output capacitance				350	pF
C_{rss}	Reverse transfer capacitance				150	pF

SWITCHING

$t_{d(on)}$	Turn-on time	$V_{DD} = 200 \text{ V}$ $R_l = 4.7 \Omega$ $I_D = 4.0 \text{ A}$ (see test circuit)		35	ns
t_r	Rise time			15	ns
$t_{d(off)}$	Turn-off delay time			90	ns
t_f	Fall time			30	ns
Q_g	Total Gate Charge		$V_{GS} = 10 \text{ V}$ $V_{DS} = \text{Max Rating} \times 0.8$ (see test circuit)	$I_D = 8 \text{ A}$	63

ELECTRICAL CHARACTERISTICS (Continued)

Parameters	Test Conditions	Min.	Typ.	Max.	Unit
------------	-----------------	------	------	------	------

SOURCE DRAIN DIODE

I_{SD}	Source-drain current			8	A
$I_{SDM} (*)$	Source-drain current (pulsed)			32	A
$V_{SD} **$	Forward on voltage	$I_{SD} = 8\text{ A}$	$V_{GS} = 0$	2	V
t_{rr}	Reverse recovery time	$T_J = 150^\circ\text{C}$		1100	ns
Q_{rr}	Reverse recovered charge	$I_{SD} = 8.0\text{ A}$	$di/dt = 100\text{ A}/\mu\text{s}$	6.4	μC

** Pulsed: Pulse duration $\leq 300\ \mu\text{s}$, duty cycle $\leq 1.5\%$

(*) Repetitive Rating: Pulse width limited by max junction temperature

■ See note on ISOWATT220 in this datasheet

Safe operating areas (standard package)

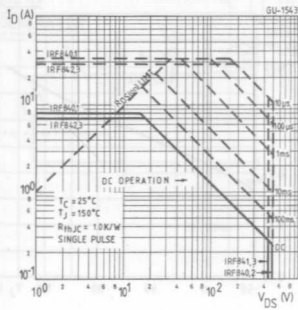

Thermal impedance (standard package)

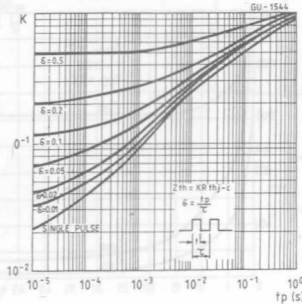

Derating curve (standard package)

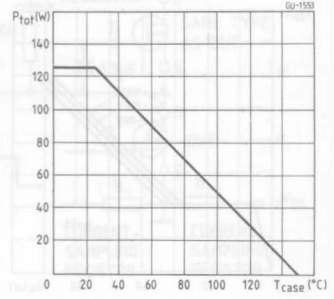

Output characteristics

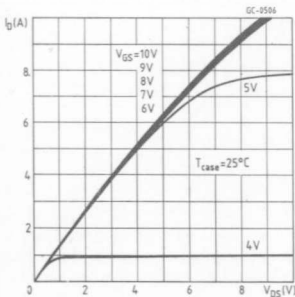

Output characteristics

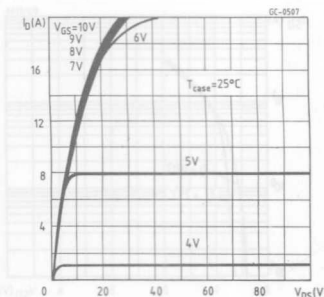

Transfer characteristics

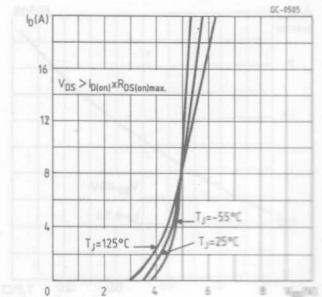

Transconductance

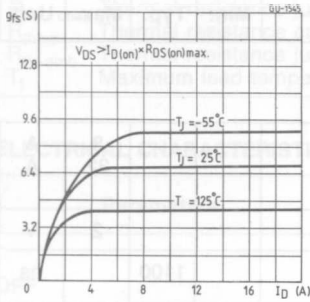

Static drain-source on resistance

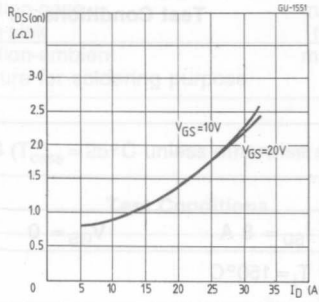

Maximum drain current vs temperature

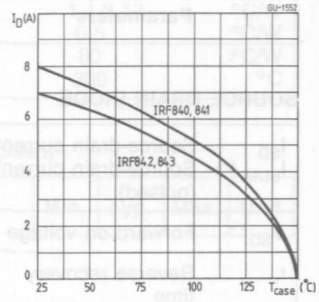

Gate charge vs gate-source voltage

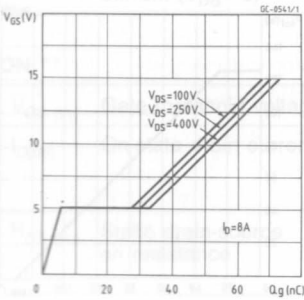

Capacitance variation

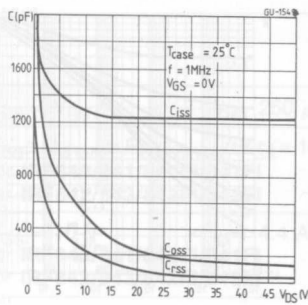

Normalized breakdown voltage vs temperature

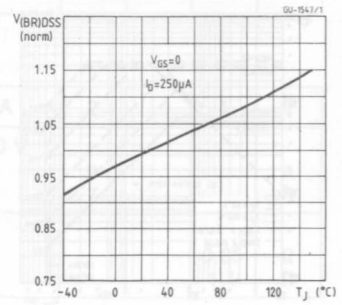

Normalized on resistance vs temperature

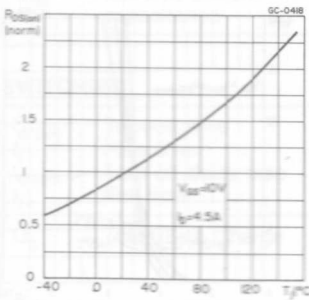

Source-drain diode forward characteristics

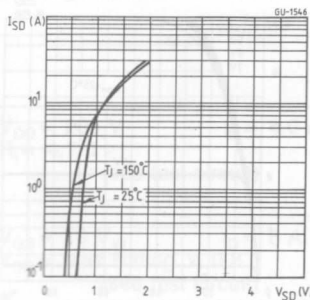

Clamped inductive test circuit

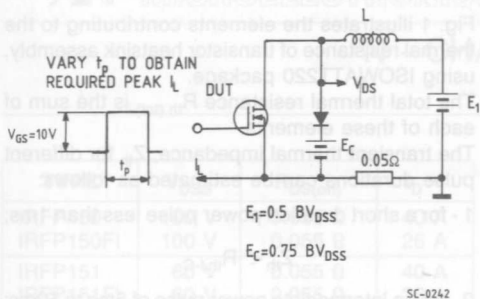

Clamped inductive waveforms

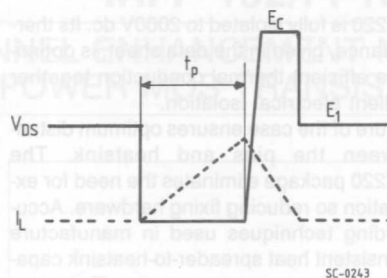

Switching times test circuit

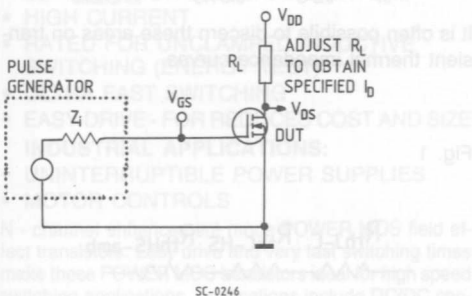

Gate charge test circuit

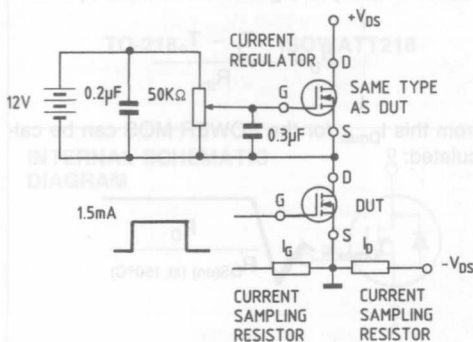

ABSOLUTE MAXIMUM RATINGS

	TO-18	IRFP	TO-18		
	ISOWATT218	151FI 151FI 152FI 153FI	150 151 152 153		
V_{DS}	Drain-source voltage ($V_{GS} = 0$)	100	100	100	100
V_{DGS}	Drain-gate voltage ($I_{DSS} = 20$ KA)	100	100	100	100
V_{GS}	Gate-source voltage	±20	±20	±20	±20
I_{DSS}	Drain-source current (pulsed)	100	100	100	100
$R_{\theta JC}$	Thermal impedance	100	100	100	100
I_{D}	Drain current (cont.) at $T_c = 25^\circ C$	40	40	40	40
I_{D}	Drain current (cont.) at $T_c = 100^\circ C$	25	25	25	25
I_{D}	Drain current (cont.) at $T_c = 150^\circ C$	20	20	20	20
I_{D}	Drain current (cont.) at $T_c = 175^\circ C$	15	15	15	15
P_{tot}	Total dissipation at $T_c = 25^\circ C$	1.0	1.0	1.0	1.0
T_{vj}	Junction temperature	150	150	150	150
T_{vj}	Junction temperature (max)	175	175	175	175

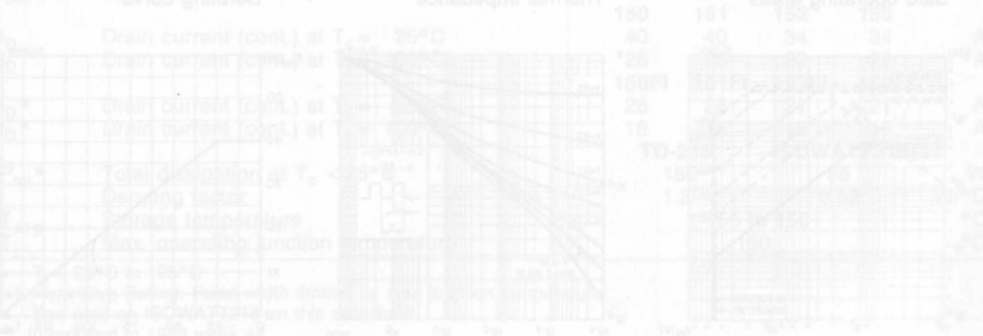

ISOWATT220 PACKAGE CHARACTERISTICS AND APPLICATION.

ISOWATT220 is fully isolated to 2000V dc. Its thermal impedance, given in the data sheet, is optimised to give efficient thermal conduction together with excellent electrical isolation.

The structure of the case ensures optimum distances between the pins and heatsink. The ISOWATT220 package eliminates the need for external isolation so reducing fixing hardware. Accurate moulding techniques used in manufacture assure consistent heat spreader-to-heatsink capacitance.

ISOWATT220 thermal performance is better than that of the standard part, mounted with a 0.1mm mica washer. The thermally conductive plastic has a higher breakdown rating and is less fragile than mica or plastic sheets. Power derating for ISOWATT220 packages is determined by:

$$P_D = \frac{T_j - T_c}{R_{th}}$$

from this I_{Dmax} for the POWER MOS can be calculated:

$$I_{Dmax} \leq \sqrt{\frac{P_D}{R_{DS(on)} \text{ (at } 150^\circ\text{C)}}$$

THERMAL IMPEDANCE OF ISOWATT220 PACKAGE

Fig. 1 illustrates the elements contributing to the thermal resistance of transistor heatsink assembly, using ISOWATT220 package.

The total thermal resistance $R_{th (tot)}$ is the sum of each of these elements.

The transient thermal impedance, Z_{th} for different pulse durations can be estimated as follows:

1 - for a short duration power pulse less than 1ms;

$$Z_{th} < R_{thJ-C}$$

2 - for an intermediate power pulse of 5ms to 50ms:

$$Z_{th} = R_{thJ-C}$$

3 - for long power pulses of the order of 500ms or greater:

$$Z_{th} = R_{thJ-C} + R_{thC-HS} + R_{thHS-amb}$$

It is often possible to discern these areas on transient thermal impedance curves.

Fig. 1

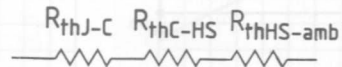

ISOWATT DATA

Safe operating areas

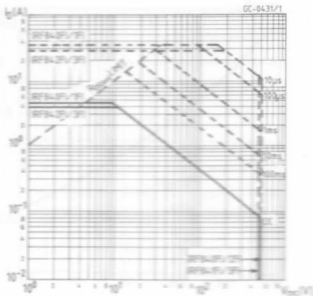

Thermal impedance characteristics

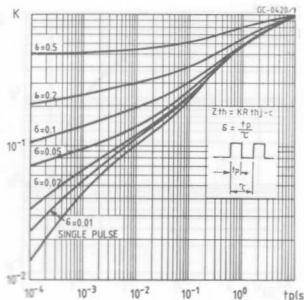

Derating curve

