

## N - CHANNEL ENHANCEMENT MODE POWER MOS TRANSISTORS

TYPE	V <sub>DSS</sub>	R <sub>DS(on)</sub>	I <sub>D</sub> <sup>■</sup>
IRFP150	100 V	0.055 Ω	40 A
IRFP150FI	100 V	0.055 Ω	26 A
IRFP151	60 V	0.055 Ω	40 A
IRFP151FI	60 V	0.055 Ω	26 A
IRFP152	100 V	0.08 Ω	34 A
IRFP152FI	100 V	0.08 Ω	21 A
IRFP153	60 V	0.08 Ω	34 A
IRFP153FI	60 V	0.08 Ω	21 A

- 60 - 100 V FOR DC/DC CONVERTERS
- HIGH CURRENT
- RATED FOR UNCLAMPED INDUCTIVE SWITCHING (ENERGY TEST) <sup>◆</sup>
- ULTRA FAST SWITCHING
- EASY DRIVE - FOR REDUCES COST AND SIZE

### INDUSTRIAL APPLICATIONS:

- UNINTERRUPTIBLE POWER SUPPLIES
- MOTOR CONTROLS

N - channel enhancement mode POWER MOS field effect transistors. Easy drive and very fast switching times make these POWER MOS transistors ideal for high speed switching applications. Applications include DC/DC converters, UPS, battery chargers, secondary regulators, servo control, power audio amplifiers and robotics.

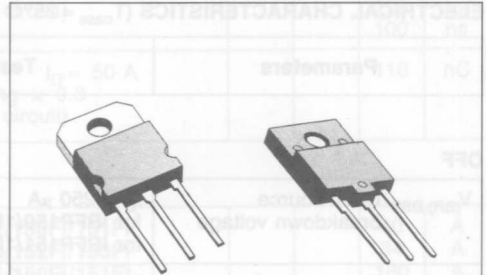

TO-218

ISOWATT218

### INTERNAL SCHEMATIC DIAGRAM

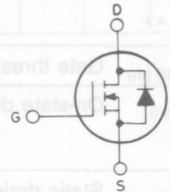

### ABSOLUTE MAXIMUM RATINGS

		IRFP					
		TO-218 ISOWATT218	150 150FI	151 151FI	152 152FI		153 153FI
V <sub>DS</sub> *	Drain-source voltage (V <sub>GS</sub> = 0)		100	60	100	60	V
V <sub>DGR</sub> *	Drain-gate voltage (R <sub>GS</sub> = 20 KΩ)		100	60	100	60	V
V <sub>GS</sub>	Gate-source voltage			±20			V
I <sub>DM</sub> (•)	Drain current (pulsed)		160	160	140	140	A
I <sub>D</sub>	Drain current (cont.) at T <sub>c</sub> = 25°C		40	40	34	34	A
I <sub>D</sub>	Drain current (cont.) at T <sub>c</sub> = 100°C		26	26	22	22	A
I <sub>D</sub> <sup>■</sup>	Drain current (cont.) at T <sub>c</sub> = 25°C		26	26	21	21	A
I <sub>D</sub> <sup>■</sup>	Drain current (cont.) at T <sub>c</sub> = 100°C		16	16	13	13	A
P <sub>tot</sub> <sup>■</sup>	Total dissipation at T <sub>c</sub> < 25°C		TO-218		ISOWATT218		W
	Derating factor		150		65		W/°C
T <sub>stg</sub>	Storage temperature		1.2		0.52		°C
T <sub>j</sub>	Max. operating junction temperature		-55 to 150				°C
			150				°C

\* T<sub>j</sub> = 25°C to 125°C

(•) Repetitive Rating: Pulse width limited by max junction temperature.

■ See note on ISOWATT218 on this datasheet.

◆ Introduced in 1988 week 44

**THERMAL DATA \***

			TO-218	ISOWATT218	
$R_{thj-case}$	Thermal resistance junction-case	max	0.83	1.92	°C/W
$R_{thc-s}$	Thermal resistance case-sink	typ		0.1	°C/W
$R_{thj-amb}$	Thermal resistance junction-ambient	max		30	°C/W
$T_I$	Maximum lead temperature for soldering purpose			300	°C

**ELECTRICAL CHARACTERISTICS** ( $T_{case} = 25^\circ\text{C}$  unless otherwise specified)

Parameters	Test Conditions	Min.	Typ.	Max.	Unit
------------	-----------------	------	------	------	------

**OFF**

$V_{(BR) DSS}$	Drain-source breakdown voltage	$I_D = 250 \mu\text{A}$ for IRFP150/152/150FI/152FI for IRFP151/153/151FI/153FI	$V_{GS} = 0$	100 60	V V
$I_{DSS}$	Zero gate voltage drain current ( $V_{GS} = 0$ )	$V_{DS} = \text{Max Rating}$ $V_{DS} = \text{Max Rating} \times 0.8$	$T_c = 125^\circ\text{C}$		250 1000 $\mu\text{A}$ $\mu\text{A}$
$I_{GSS}$	Gate-body leakage current ( $V_{DS} = 0$ )	$V_{GS} = \pm 20 \text{ V}$			$\pm 100$ nA

**ON \*\***

$V_{GS(th)}$	Gate threshold voltage	$V_{DS} = V_{GS}$	$I_D = 250 \mu\text{A}$	2		4	V
$I_{D(on)}$	On-state drain current	$V_{DS} > I_{D(on)} \times R_{DS(on) max}$	$V_{GS} = 10 \text{ V}$ for IRFP150/151/150FI/151FI for IRFP152/153/152FI/153FI	40 34			A A
$R_{DS(on)}$	Static drain-source on resistance	$V_{GS} = 10 \text{ V}$ for IRFP150/151/150FI/151FI for IRFP152/153/152FI/153FI	$I_D = 22 \text{ A}$			0.055 0.08	$\Omega$ $\Omega$

**ENERGY TEST**

$I_{UIS}$	Unclamped inductive switching current (single pulse)	$V_{DD} = 30 \text{ V}$ starting $T_I = 25^\circ\text{C}$ for IRFP150/151/150FI/151FI for IRFP152/153/152FI/153FI	$L = 100 \mu\text{H}$	40 34			A A
-----------	--	--	-----------------------	----------	--	--	--------

**DYNAMIC**

$g_{fs}^{**}$	Forward transconductance	$V_{DS} > I_{D(on)} \times R_{DS(on) max}$ $I_D = 22 \text{ A}$		13			mho
$C_{iss}$	Input capacitance					3000	pF
$C_{oss}$	Output capacitance	$V_{DS} = 25 \text{ V}$	$f = 1 \text{ MHz}$			1500	pF
$C_{rss}$	Reverse transfer capacitance	$V_{GS} = 0$				500	pF

**ELECTRICAL CHARACTERISTICS (Continued)**

Parameters		Test Conditions	Min.	Typ.	Max.	Unit
<b>SWITCHING</b>						
$t_d$ (on)	Turn-on time	$V_{DD} = 24\text{ V}$ $I_D = 20\text{ A}$ $R_1 = 4.7\ \Omega$ (see test circuit)			35	ns
$t_r$	Rise time				100	ns
$t_d$ (off)	Turn-off delay time				125	ns
$t_f$	Fall time				100	ns
$Q_g$	Total Gate Charge	$V_{GS} = 10\text{ V}$ $I_D = 50\text{ A}$ $V_{DS} = \text{Max Rating} \times 0.8$ (see test circuit)			110	nC

**SOURCE DRAIN DIODE**

$I_{SD}$	Source-drain current	for <b>IRFP150/151/150FI/151FI</b> for <b>IRFP152/153/152FI/153FI</b>			40	A
$I_{SDM}$ (*)	Source-drain current (pulsed)	for <b>IRFP150/151/150FI/151FI</b> for <b>IRFP152/153/152FI/153FI</b>			34	A
					160	A
					140	A
$V_{SD}^{**}$	Forward on voltage	$I_{SD} = 40\text{ A}$ $V_{GS} = 0$			2.5	V
$t_{rr}$	Reverse recovery time	$T_j = 150^\circ\text{C}$		600		ns
$Q_{rr}$	Reverse recovered charge	$I_{SD} = 40\text{ A}$ $di/dt = 100\text{ A}/\mu\text{s}$		3.3		$\mu\text{C}$

\*\* Pulsed: Pulse duration  $\leq 300\ \mu\text{s}$ , duty cycle  $\leq 1.5\%$

(\*) Repetitive Rating: Pulse width limited by max junction temperature

■ See note on ISOWATT220 in this datasheet

**Safe operating areas (standard package)**

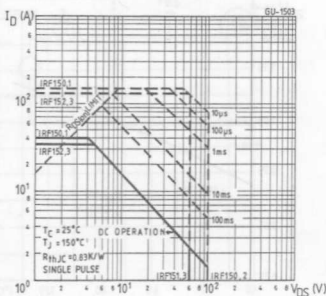

**Thermal impedance (standard package)**

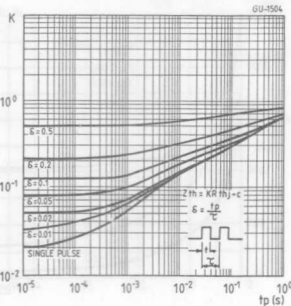

**Derating curve (standard package)**

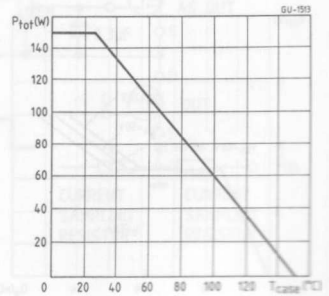

Output characteristics

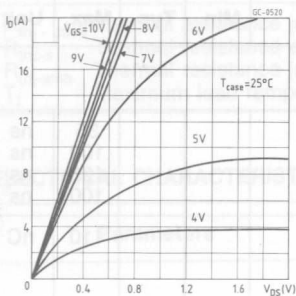

Output characteristics

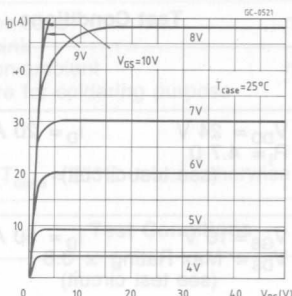

Transfer characteristics

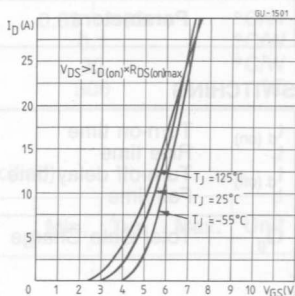

Transconductance

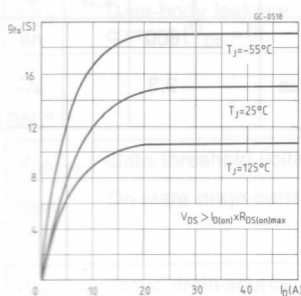

Static drain-source on resistance

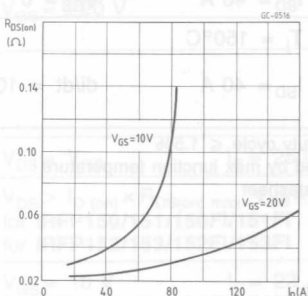

Maximum drain current vs temperature

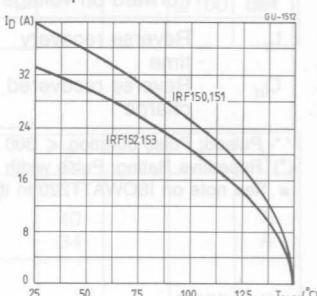

Gate charge vs gate-source voltage

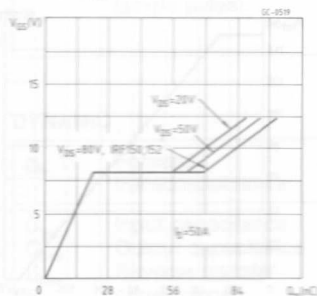

Capacitance variation

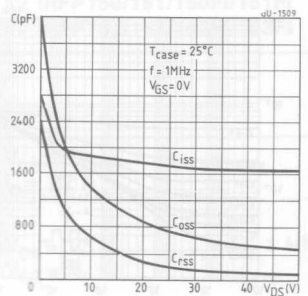

Normalized breakdown voltage vs temperature

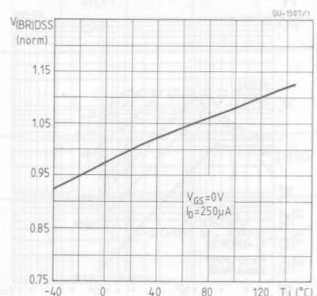

Normalized on resistance vs temperature

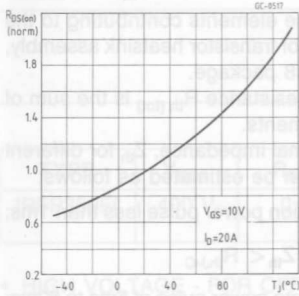

Source-drain diode forward characteristics

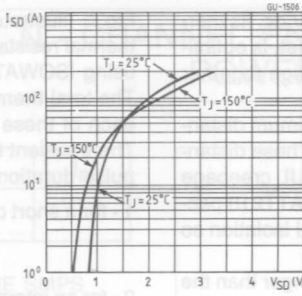

Unclamped inductive test circuit

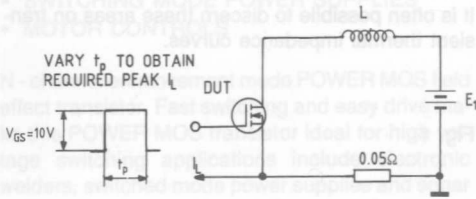

Unclamped inductive waveforms

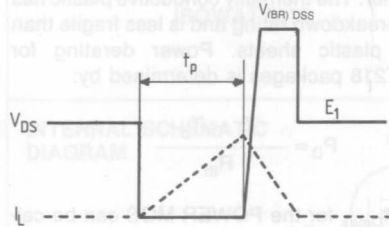

Switching times test circuit

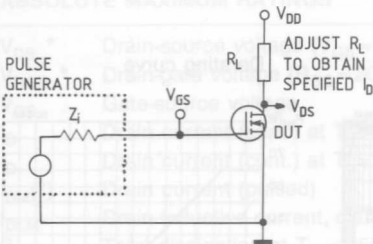

Gate charge test circuit

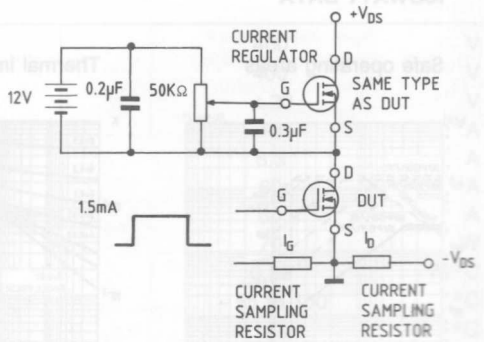

**ISOWATT218 PACKAGE CHARACTERISTICS AND APPLICATION.**

ISOWATT218 is fully isolated to 4000V dc. Its thermal impedance, given in the data sheet, is optimised to give efficient thermal conduction together with excellent electrical isolation.

The structure of the case ensures optimum distances between the pins and heatsink. These distances are in agreement with VDE and UL creepage and clearance standards. The ISOWATT218 package eliminates the need for external isolation so reducing fixing hardware.

The package is supplied with leads longer than the standard TO-218 to allow easy mounting on pcbs. Accurate moulding techniques used in manufacture assures consistent heat spreader-to-heatsink capacitance

ISOWATT218 thermal performance is better than that of the standard part, mounted with a 0.1mm mica washer. The thermally conductive plastic has a higher breakdown rating and is less fragile than mica or plastic sheets. Power derating for ISOWATT218 packages is determined by:

$$P_D = \frac{T_j - T_c}{R_{th}}$$

from this  $I_{Dmax}$  for the POWER MOS can be calculated:

$$I_{Dmax} \leq \sqrt{\frac{P_D}{R_{DS(on)} \text{ (at } 150^\circ\text{C)}}$$

**THERMAL IMPEDANCE OF ISOWATT218 PACKAGE**

Fig. 1 illustrates the elements contributing to the thermal resistance of transistor heatsink assembly, using ISOWATT218 package.

The total thermal resistance  $R_{th (tot)}$  is the sum of each of these elements.

The transient thermal impedance,  $Z_{th}$  for different pulse durations can be estimated as follows:

1 - for a short duration power pulse less than 1ms;

$$Z_{th} < R_{thJ-C}$$

2 - for an intermediate power pulse of 5ms to 50ms:

$$Z_{th} = R_{thJ-C}$$

3 - for long power pulses of the order of 500ms or greater:

$$Z_{th} = R_{thJ-C} + R_{thC-HS} + R_{thHS-amb}$$

It is often possible to discern these areas on transient thermal impedance curves.

Fig. 1

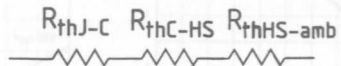

**ISOWATT DATA**

**Safe operating areas**

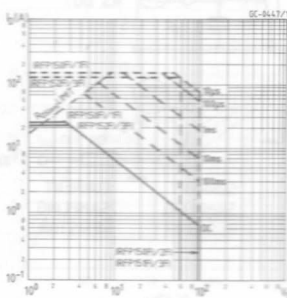

**Thermal impedance**

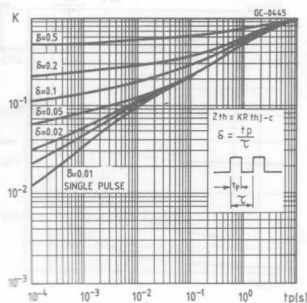

**Derating curve**

