

N - CHANNEL ENHANCEMENT MODE POWER MOS TRANSISTORS

TYPE	V _{DSS}	R _{DS(on)}	I _D
IRFZ40	50 V	0.028 Ω	35 A
IRFZ42	50 V	0.035 Ω	35 A

- VERY LOW R_{DS(on)}
- LOW DRIVE ENERGY FOR EASY DRIVE
- HIGH TRANSCONDUCTANCE /C_{rSS} RATIO

INDUSTRIAL APPLICATIONS:

- AUTOMOTIVE POWER ACTUATORS
- MOTOR CONTROLS
- INVERTERS

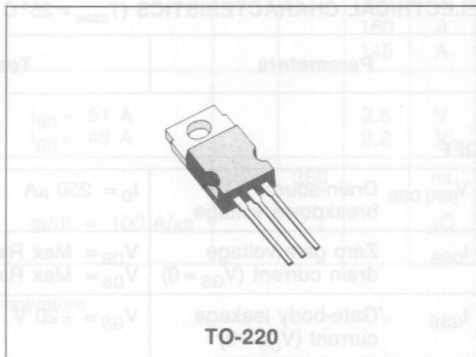

N - channel enhancement mode POWER MOS field effect transistors. Easy drive and very fast switching times make these POWER MOS transistors ideal for high speed switching circuits applications such as power actuators driving, motor drive including brushless motor, hydraulic actuators and many other in automotive and automatic guided vehicle applications. They also find use DC/DC converters and uninterruptible power supplies

INTERNAL SCHEMATIC DIAGRAM

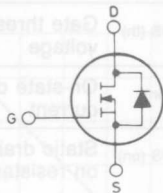

ABSOLUTE MAXIMUM RATINGS

	IRFZ40	IRFZ42	
V _{DS} *	50	50	V
V _{DGR} *	50	50	V
V _{GS}	± 20	± 20	V
I _D	35	35	A
I _D	32	29	A
I _{DM} (*)	160	145	A
I _{DLM}	160	145	A
P _{tot}		125	W
		1.2	W/°C
T _{stg}	-55 to 150		°C
T _j	150		°C

* T_i = 25°C to 125°C

(*) Repetitive Rating: Pulse width limited by max junction temperature

THERMAL DATA

$R_{thj-case}$	Thermal resistance junction-case	max	1.0	°C/W
R_{thc-s}	Thermal resistance case-sink	typ	0.5	°C/W
$R_{thj-amb}$	Thermal resistance junction-ambient	max	80	°C/W
T_I	Maximum lead temperature for soldering purpose		300	°C

ELECTRICAL CHARACTERISTICS ($T_{case} = 25^\circ\text{C}$ unless otherwise specified)

Parameters	Test Conditions	Min.	Typ.	Max.	Unit
------------	-----------------	------	------	------	------

OFF

$V_{(BR)DSS}$	Drain-source breakdown voltage	$I_D = 250 \mu\text{A}$	$V_{GS} = 0$	50	V
I_{DSS}	Zero gate voltage drain current ($V_{GS} = 0$)	$V_{DS} = \text{Max Rating}$ $V_{DS} = \text{Max Rating} \times 0.8$	$T_c = 125^\circ\text{C}$	250 1000	μA μA
I_{GSS}	Gate-body leakage current ($V_{DS} = 0$)	$V_{GS} = \pm 20 \text{ V}$		± 500	nA

ON **

$V_{GS(th)}$	Gate threshold voltage	$V_{DS} = V_{GS}$	$I_D = 250 \mu\text{A}$	2	4	V
$I_{D(on)}$	On-state drain current	$V_{DS} > I_{D(on)} \times R_{DS(on)max}$	$V_{GS} = 10 \text{ V}$	35		A
$R_{DS(on)}$	Static drain-source on resistance	$V_{GS} = 10 \text{ V}$ for IRFZ40 for IRFZ42	$I_D = 29 \text{ A}$		0.028 0.035	Ω Ω

DYNAMIC

g_{fs}^{**}	Forward transconductance	$V_{DS} > I_{D(on)} \times R_{DS(on)max}$ $I_D = 29 \text{ A}$		17		mho
C_{iss}	Input capacitance	$V_{DS} = 25 \text{ V}$	$f = 1 \text{ MHz}$		3000	pF
C_{oss}	Output capacitance	$V_{GS} = 0$			1200	pF
C_{rss}	Reverse transfer capacitance				400	pF

SWITCHING

$t_{d(on)}$	Turn-on time	$V_{DD} = 25 \text{ V}$	$I_D = 29 \text{ A}$		25	ns
t_r	Rise time	$Z_1 = 4.7 \Omega$			60	ns
$t_{d(off)}$	Turn-off delay time	(see test circuit)			70	ns
t_f	Fall time				25	ns
Q_g	Total gate charge	$V_{GS} = 10 \text{ V}$ $V_{DS} = \text{Max Rating} \times 0.8$	$I_D = 64 \text{ A}$		60	nC
		(see test circuit)				

ELECTRICAL CHARACTERISTICS (Continued)

Parameters	Test Conditions	Min.	Typ.	Max.	Unit
I_{SD} $I_{SDM}^{(*)}$	Source-drain current Source-drain current (pulsed) for IRFZ40 for IRFZ42			35 160 145	A A A
V_{SD}^{**}	Forward on voltage $V_{GS} = 0$ for IRFZ40 for IRFZ42			2.5 2.2	V V
t_{rr} Q_{rr}	Reverse recovery time Reverse recovered charge $T_j = 150^\circ\text{C}$ $I_{SD} = 51\text{ A}$ $di/dt = 100\text{ A}/\mu\text{s}$		350 2.1		ns μC

** Pulsed: Pulse duration $\leq 300\ \mu\text{s}$, duty cycle $\leq 1.5\%$

(*) Repetitive Rating: Pulse width limited by max junction temperature

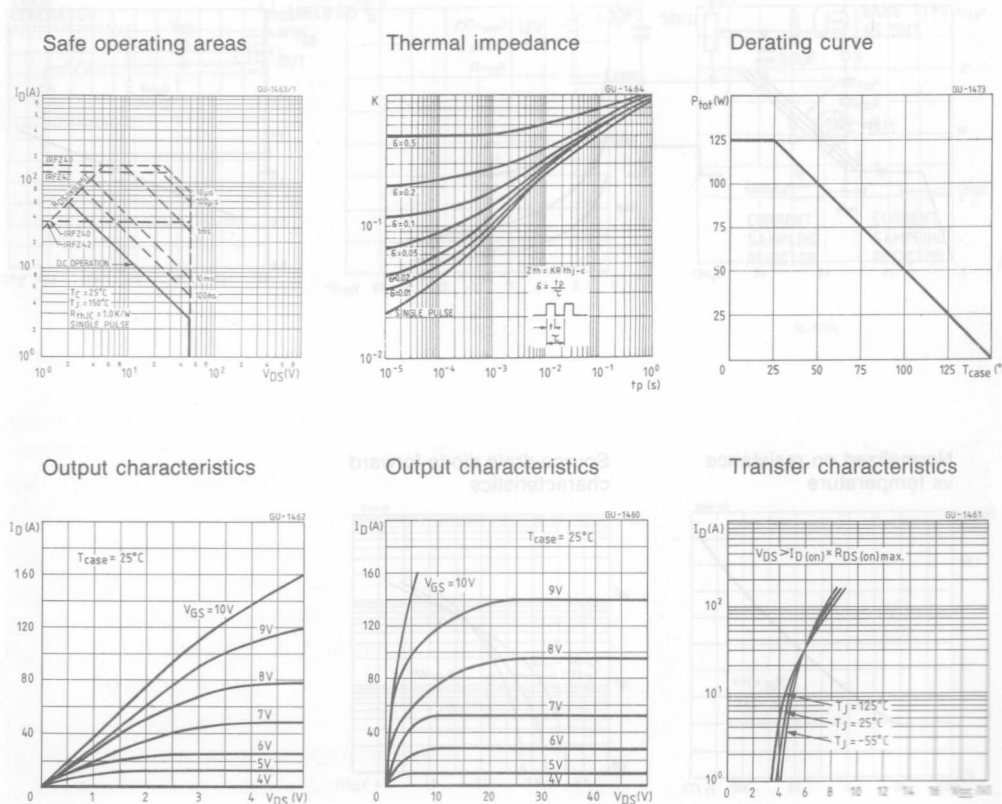

Transconductance

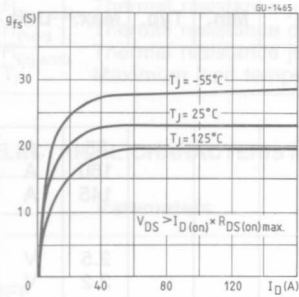

Static drain-source on resistance

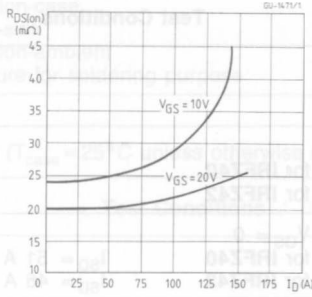

Maximum drain current vs temperature

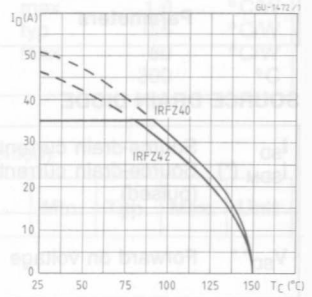

Gate charge vs gate-source voltage

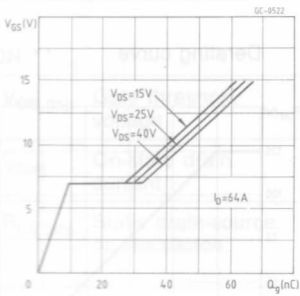

Capacitance variation

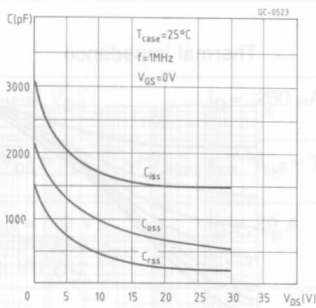

Normalized breakdown voltage vs temperature

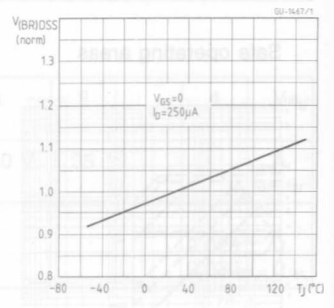

Normalized on resistance vs temperature

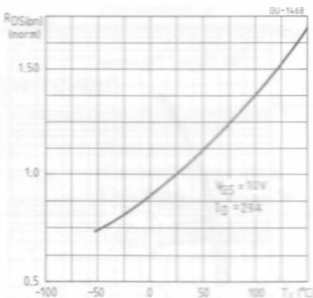

Source-drain diode forward characteristics

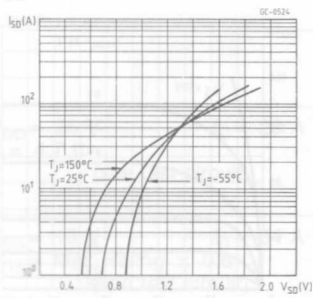

Clamped inductive test circuit

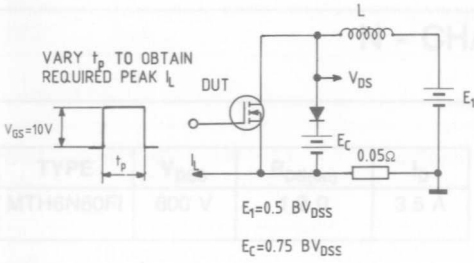

SC-0242

Clamped inductive waveforms

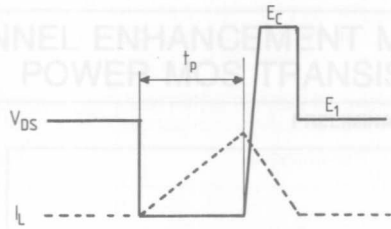

SC-0243

Switching times test circuit

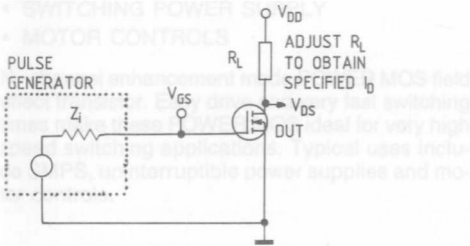

SC-0246

Gate charge test circuit

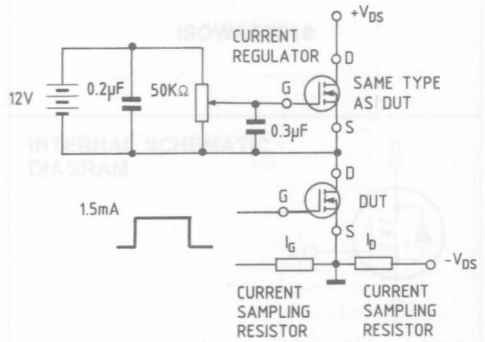

SC-0244

ABSOLUTE MAXIMUM RATINGS

V_{DS}	Drain-source voltage ($I_{DS} = 0$)	800	V
V_{DGS}	Drain-gate voltage ($R_{DS} = 20\text{ K}\Omega$)	800	V
V_{GS}	Gate-source voltage	± 20	V
I_D	Drain current (cont.) at $T_c = 25^\circ\text{C}$	9.5	A
I_{DM}	Drain current (pulsed)	14	A
P_{tot}	Total dissipation at $T_c < 25^\circ\text{C}$	40	W
	Dorating factor	0.92	W/°C
T_{stg}	Storage temperature	-65 to 150	°C
T_c	Max. operating junction temperature	150	°C