

# KSC5026M

## NPN Silicon Transistor

### Features

- High Voltage and High Reliability
- High Speed Switching
- Wide SOA

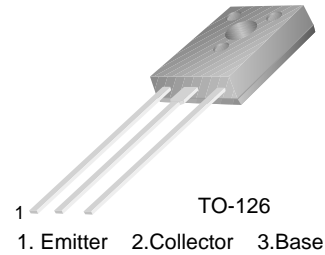

### Absolute Maximum Ratings $T_A = 25^\circ\text{C}$ unless otherwise noted

Symbol	Parameter	Value	Units
$V_{CBO}$	Collector-Base Voltage	1100	V
$V_{CEO}$	Collector-Emitter Voltage	800	V
$V_{EBO}$	Emitter-Base Voltage	7	V
$I_C$	Collector Current (DC)	1.5	A
$I_{CP}$	Collector Current (Pulse)	5	A
$I_B$	Base Current	0.8	A
$P_C$	Collector Dissipation ( $T_C=25^\circ\text{C}$ )	20	W
$T_J$	Junction Temperature	150	$^\circ\text{C}$
$T_{STG}$	Storage Temperature	- 55 to 150	$^\circ\text{C}$

### Package Marking and Ordering Information

Part Number	Marking	Package	Packing Method	Remarks
KSC5026MOS*	C5026M-O	TO-126	BULK	

\* The suffix "M" & "S" of FSID denotes TO126 package and the suffix "O" of FSID denotes  $h_{FE}$ -class

**Electrical Characteristics**  $T_A = 25^\circ\text{C}$  unless otherwise noted

Symbol	Parameter	Test Condition	Min.	Typ.	Max.	Units
$BV_{CBO}$	Collector-Base Breakdown Voltage	$I_C = 1\text{mA}, I_E = 0$	1100			V
$BV_{CEO}$	Collector-Emitter Breakdown Voltage	$I_C = 5\text{mA}, I_B = 0$	800			V
$BV_{EBO}$	Emitter-Base Breakdown Voltage	$I_E = 1\text{mA}, I_C = 0$	7			V
$V_{CEX(sus)}$	Collector-Emitter Sustaining Voltage	$I_C = 0.75\text{A},$ $I_{B1} = -I_{B2} = 0.15\text{A},$ $L = 5\text{mH}, \text{Clamped}$	800			V
$I_{CBO}$	Collector Cut-off Current	$V_{CB} = 800\text{V}, I_E = 0$			10	$\mu\text{A}$
$I_{EBO}$	Emitter Cut-off Current	$V_{EB} = 5\text{V}, I_C = 0$			10	$\mu\text{A}$
$h_{FE1}$ $h_{FE2}$	DC Current Gain	$V_{CE} = 5\text{V}, I_C = 0.1\text{A}$ $V_{CE} = 5\text{V}, I_C = 0.5\text{A}$	10 8		40	
$V_{CE(sat)}$	Collector-Emitter Saturation Voltage	$I_C = 0.75\text{A}, I_B = 0.15\text{A}$			2	V
$V_{BE(sat)}$	Base-Emitter Saturation Voltage	$I_C = 0.75\text{A}, I_B = 0.15\text{A}$			1.5	V
$C_{ob}$	Output Capacitance	$V_{CB} = 10\text{V}, I_E = 0, f = 1\text{MHz}$		35		pF
$f_T$	Current Gain Bandwidth Product	$V_{CE} = 10\text{V}, I_C = 0.1\text{A}$		15		MHz
$t_{ON}$	Turn On Time	$V_{CC} = 400\text{V}$			0.5	$\mu\text{s}$
$t_{STG}$	Storage Time	$I_C = 5I_{B1} = -2.5I_{B2} = 1\text{A}$			3	$\mu\text{s}$
$t_F$	Fall Time	$R_L = 400\Omega$			0.3	$\mu\text{s}$

 **$h_{FE}$  Classification**

Classification	N	R	O
$h_{FE1}$	10 ~ 20	15 ~ 30	20 ~ 40

Typical Performance Characteristics

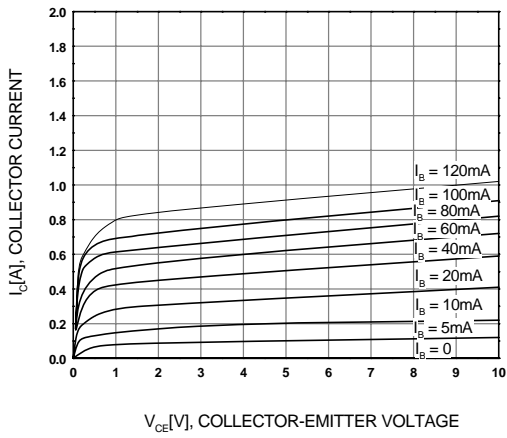

Figure 1. Static Characteristic

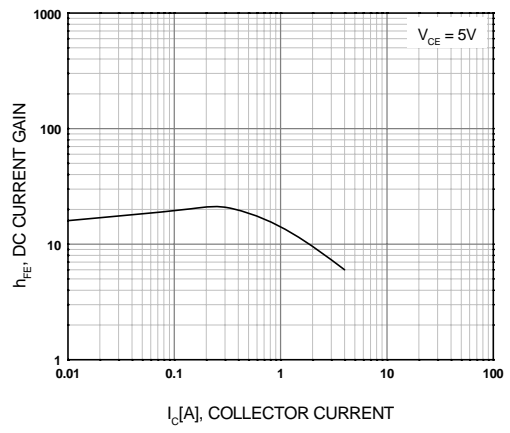

Figure 2. DC current Gain

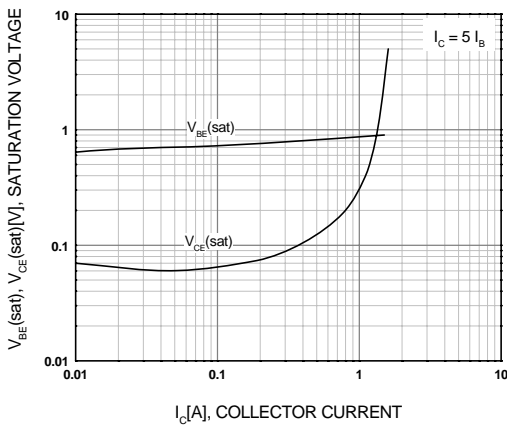

Figure 3. Base-Emitter Saturation Voltage  
Collector-Emitter Saturation Voltage

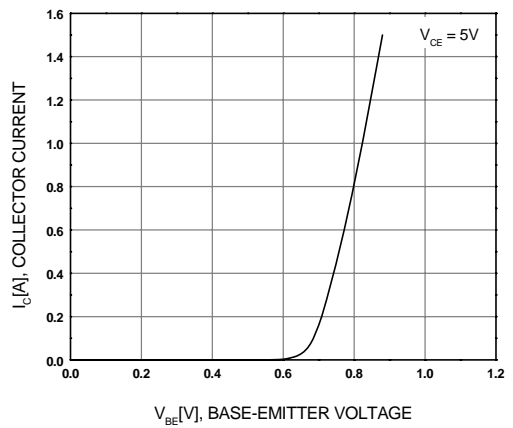

Figure 4. Base-Emitter On Voltage

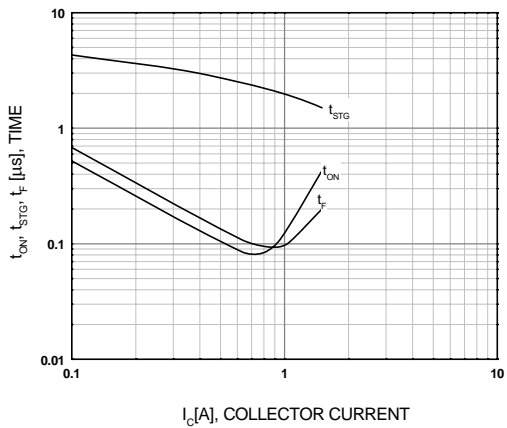

Figure 5. Switching Time

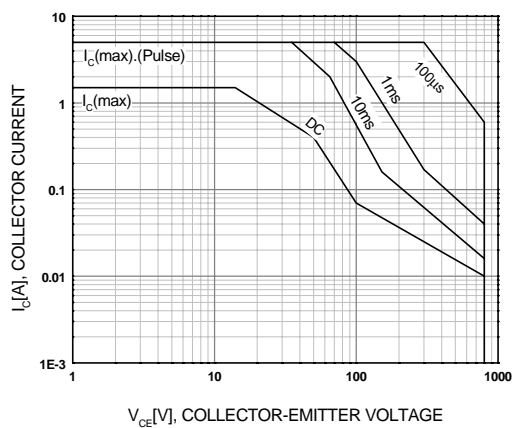

Figure 6. Safe Operating Area

Typical Performance Characteristics

(Continued)

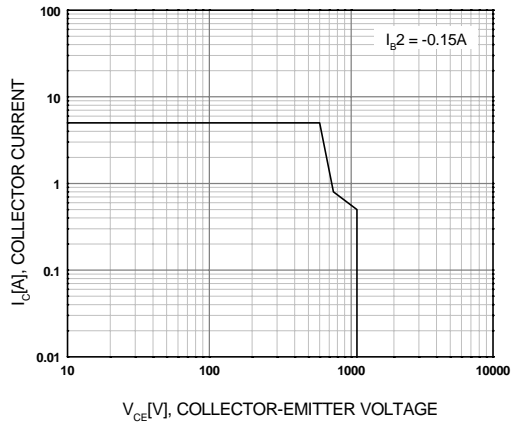

Figure 7. Reverse Bias Safe Operating Area

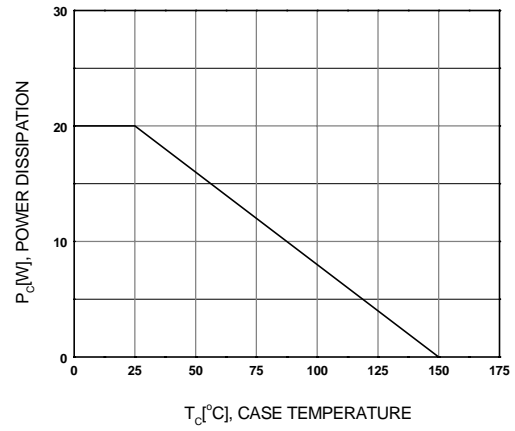
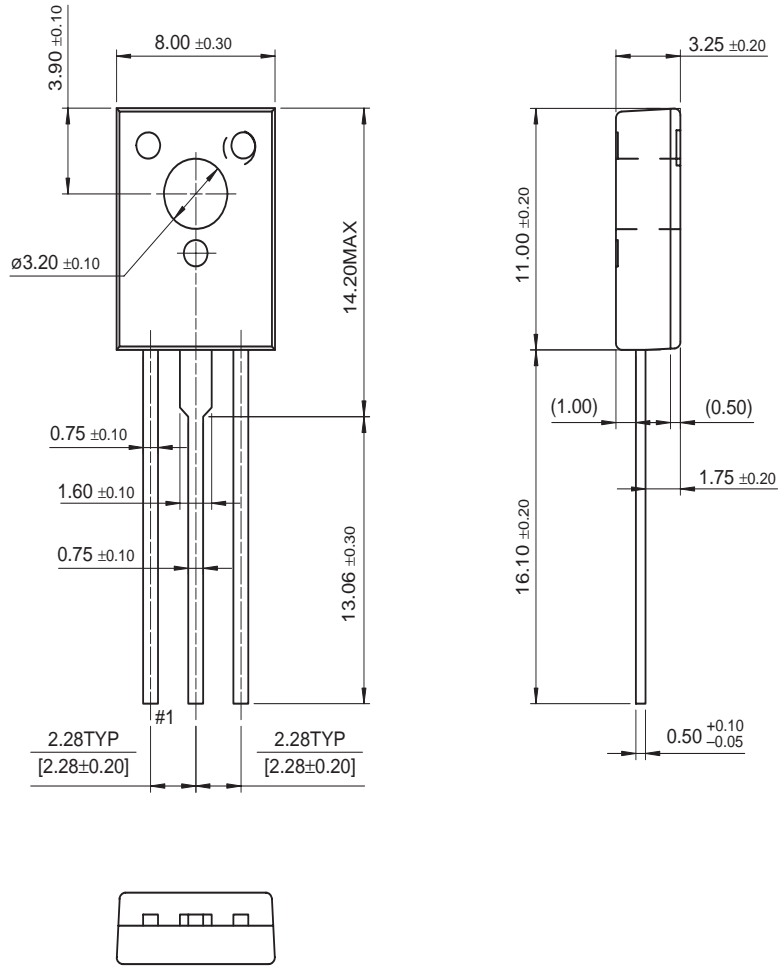

Figure 8. Power Derating

Physical Dimension

TO-126







Dimensions in Millimeters



**TRADEMARKS**

The following includes registered and unregistered trademarks and service marks, owned by Fairchild Semiconductor and/or its global subsidiaries, and is not intended to be an exhaustive list of all such trademarks.

AccuPower™	F-PFS™	Power-SPM™	The Power Franchise®
Auto-SPM™	FRFET®	PowerTrench®	The Right Technology for Your Success™
AX-CAP™*	Global Power Resource <sup>SM</sup>	PowerXS™	the <b>power</b> franchise™
Build it Now™	Green FPS™	Programmable Active Droop™	TinyBoost™
CorePLUS™	Green FPS™ e-Series™	QFET®	TinyBuck™
CorePOWER™	Gmax™	QS™	TinyCalc™
CROSSVOLT™	GTO™	Quiet Series™	TinyLogic®
CTL™	IntelliMAX™	RapidConfigure™	TINYOPTO™
Current Transfer Logic™	ISOPLANAR™	 ™	TinyPower™
DEUXPEED®	MegaBuck™	Saving our world, 1mW/W/kW at a time™	TinyPWM™
Dual Cool™	MICROCOUPLER™	SignalWise™	TinyWire™
EcoSPARK®	MicroFET™	SmartMax™	TriFault Detect™
EfficientMax™	MicroPak™	SMART START™	TRUECURRENT®*
ESBC™	MicroPak2™	SPM®	μSerDes™
 Fairchild®	MillerDrive™	STEALTH™	 SerDes™
Fairchild Semiconductor®	MotionMax™	SuperFET®	UHC®
FACT Quiet Series™	Motion-SPM™	SuperSOT™-3	Ultra FRFET™
FACT®	mWSaver™	SuperSOT™-6	UniFET™
FAST®	OptoHiT™	SuperSOT™-8	VCX™
FastvCore™	OPTOLOGIC®	SupreMOS®	VisualMax™
FETBench™	OPTOPLANAR®	SyncFET™	XS™
FlashWriter®*	 PDP SPM™	Sync-Lock™	
FPS™		 SYSTEM GENERAL®*	

\* Trademarks of System General Corporation, used under license by Fairchild Semiconductor.

**DISCLAIMER**

FAIRCHILD SEMICONDUCTOR RESERVES THE RIGHT TO MAKE CHANGES WITHOUT FURTHER NOTICE TO ANY PRODUCTS HEREIN TO IMPROVE RELIABILITY, FUNCTION, OR DESIGN. FAIRCHILD DOES NOT ASSUME ANY LIABILITY ARISING OUT OF THE APPLICATION OR USE OF ANY PRODUCT OR CIRCUIT DESCRIBED HEREIN; NEITHER DOES IT CONVEY ANY LICENSE UNDER ITS PATENT RIGHTS, NOR THE RIGHTS OF OTHERS. THESE SPECIFICATIONS DO NOT EXPAND THE TERMS OF FAIRCHILD'S WORLDWIDE TERMS AND CONDITIONS, SPECIFICALLY THE WARRANTY THEREIN, WHICH COVERS THESE PRODUCTS.

**LIFE SUPPORT POLICY**

FAIRCHILD'S PRODUCTS ARE NOT AUTHORIZED FOR USE AS CRITICAL COMPONENTS IN LIFE SUPPORT DEVICES OR SYSTEMS WITHOUT THE EXPRESS WRITTEN APPROVAL OF FAIRCHILD SEMICONDUCTOR CORPORATION.

As used herein:

1. Life support devices or systems are devices or systems which, (a) are intended for surgical implant into the body or (b) support or sustain life, and (c) whose failure to perform when properly used in accordance with instructions for use provided in the labeling, can be reasonably expected to result in a significant injury of the user.
2. A critical component in any component of a life support, device, or system whose failure to perform can be reasonably expected to cause the failure of the life support device or system, or to affect its safety or effectiveness.

**ANTI-COUNTERFEITING POLICY**

Fairchild Semiconductor Corporation's Anti-Counterfeiting Policy. Fairchild's Anti-Counterfeiting Policy is also stated on our external website, [www.fairchildsemi.com](http://www.fairchildsemi.com), under Sales Support.

Counterfeiting of semiconductor parts is a growing problem in the industry. All manufacturers of semiconductor products are experiencing counterfeiting of their parts. Customers who inadvertently purchase counterfeit parts experience many problems such as loss of brand reputation, substandard performance, failed applications, and increased cost of production and manufacturing delays. Fairchild is taking strong measures to protect ourselves and our customers from the proliferation of counterfeit parts. Fairchild strongly encourages customers to purchase Fairchild parts either directly from Fairchild or from Authorized Fairchild Distributors who are listed by country on our web page cited above. Products customers buy either from Fairchild directly or from Authorized Fairchild Distributors are genuine parts, have full traceability, meet Fairchild's quality standards for handling and storage and provide access to Fairchild's full range of up-to-date technical and product information. Fairchild and our Authorized Distributors will stand behind all warranties and will appropriately address any warranty issues that may arise. Fairchild will not provide any warranty coverage or other assistance for parts bought from Unauthorized Sources. Fairchild is committed to combat this global problem and encourage our customers to do their part in stopping this practice by buying direct or from authorized distributors.

**PRODUCT STATUS DEFINITIONS**

**Definition of Terms**

Datasheet Identification	Product Status	Definition
Advance Information	Formative / In Design	Datasheet contains the design specifications for product development. Specifications may change in any manner without notice.
Preliminary	First Production	Datasheet contains preliminary data; supplementary data will be published at a later date. Fairchild Semiconductor reserves the right to make changes at any time without notice to improve design.
No Identification Needed	Full Production	Datasheet contains final specifications. Fairchild Semiconductor reserves the right to make changes at any time without notice to improve the design.
Obsolete	Not In Production	Datasheet contains specifications on a product that is discontinued by Fairchild Semiconductor. The datasheet is for reference information only.