

CB TRANSCEIVER TX FINAL AMPLIFIER APPLICATION.  
HF TRANSCEIVER APPLICATION.

### FEATURES

- Recommended for Output Stage Application of AM 4W Transmitter.
- High Power Gain.
- Wide Area of Safe Operation.

### MAXIMUM RATINGS(Ta=25°C)

CHARACTERISTIC	SYMBOL	RATING	UNIT
Collector-Base Voltage	$V_{CBO}$	80	V
Collector-Emitter Voltage ( $R_{BE}=50\Omega$ )	$V_{CER}$	80	V
Emitter-Base Voltage	$V_{EBO}$	4	V
Collector Current	$I_C$	4	A
Emitter Current	$I_E$	-4	A
Collector Power Dissipation ( $T_c=25^\circ\text{C}$ )	$P_C$	10	W
Junction Temperature	$T_j$	150	°C
Storage Temperature Range	$T_{stg}$	-55~150	°C

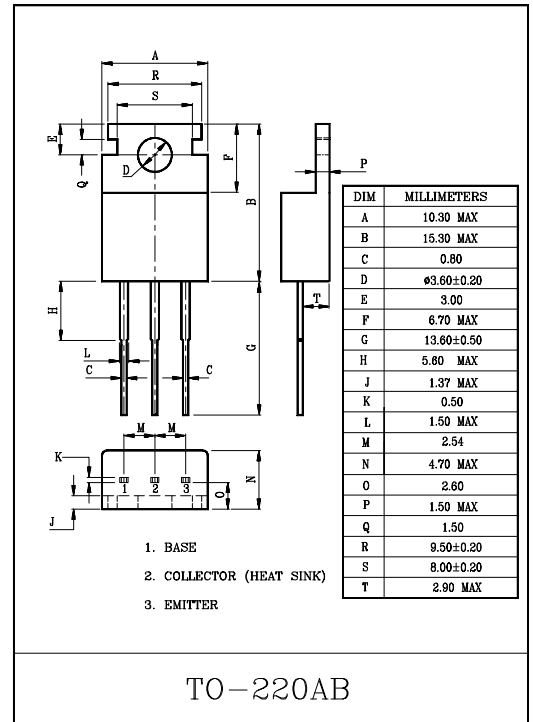

### ELECTRICAL CHARACTERISTICS (Ta=25°C)

CHARACTERISTIC	SYMBOL	TEST CONDITION	MIN.	TYP.	MAX.	UNIT
Collector Cut-off Current	$I_{CBO}$	$V_{CB}=30V, I_E=0$	-	-	10	$\mu\text{A}$
Breakdown Voltage	Collector-Emitter	$V_{(BR)CER}$ $I_C=10\text{mA}, R_{BE}=50\Omega$	80	-	-	V
	Emitter-Base	$V_{(BR)EBO}$ $I_E=1.0\text{mA}, I_C=0$	4	-	-	V
DC Current Gain	$h_{FE}$	$V_{CE}=5V, I_C=0.5A$	100	-	200	
Collector-Emitter Saturation Voltage	$V_{CE(sat)}$	$I_C=3A, I_B=0.3A$	-	-	1.5	V
Transition Frequency	$f_T$	$V_{CE}=5V, I_C=500\text{mA}$	100	-	-	MHz
Collector Output Capacitance	$C_{ob}$	$V_{CB}=10V, I_E=0, f=1\text{MHz}$	-	40	-	pF
Output Power (Fig.1)	$P_o$	$V_{CC}=12V, P_i=0.3W, f=27\text{MHz}$	4	-	-	W

Fig.1o P TEST CIRCUIT

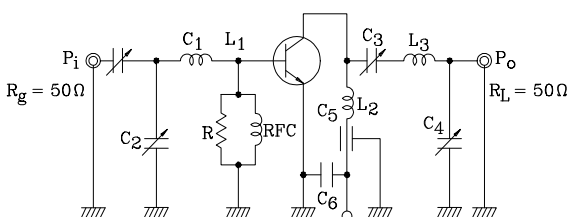

$C_1: \sim 100\text{pF}, C_2, C_3: \sim 150\text{pF}, C_4: \sim 300\text{pF}, C_5: 1000\text{pF}$

$C_6: 0.01\mu\text{F}, R: 250\Omega$

$L_1: 0.8\text{mm } \phi \text{ UEW, 7T, 8mm I.D. } L_2: 0.8\text{mm } \phi \text{ UEW, 5T, 8mm I.D.}$

$L_3: 0.8\text{mm } \phi \text{ UEW, 10T, 8mm I.D. RFC: } 0.35\text{mm } \phi \text{ UEW, 17T, 5mm I.D.}$

Fig.2 27MHz 4W OUTPUT AM TRANSCEIVER CIRCUIT

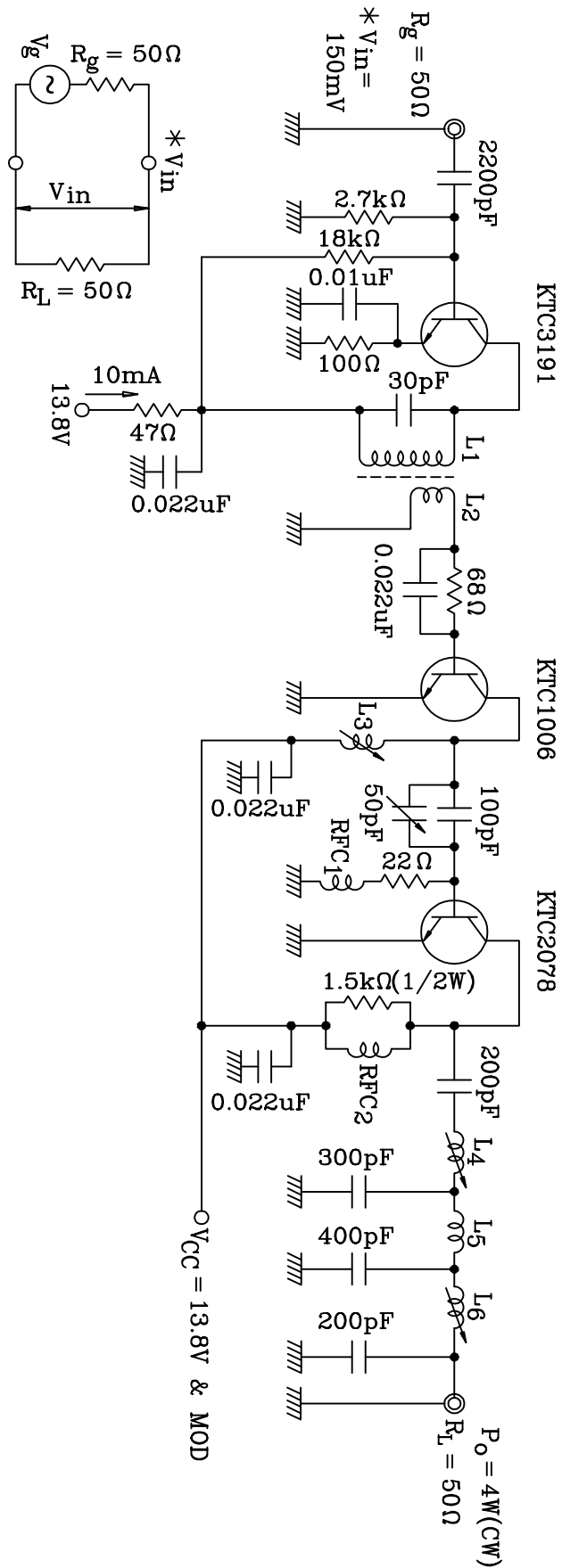

- L<sub>1</sub> : 4mm∅ BOBBIN WITH FERRITE CORE, 0.08mm∅ UEW, 8 TURNS
  - L<sub>2</sub> : 4mm∅ BOBBIN WITH FERRITE CORE, 0.08mm∅ UEW, 2 TURNS
  - L<sub>3, L<sub>6</sub></sub> : 6.5mm∅ BOBBIN WITH FERRITE CORE, 0.6mm∅ Sn PLATED COPPER WIRE 6 1/2 TURNS
  - L<sub>4</sub> : 6.5mm∅ BOBBIN WITH FERRITE CORE, 0.6mm∅ Sn PLATED COPPER WIRE 8 1/2 TURNS
  - L<sub>5</sub> : 0.6mm∅ Sn PLATED COPPER WIRE, 6.5mm I.D, 8 1/2 TURNS
  - RFC<sub>1</sub> : 4.7uH, 7BA-480k (TOKO)
  - RFC<sub>2</sub> : 0.2mm∅ UEW, 30 TURNS
- RESISTOR : 1/4W CARBON  
CAPACITOR : CERAMIC

$P_0 - P_i$

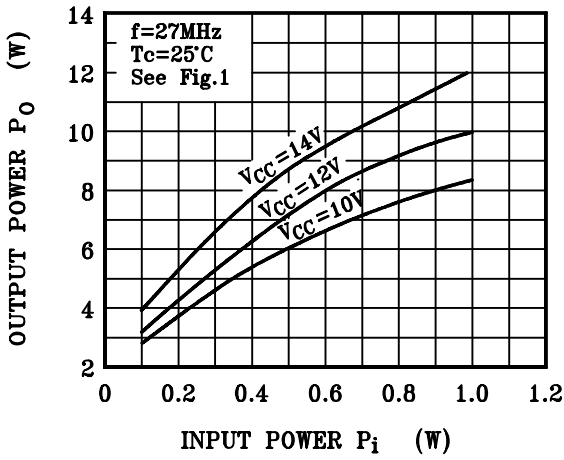

$P_0 - V_{CC}$

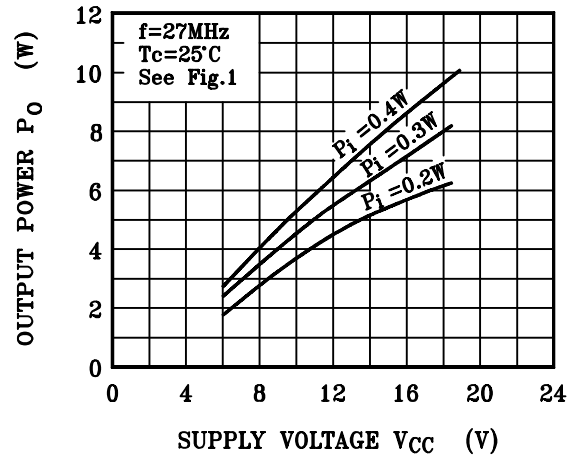

$h_{FE} - I_c$

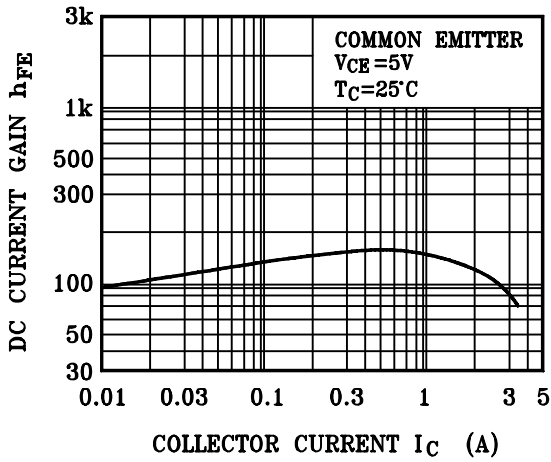

$f_T - I_c$

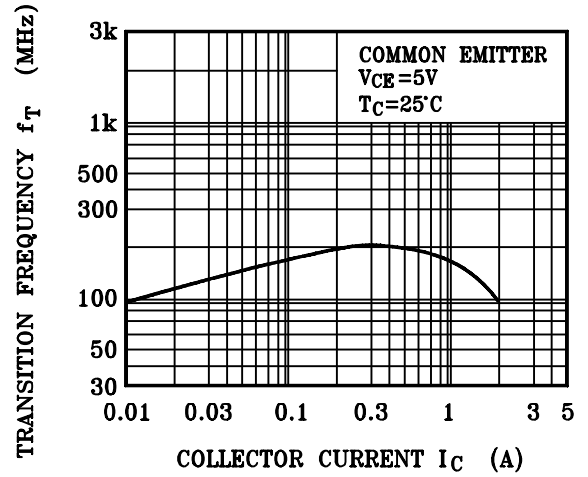

$C_{ob} - V_{CB}$

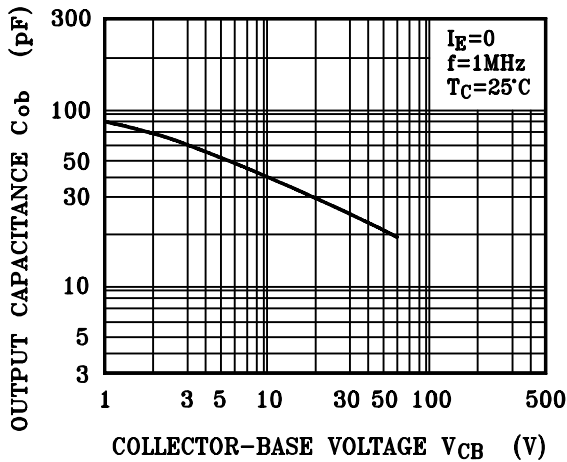

$P_c - T_a$

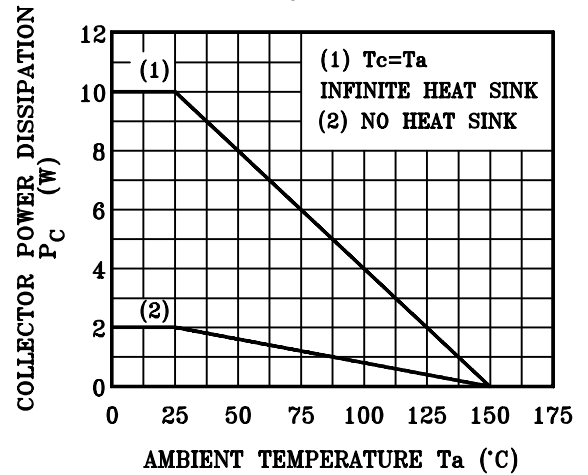

# KTC2078

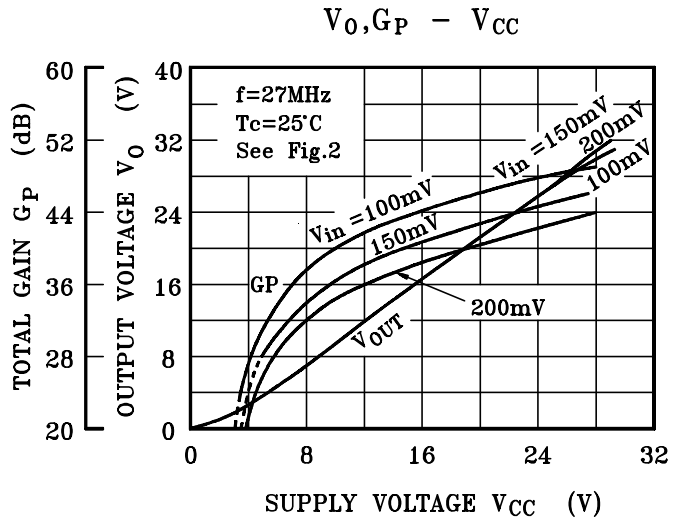
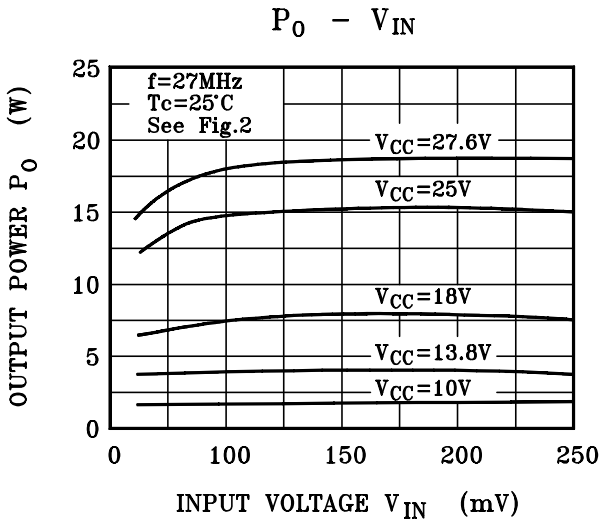

80% MODULATION SPECTRUM  
EMISSION LIMITATION (FCC)

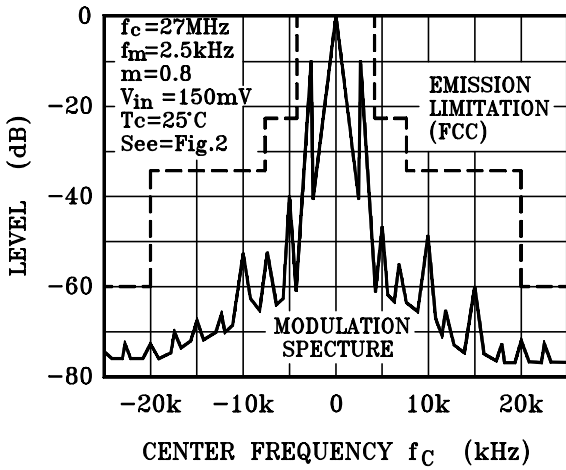

85% MODULATION SPECTRUM  
EMISSION LIMITATION (FCC)

