

HIGH FREQUENCY APPLICATION.
HF, VHF BAND AMPLIFIER APPLICATION.

FEATURES

- High Power Gain : $G_{pe}=30\text{dB(Typ.)}$ ($f=10.7\text{MHz}$).
- Recommended for FM IF, OSC Stage and AM CONV, IF Stage.

MAXIMUM RATINGS($T_a=25^\circ\text{C}$)

CHARACTERISTIC	SYMBOL	RATING	UNIT
Collector-Base Voltage	V_{CBO}	35	V
Collector-Emitter Voltage	V_{CEO}	30	V
Emitter-Base Voltage	V_{EBO}	4	V
Collector Current	I_C	50	mA
Emitter Current	I_E	-50	mA
Collector Power Dissipation	P_C	400	mW
Junction Temperature	T_j	150	$^\circ\text{C}$
Storage Temperature Range	T_{stg}	-55~150	$^\circ\text{C}$

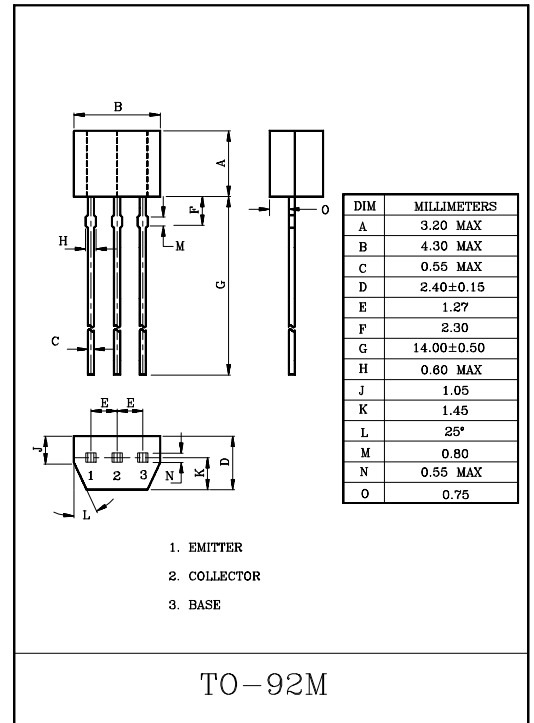

ELECTRICAL CHARACTERISTICS ($T_a=25^\circ\text{C}$)

CHARACTERISTIC	SYMBOL	TEST CONDITION	MIN.	TYP.	MAX.	UNIT
Collector Cut-off Current	I_{CBO}	$V_{CB}=35\text{V}, I_E=0$	-	-	0.1	μA
Emitter Cut-off Current	I_{EBO}	$V_{EB}=4\text{V}, I_C=0$	-	-	1.0	μA
DC Current Gain	$h_{FE}(\text{Note})$	$V_{CE}=12\text{V}, I_C=2\text{mA}$	40	-	240	
Collector-Emitter Saturation Voltage	$V_{CE(sat)}$	$I_C=10\text{mA}, I_B=1\text{mA}$	-	-	0.4	V
Base-Emitter Saturation Voltage	$V_{BE(sat)}$	$I_C=10\text{mA}, I_B=1\text{mA}$	-	-	1.0	V
Transition Frequency	f_T	$V_{CE}=10\text{V}, I_C=1\text{mA}$	100	-	-	MHz
Collector Output Capacitance	C_{ob}	$V_{CB}=10\text{V}, I_E=0, f=1\text{MHz}$	-	2.0	3.2	pF
Collector-Base Time Constant	$C_c \cdot r_{bb}$	$V_{CE}=10\text{V}, I_E=-1\text{mA}, f=30\text{MHz}$	10	-	50	pS
Power Gain	G_{pe}	$V_{CC}=6\text{V}, I_E=-1\text{mA}, f=10.7\text{MHz}$ (Fig.)	27	29	33	dB

Note : h_{FE} Classification R:40~80 , O:70~140 , Y:120~240

KTC3193

Fig. G_{pe} TEST CIRCUIT

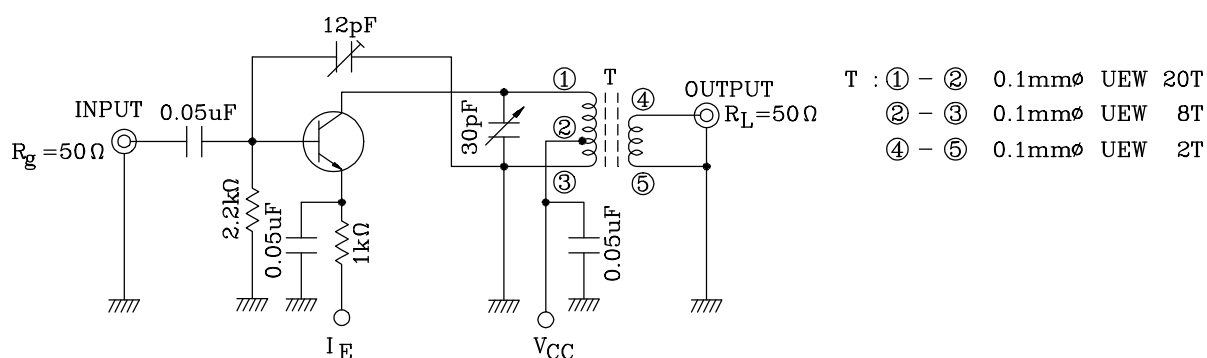

y PARAMETERS (Typ.)

(1) (COMMON EMITTER $f=455\text{kHz}$, $T_a=25^\circ\text{C}$)

CHARACTERISTIC	SYMBOL	KTC3193-R	KTC3193-O	KTC3193-Y	UNIT
Collector-Emitter Voltage	V_{CE}	6	6	6	V
Emitter Current	I_E	-1	-1	-1	mA
Input Conductance	g_{ie}	0.58	0.41	0.26	mS
Input Capacitance	C_{ie}	53	46	38	pF
Output Conductance	g_{oe}	1.9	2.7	4.8	μS
Output Capacitance	C_{oe}	2.6	2.8	3.6	pF
Forward Transfer Admittance	$ y_{fe} $	38	38	38	mS
Phase Angle of Forward Transfer Admittance	θ_{fe}	-0.79	-0.83	-0.92	$^\circ$
Reverse Transfer Admittance	$ y_{re} $	5.7	5.7	6.2	μS
Phase Angle of Reverse Transfer Admittance	θ_{re}	-90	-90	-90	$^\circ$

(2) (COMMON EMITTER $f=10.7\text{MHz}$, $T_a=25^\circ\text{C}$)

CHARACTERISTIC	SYMBOL	KTC3193-R	KTC3193-O	KTC3193-Y	UNIT
Collector-Emitter Voltage	V_{CE}	6	6	6	V
Emitter Current	I_E	-1	-1	-1	mA
Input Conductance	g_{ie}	1.04	0.85	0.65	mS
Input Capacitance	C_{ie}	49	43	36	pF
Output Conductance	g_{oe}	10	15	28	μS
Output Capacitance	C_{oe}	2.7	2.9	3.6	pF
Forward Transfer Admittance	$ y_{fe} $	37	37	37	mS
Phase Angle of Forward Transfer Admittance	θ_{fe}	-9.6	-10.4	-11.5	$^\circ$
Reverse Transfer Admittance	$ y_{re} $	120	120	140	μS
Phase Angle of Reverse Transfer Admittance	θ_{re}	-90	-90	-90	$^\circ$

KTC3193

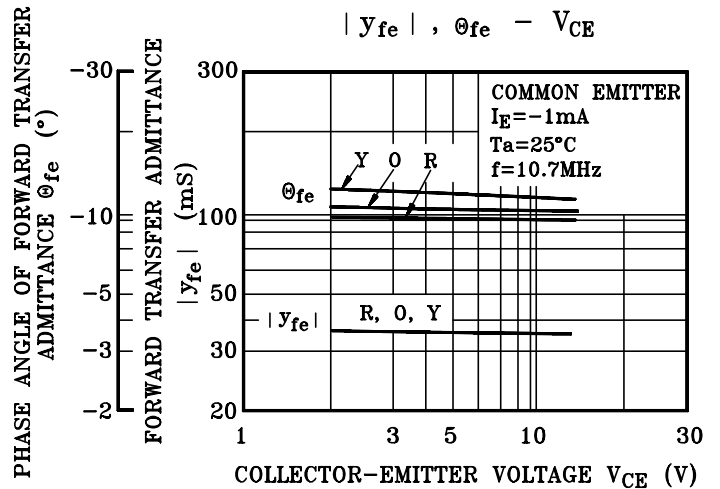
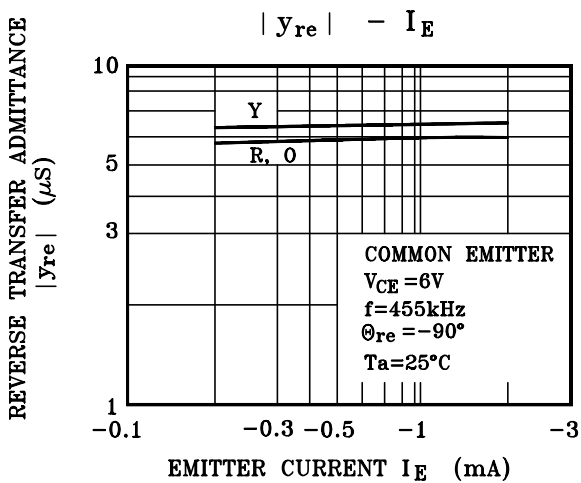
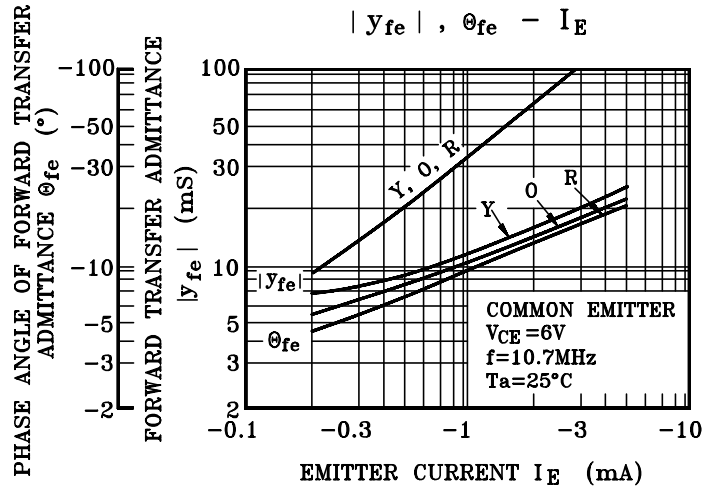
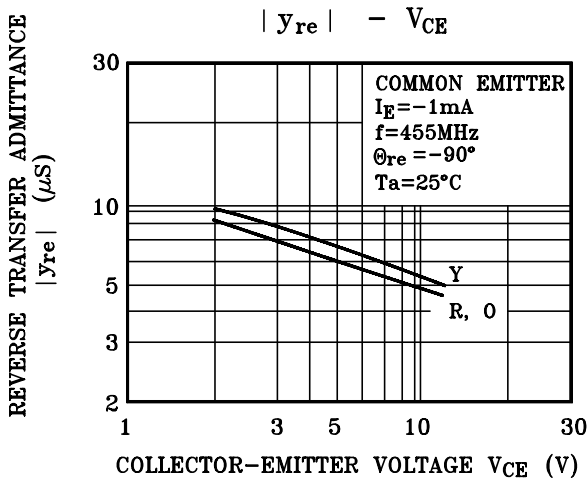
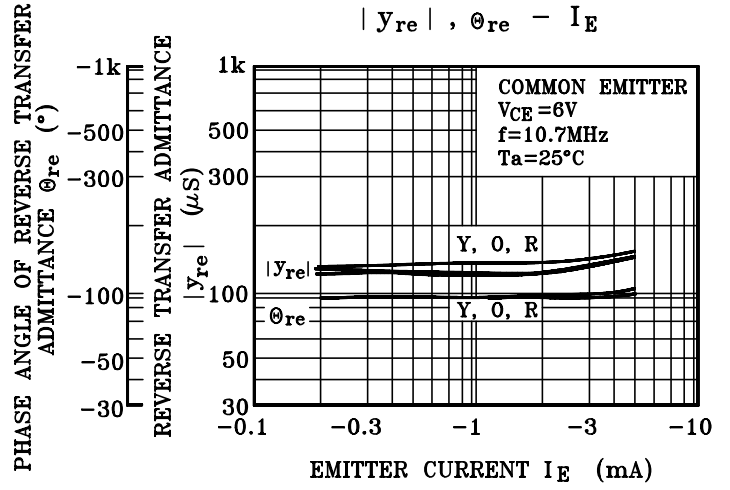
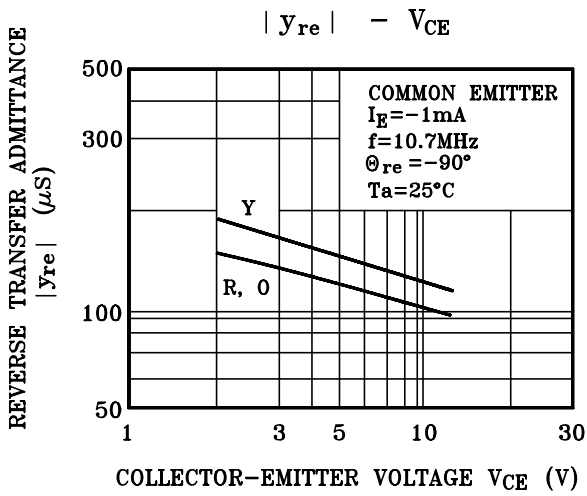

KTC3193

