

TOSHIBA Power Transistor Module
Silicon NPN&PNP Epitaxial Type (Darlington power transistor 4 in 1)

MP4005

High Power Switching Applications.

Hammer Drive, Pulse Motor Drive and Inductive Load Switching.

- Small package by full molding (SIP 10 pin)
- High collector power dissipation (4 devices operation)
: $P_T = 4 \text{ W}$ ($T_a = 25^\circ\text{C}$)
- High collector current: $I_C \text{ (DC)} = \pm 4 \text{ A}$ (max)
- High DC current gain: $h_{FE} = 2000$ (min) ($V_{CE} = \pm 2 \text{ V}$, $I_C = \pm 1 \text{ A}$)

Maximum Ratings ($T_a = 25^\circ\text{C}$)

Characteristics	Symbol	Rating		Unit
		NPN	PNP	
Collector-base voltage	V_{CBO}	100	-100	V
Collector-emitter voltage	V_{CEO}	80	-80	V
Emitter-base voltage	V_{EBO}	5	-5	V
Collector current	DC	I_C	4	A
	Pulse	I_{CP}	6	
Continuous base current	I_B	0.4	-0.4	A
Collector power dissipation (1 device operation)	P_C	2.0		W
Collector power dissipation (4 devices operation)	P_T	4.0		W
Junction temperature	T_j	150		$^\circ\text{C}$
Storage temperature range	T_{stg}	-55 to 150		$^\circ\text{C}$

Industrial Applications

Unit: mm

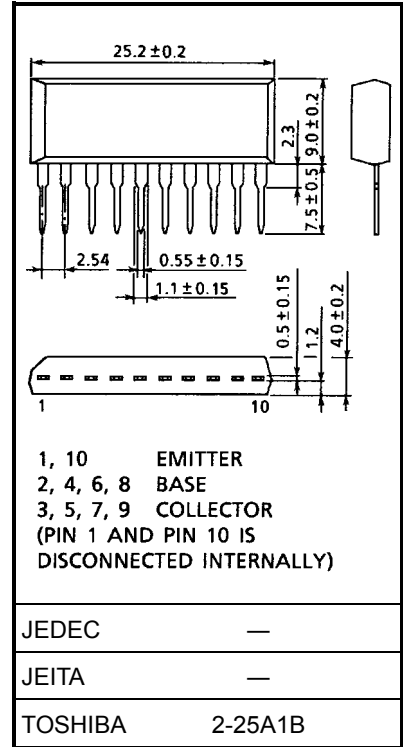

Weight: 2.1 g (typ.)

(Pin 1 and pin 10 is disconnected internally)

Array Configuration

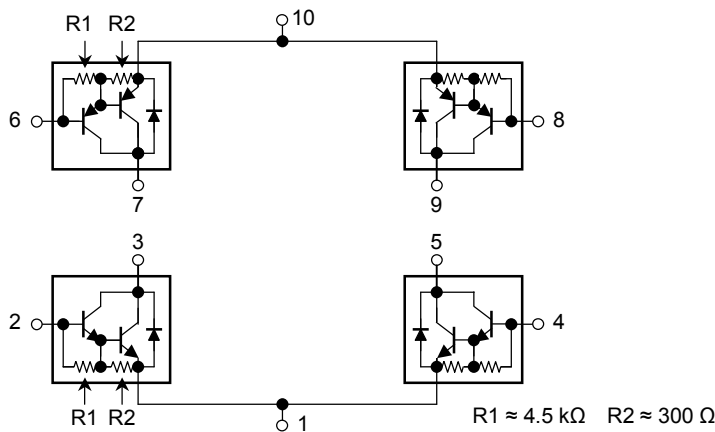

Thermal Characteristics

Characteristics	Symbol	Max	Unit
Thermal resistance of junction to ambient (4 devices operation, $T_a = 25^\circ\text{C}$)	$\Sigma R_{th(j-a)}$	31.3	$^\circ\text{C/W}$
Maximum lead temperature for soldering purposes (3.2 mm from case for 10 s)	T_L	260	$^\circ\text{C}$

Electrical Characteristics ($T_a = 25^\circ\text{C}$) (NPN transistor)

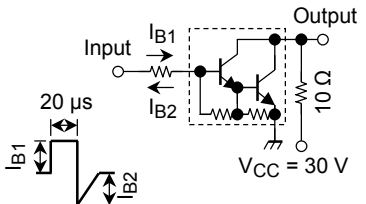
Characteristics		Symbol	Test Condition	Min	Typ.	Max	Unit
Collector cut-off current		I_{CBO}	$V_{CB} = 100\text{ V}, I_E = 0\text{ A}$	—	—	20	μA
Collector cut-off current		I_{CEO}	$V_{CE} = 80\text{ V}, I_B = 0\text{ A}$	—	—	20	μA
Emitter cut-off current		I_{EBO}	$V_{EB} = 5\text{ V}, I_C = 0\text{ A}$	0.5	—	2.5	mA
Collector-base breakdown voltage		$V_{(BR)CBO}$	$I_C = 1\text{ mA}, I_E = 0\text{ A}$	100	—	—	V
Collector-emitter breakdown voltage		$V_{(BR)CEO}$	$I_C = 10\text{ mA}, I_B = 0\text{ A}$	80	—	—	V
DC current gain		$h_{FE(1)}$	$V_{CE} = 2\text{ V}, I_C = 1\text{ A}$	2000	—	—	—
		$h_{FE(2)}$	$V_{CE} = 2\text{ V}, I_C = 3\text{ A}$	1000	—	—	
Saturation voltage	Collector-emitter	$V_{CE(sat)}$	$I_C = 3\text{ A}, I_B = 6\text{ mA}$	—	—	1.5	V
	Base-emitter	$V_{BE(sat)}$	$I_C = 3\text{ A}, I_B = 6\text{ mA}$	—	—	2.0	
Transition frequency		f_T	$V_{CE} = 2\text{ V}, I_C = 0.5\text{ A}$	—	60	—	MHz
Collector output capacitance		C_{ob}	$V_{CB} = 10\text{ V}, I_E = 0\text{ A}, f = 1\text{ MHz}$	—	30	—	pF
Switching time	Turn-on time	t_{on}	 <p>$I_{B1} = -I_{B2} = 6\text{ mA}, \text{duty cycle} \leq 1\%$</p>	—	0.2	—	μs
	Storage time	t_{stg}		—	1.5	—	
	Fall time	t_f		—	0.6	—	

Electrical Characteristics (Ta = 25°C) (PNP transistor)

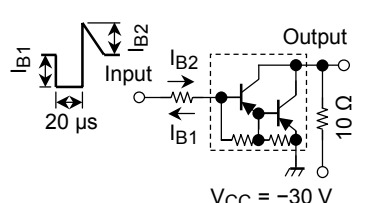
Characteristics		Symbol	Test Condition	Min	Typ.	Max	Unit
Collector cut-off current		I_{CBO}	$V_{CB} = -100\text{ V}, I_E = 0\text{ A}$	—	—	-20	μA
Collector cut-off current		I_{CEO}	$V_{CE} = -80\text{ V}, I_B = 0\text{ A}$	—	—	-20	μA
Emitter cut-off current		I_{EBO}	$V_{EB} = -5\text{ V}, I_C = 0\text{ A}$	-0.5	—	-2.5	mA
Collector-base breakdown voltage		$V_{(BR)CBO}$	$I_C = -1\text{ mA}, I_E = 0\text{ A}$	-100	—	—	V
Collector-emitter breakdown voltage		$V_{(BR)CEO}$	$I_C = -10\text{ mA}, I_B = 0\text{ A}$	-80	—	—	V
DC current gain		$h_{FE(1)}$	$V_{CE} = -2\text{ V}, I_C = -1\text{ A}$	2000	—	—	—
		$h_{FE(2)}$	$V_{CE} = -2\text{ V}, I_C = -3\text{ A}$	1000	—	—	
Saturation voltage	Collector-emitter	$V_{CE(sat)}$	$I_C = -3\text{ A}, I_B = -6\text{ mA}$	—	—	-1.5	V
	Base-emitter	$V_{BE(sat)}$	$I_C = -3\text{ A}, I_B = -6\text{ mA}$	—	—	-2.0	
Transition frequency		f_T	$V_{CE} = -2\text{ V}, I_C = -0.5\text{ A}$	—	40	—	MHz
Collector output capacitance		C_{ob}	$V_{CB} = -10\text{ V}, I_E = 0\text{ A}, f = 1\text{ MHz}$	—	55	—	pF
Switching time	Turn-on time	t_{on}	 <p style="text-align: center;">$V_{CC} = -30\text{ V}$</p> <p style="text-align: center;">$-I_{B1} = I_{B2} = 6\text{ mA}, \text{ duty cycle} \leq 1\%$</p>	—	0.15	—	μs
	Storage time	t_{stg}		—	0.80	—	
	Fall time	t_f		—	—	0.40	

(NPN transistor)

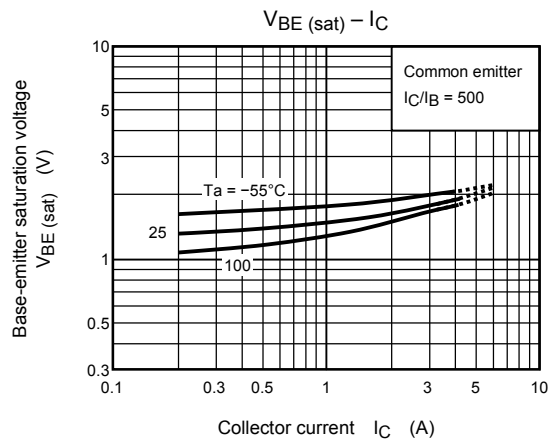
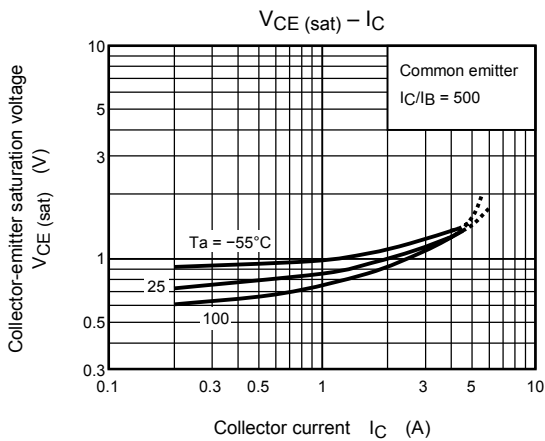
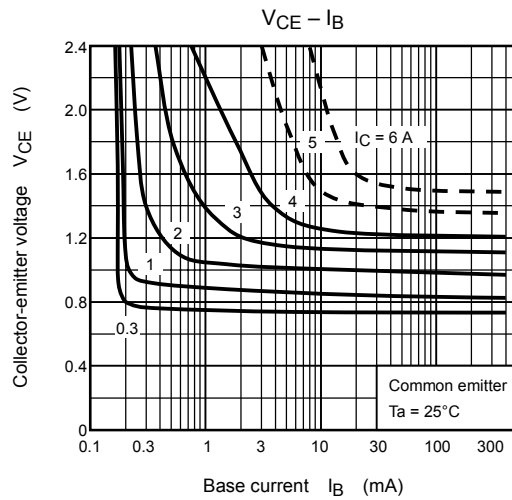
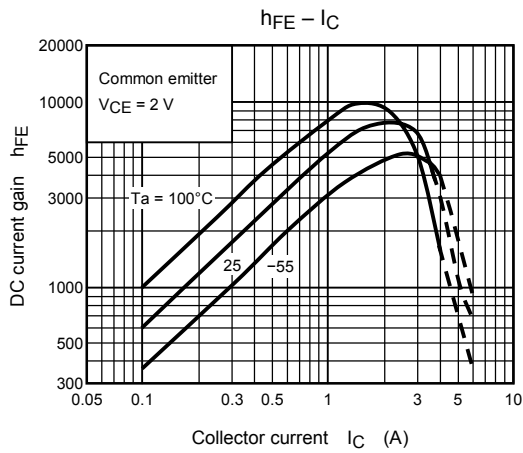
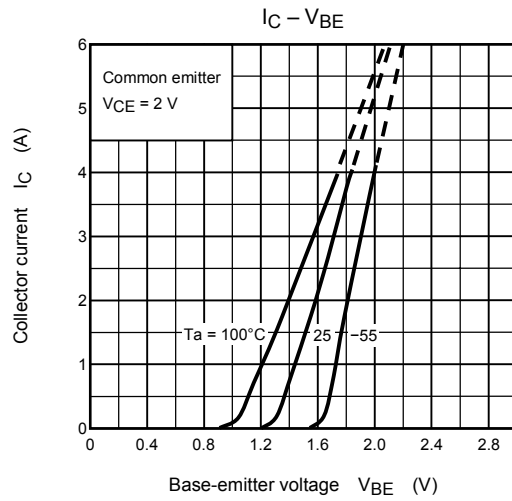
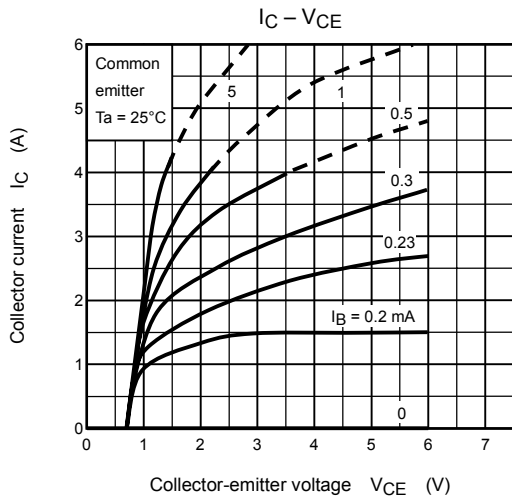

(PNP transistor)

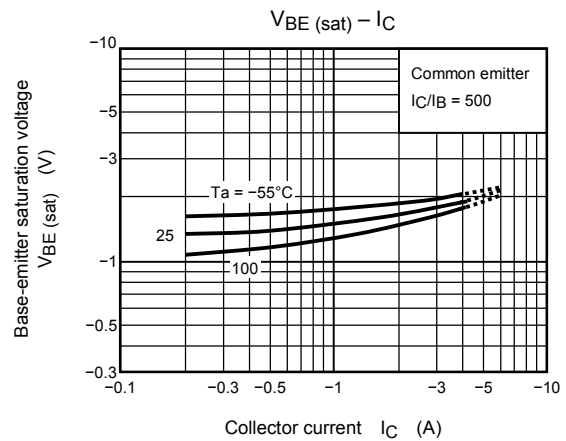
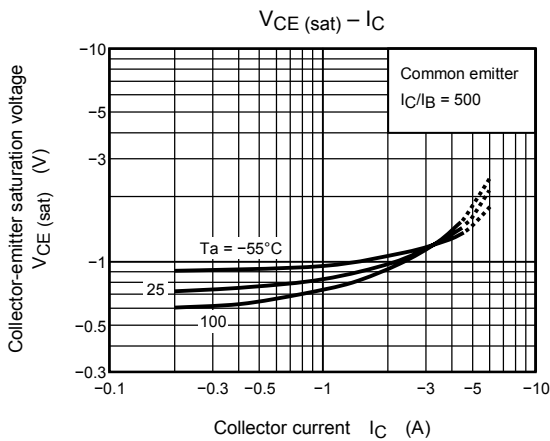
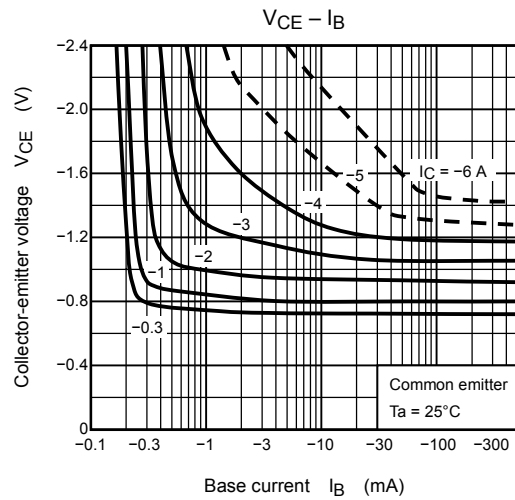
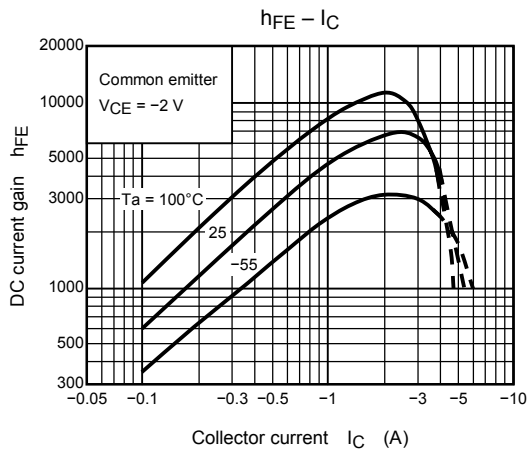
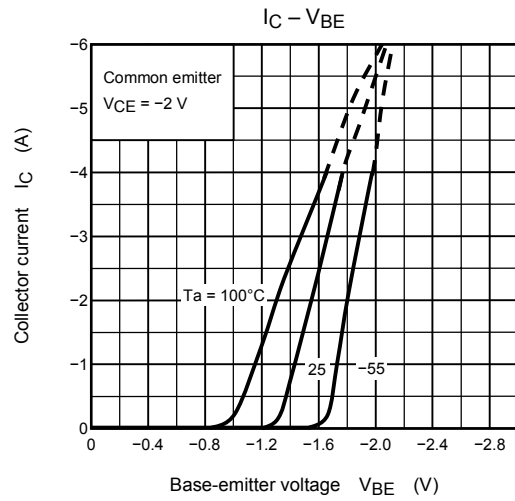
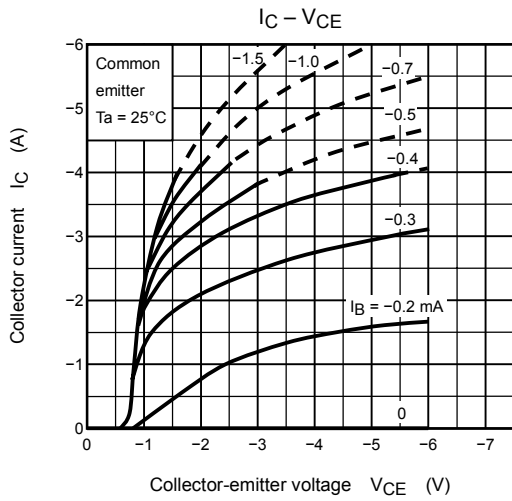

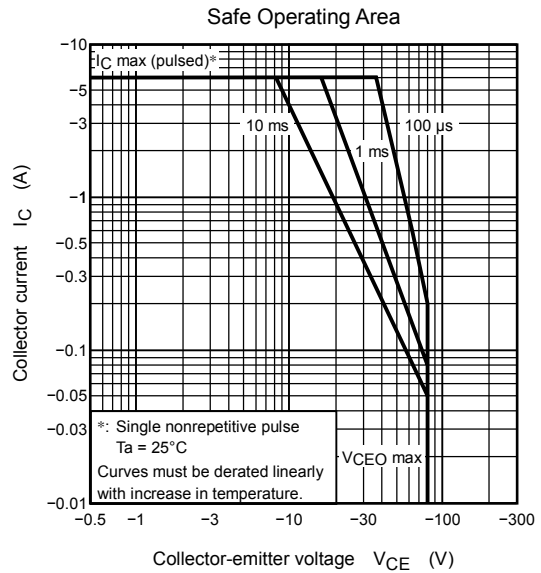
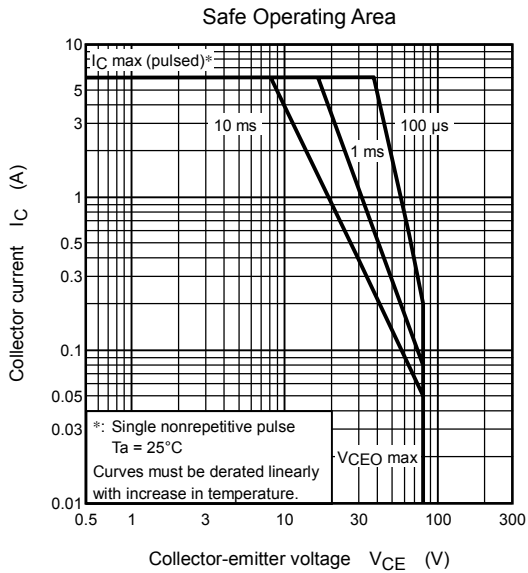
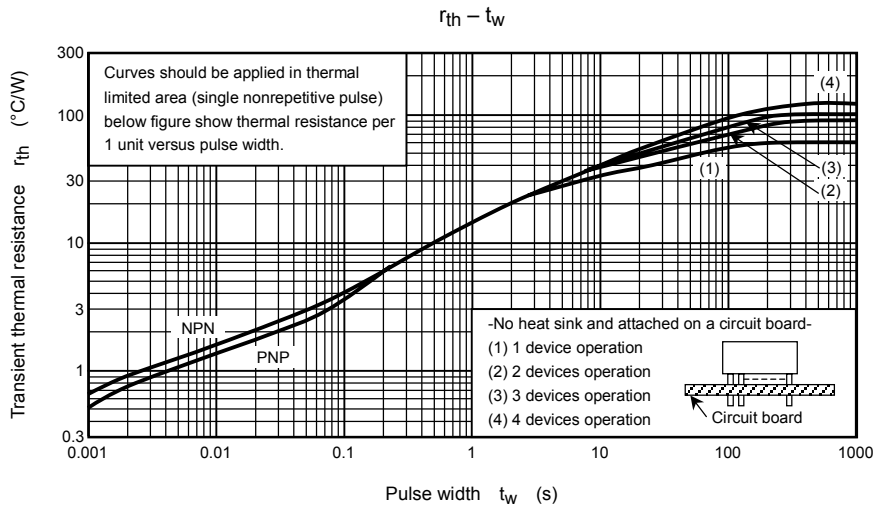

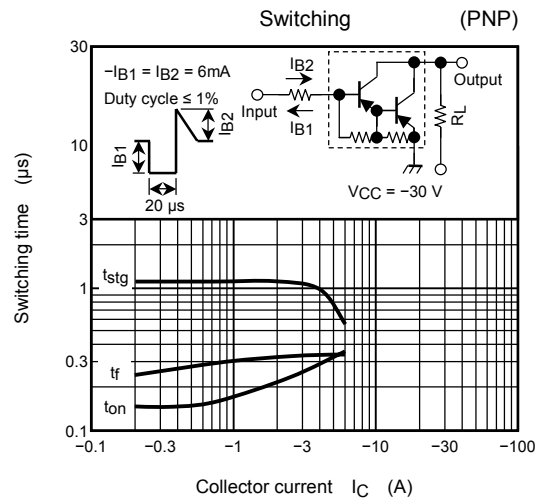
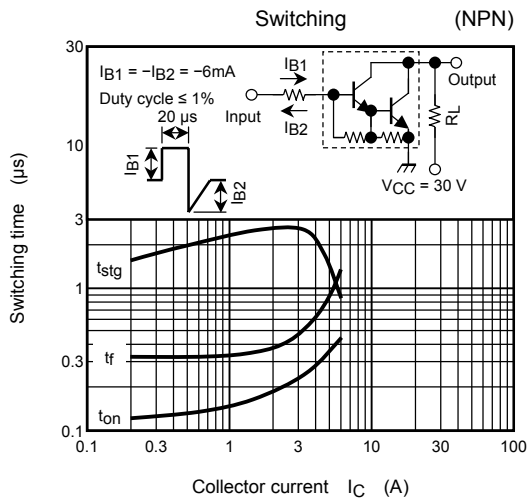
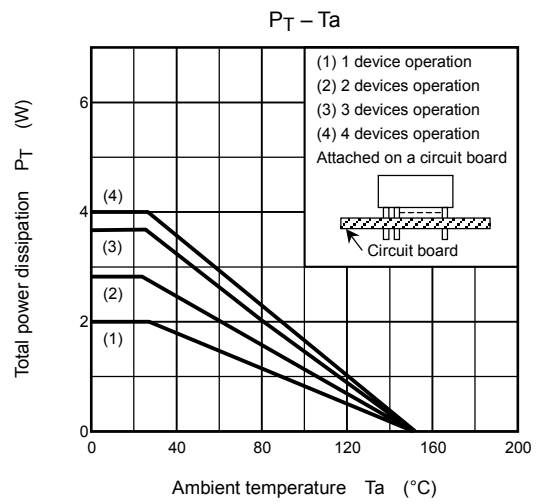
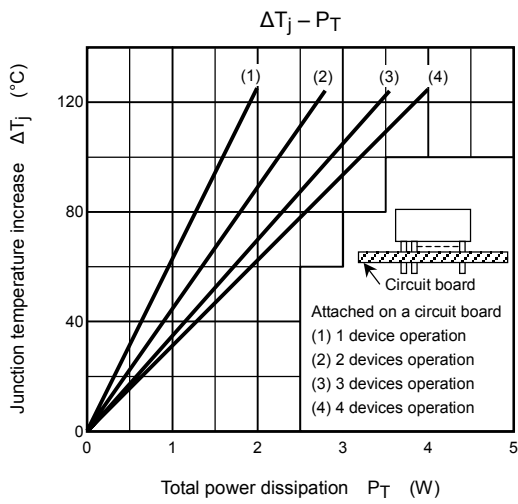

RESTRICTIONS ON PRODUCT USE

000707EAA

- TOSHIBA is continually working to improve the quality and reliability of its products. Nevertheless, semiconductor devices in general can malfunction or fail due to their inherent electrical sensitivity and vulnerability to physical stress. It is the responsibility of the buyer, when utilizing TOSHIBA products, to comply with the standards of safety in making a safe design for the entire system, and to avoid situations in which a malfunction or failure of such TOSHIBA products could cause loss of human life, bodily injury or damage to property.
In developing your designs, please ensure that TOSHIBA products are used within specified operating ranges as set forth in the most recent TOSHIBA products specifications. Also, please keep in mind the precautions and conditions set forth in the "Handling Guide for Semiconductor Devices," or "TOSHIBA Semiconductor Reliability Handbook" etc..
- The TOSHIBA products listed in this document are intended for usage in general electronics applications (computer, personal equipment, office equipment, measuring equipment, industrial robotics, domestic appliances, etc.). These TOSHIBA products are neither intended nor warranted for usage in equipment that requires extraordinarily high quality and/or reliability or a malfunction or failure of which may cause loss of human life or bodily injury ("Unintended Usage"). Unintended Usage include atomic energy control instruments, airplane or spaceship instruments, transportation instruments, traffic signal instruments, combustion control instruments, medical instruments, all types of safety devices, etc.. Unintended Usage of TOSHIBA products listed in this document shall be made at the customer's own risk.
- The information contained herein is presented only as a guide for the applications of our products. No responsibility is assumed by TOSHIBA CORPORATION for any infringements of intellectual property or other rights of the third parties which may result from its use. No license is granted by implication or otherwise under any intellectual property or other rights of TOSHIBA CORPORATION or others.
- The information contained herein is subject to change without notice.