

Dual Enhancement-Mode MOSFET (N- and P-Channel)

Product Summary

	V _{DS} (V)	r _{DS(on)} (Ω)	I _D (A)
N-Channel	30	0.065 @ V _{GS} = 10 V	± 3.9
		0.095 @ V _{GS} = 4.5 V	± 3.1
P-Channel	-30	0.085 @ V _{GS} = -10 V	± 3.5
		0.19 @ V _{GS} = -4.5 V	± 2.5

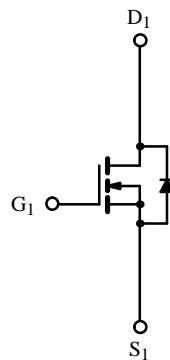
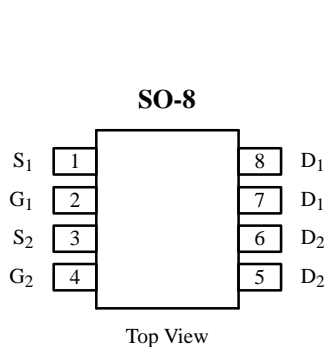

N-Channel MOSFET

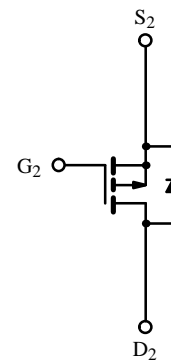

P-Channel MOSFET

Absolute Maximum Ratings (T_A = 25°C Unless Otherwise Noted)

Parameter	Symbol	N-Channel	P-Channel	Unit
Drain-Source Voltage	V _{DS}	30	-30	V
Gate-Source Voltage	V _{GS}	± 20	± 20	
Continuous Drain Current (T _J = 150°C) ^a	I _D	T _A = 25°C	± 3.9	A
		T _A = 70°C	± 3.1	
Pulsed Drain Current	I _{DM}	± 20	± 20	A
Continuous Source Current (Diode Conduction) ^a	I _S	1.7	-1.7	
Maximum Power Dissipation ^a	P _D	T _A = 25°C	2.0	W
		T _A = 70°C	1.3	
Operating Junction and Storage Temperature Range	T _J , T _{stg}	-55 to 150		°C

Thermal Resistance Ratings

Parameter	Symbol	N- or P-Channel	Unit
Maximum Junction-to-Ambient ^a	R _{thJA}	62.5	°C/W

Notes

a. Surface Mounted on FR4 Board, t ≤ 10 sec.

Subsequent updates to this data sheet may be obtained via facsimile by calling Siliconix FaxBack, 1-408-970-5600. Please request FaxBack document #1237.

Specifications ($T_J = 25^\circ\text{C}$ Unless Otherwise Noted)

Parameter	Symbol	Test Condition	Min	Typ	Max	Unit
Static						
Gate Threshold Voltage	$V_{GS(th)}$	$V_{DS} = V_{GS}, I_D = 250 \mu\text{A}$	N-Ch	1.0		V
		$V_{DS} = V_{GS}, I_D = -250 \mu\text{A}$	P-Ch	-1.0		
Gate-Body Leakage	I_{GSS}	$V_{DS} = 0 \text{ V}, V_{GS} = \pm 20 \text{ V}$	N-Ch		± 100	nA
Zero Gate Voltage Drain Current	I_{DSS}	$V_{DS} = 30 \text{ V}, V_{GS} = 0 \text{ V}$	N-Ch		1	μA
		$V_{DS} = -30 \text{ V}, V_{GS} = 0 \text{ V}$	P-Ch		-1	
		$V_{DS} = 30 \text{ V}, V_{GS} = 0 \text{ V}, T_J = 55^\circ\text{C}$	N-Ch		25	
		$V_{DS} = -30 \text{ V}, V_{GS} = 0 \text{ V}, T_J = 55^\circ\text{C}$	P-Ch		-25	
On-State Drain Current ^a	$I_{D(on)}$	$V_{DS} \geq 5 \text{ V}, V_{GS} = 10 \text{ V}$	N-Ch	15		A
		$V_{DS} \geq -5 \text{ V}, V_{GS} = -10 \text{ V}$	P-Ch	-15		
Drain-Source On-State Resistance ^a	$r_{DS(on)}$	$V_{GS} = 10 \text{ V}, I_D = 3.9 \text{ A}$	N-Ch		0.043	Ω
		$V_{GS} = -10 \text{ V}, I_D = 2.5 \text{ A}$	P-Ch		0.066	
		$V_{GS} = 4.5 \text{ V}, I_D = 3.1 \text{ A}$	N-Ch		0.075	
		$V_{GS} = -4.5 \text{ V}, I_D = 1.8 \text{ A}$	P-Ch		0.125	
Forward Transconductance ^a	g_{fs}	$V_{DS} = 15 \text{ V}, I_D = 3.9 \text{ A}$	N-Ch		7	S
		$V_{DS} = -15 \text{ V}, I_D = -2.5 \text{ A}$	P-Ch		5	
Diode Forward Voltage ^a	V_{SD}	$I_S = 1.7 \text{ A}, V_{GS} = 0 \text{ V}$	N-Ch		0.8	V
		$I_S = -1.7 \text{ A}, V_{GS} = 0 \text{ V}$	P-Ch		-0.8	
Dynamic^b						
Total Gate Charge	Q_g	N-Channel $V_{DS} = 10 \text{ V}, V_{GS} = 10 \text{ V}, I_D = 3.9 \text{ A}$ P-Channel $V_{DS} = -10 \text{ V}, V_{GS} = -10 \text{ V}, I_D = -2.5 \text{ A}$	N-Ch		9.8	nC
Gate-Source Charge	Q_{gs}		N-Ch		2.1	
			P-Ch		1.9	
Gate-Drain Charge	Q_{gd}	N-Ch		1.6		
		P-Ch		1.3		
Turn-On Delay Time	$t_{d(on)}$	N-Channel $V_{DD} = 10 \text{ V}, R_L = 10 \Omega$ $I_D \cong 1 \text{ A}, V_{GEN} = 10 \text{ V}, R_G = 6 \Omega$ P-Channel $V_{DD} = -10 \text{ V}, R_L = 10 \Omega$ $I_D \cong -1 \text{ A}, V_{GEN} = -10 \text{ V}, R_G = 6 \Omega$	N-Ch		9	ns
Rise Time	t_r		N-Ch		6	
			P-Ch		9	
Turn-Off Delay Time	$t_{d(off)}$		N-Ch		18	
			P-Ch		14	
Fall Time	t_f		N-Ch		6	
			P-Ch		8	
Source-Drain Reverse Recovery Time	t_{rr}		$I_F = 1.7 \text{ A}, di/dt = 100 \text{ A}/\mu\text{s}$	N-Ch		
		$I_F = -1.7 \text{ A}, di/dt = 100 \text{ A}/\mu\text{s}$	P-Ch		50	

Notes

- a. Pulse test; pulse width $\leq 300 \mu\text{s}$, duty cycle $\leq 2\%$.
 b. Guaranteed by design, not subject to production testing.

Typical Characteristics (25°C Unless Noted)

N-Channel

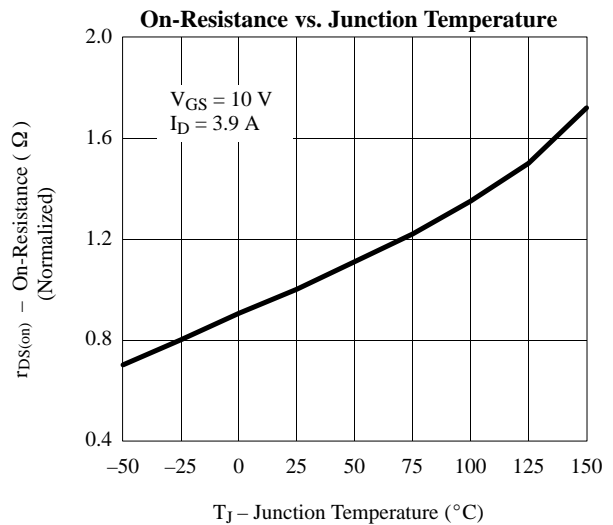
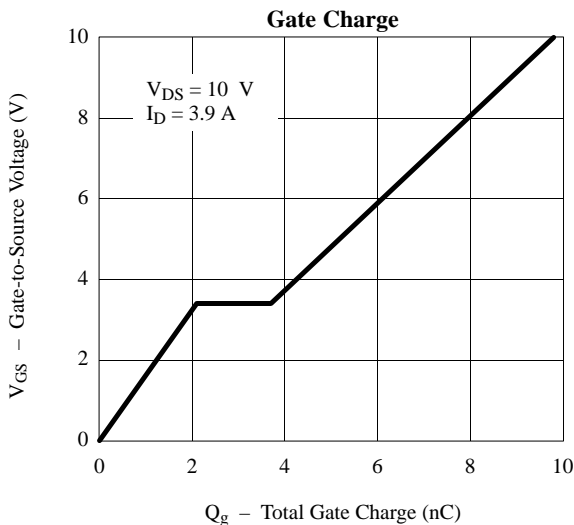
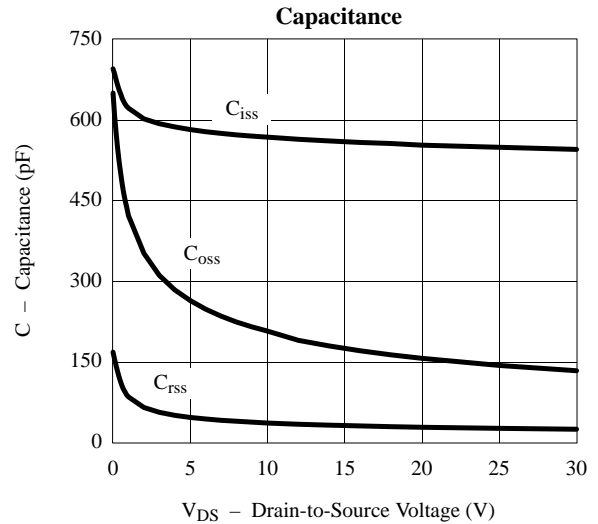
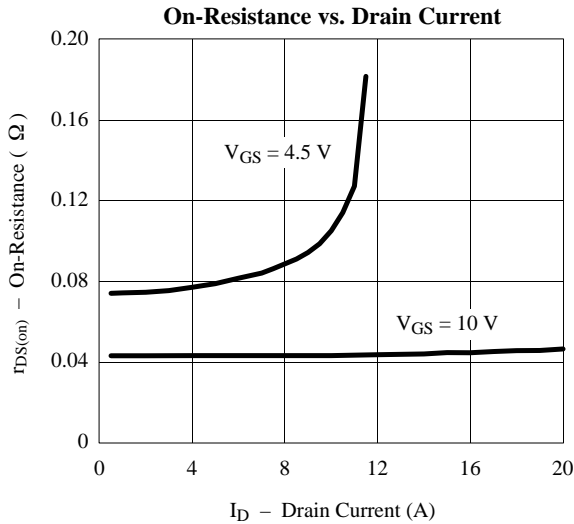
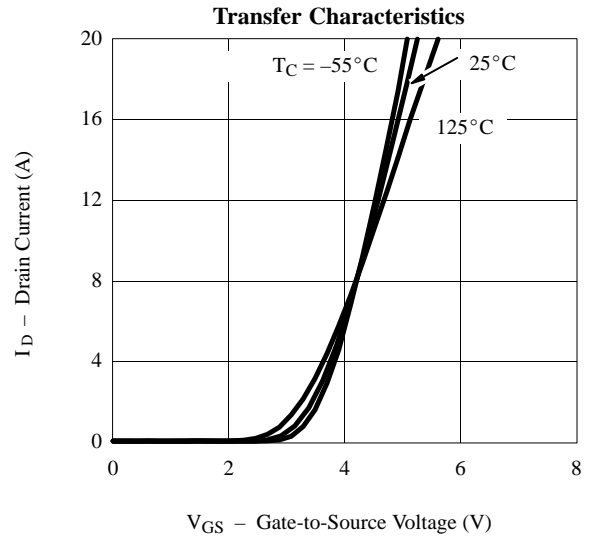
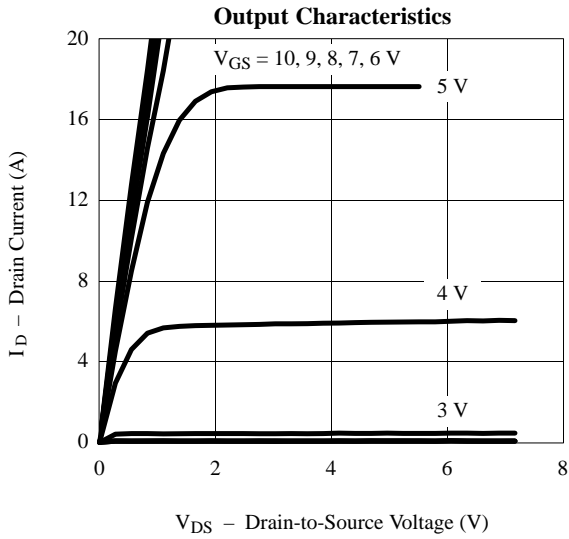

Typical Characteristics (25°C Unless Noted)

N-Channel

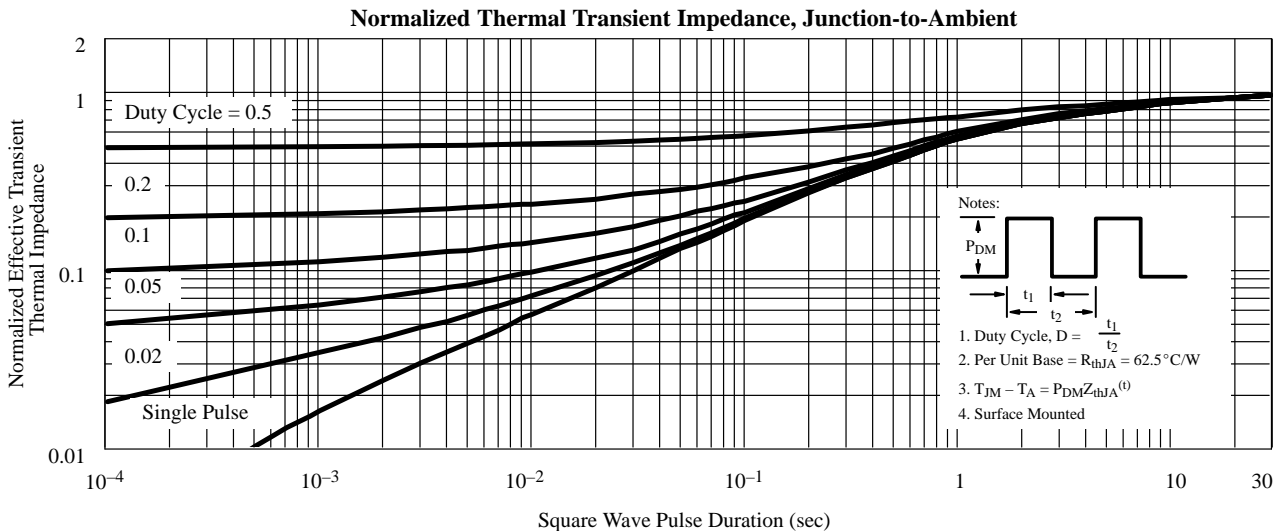
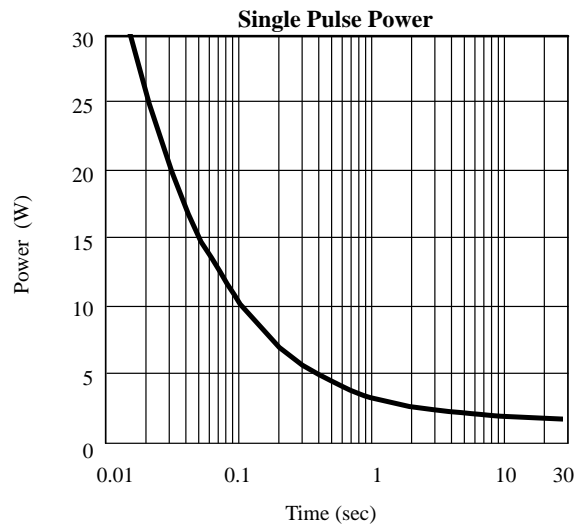
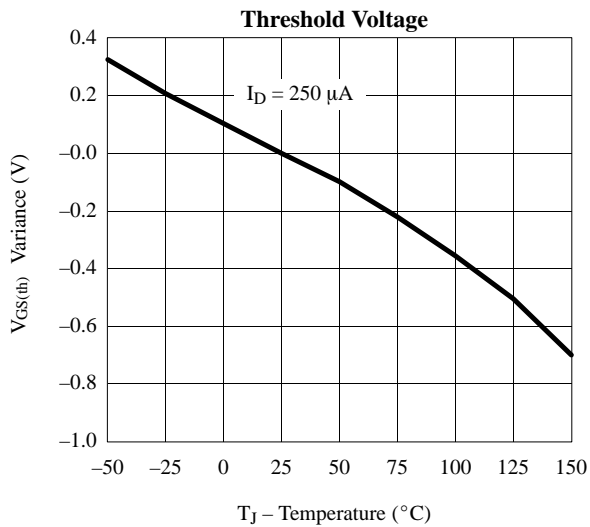
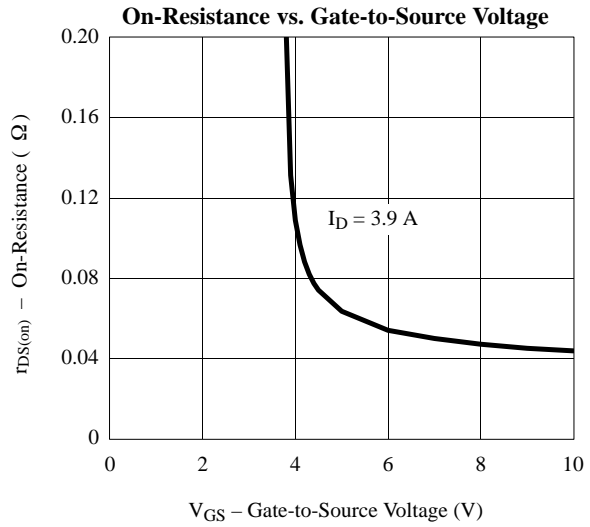
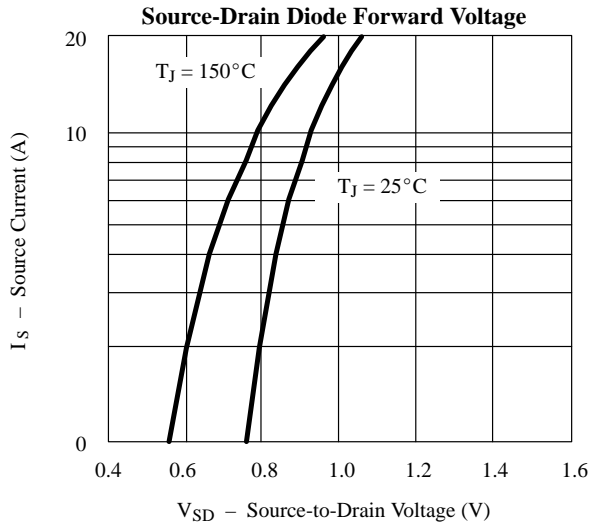

Typical Characteristics (25°C Unless Noted)

P-Channel

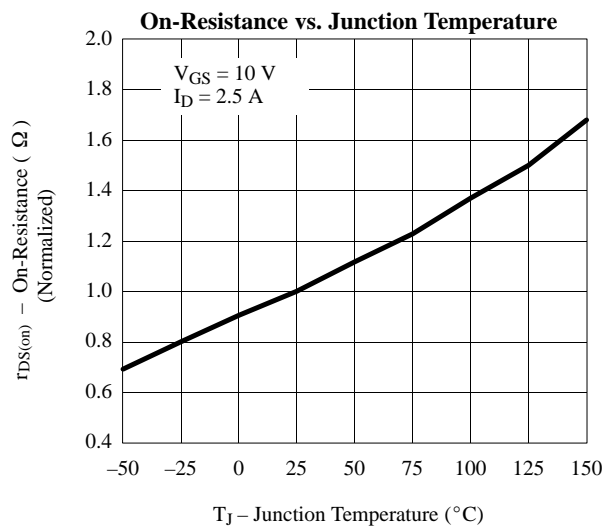
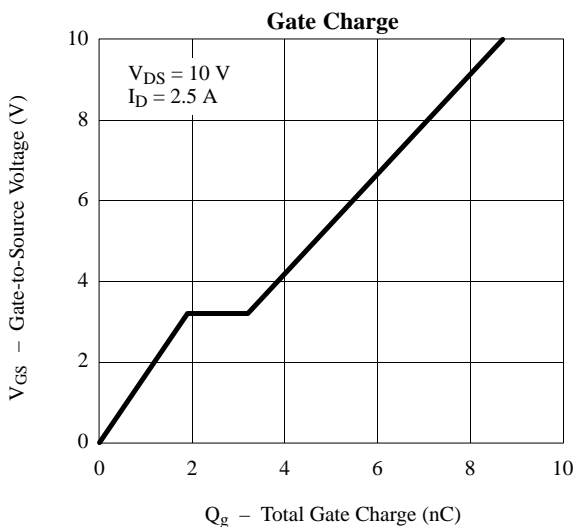
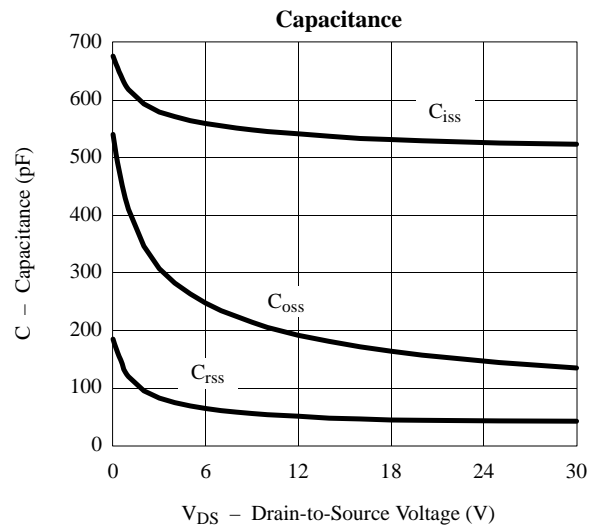
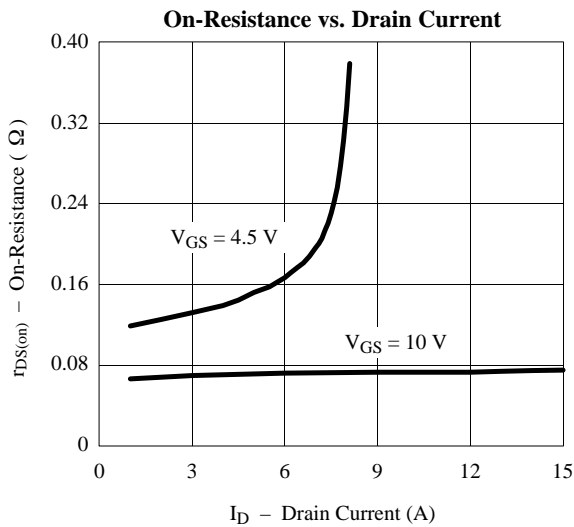
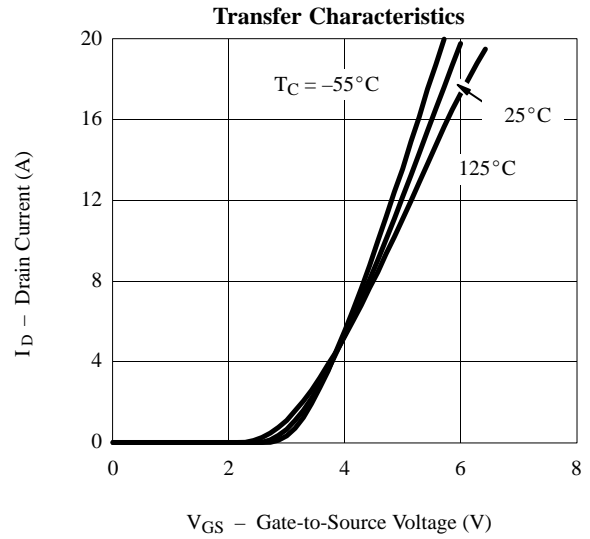
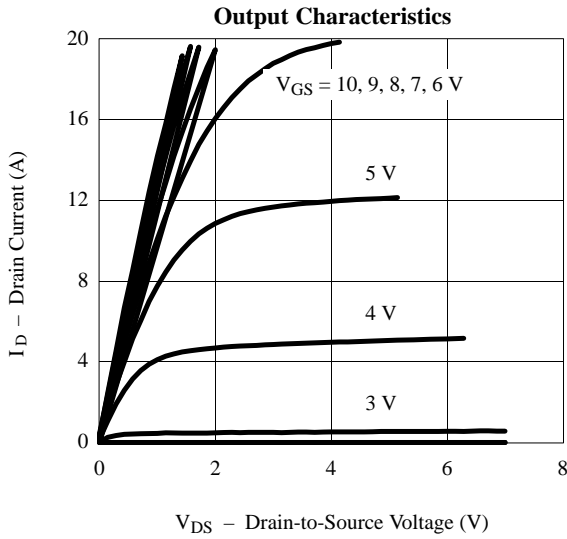

Typical Characteristics (25°C Unless Noted)

P-Channel

