

**N-Channel Enhancement-Mode MOSFET**

**Product Summary**

$V_{DS}$ (V)	$r_{DS(on)}$ ( $\Omega$ )	$I_D$ (A)
30	0.045 @ $V_{GS} = 10$ V	$\pm 4.4$
	0.070 @ $V_{GS} = 4.5$ V	$\pm 3.5$

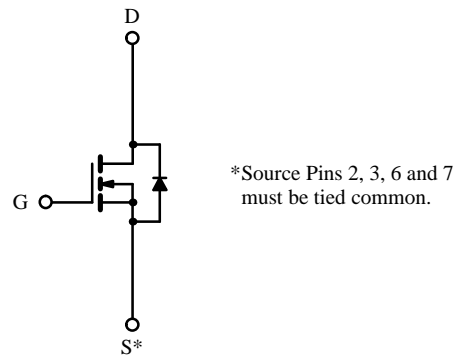
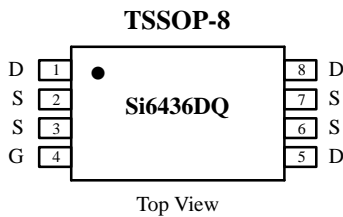

N-Channel MOSFET

**Absolute Maximum Ratings ( $T_A = 25^\circ\text{C}$  Unless Otherwise Noted)**

Parameter	Symbol	Limit	Unit
Drain-Source Voltage	$V_{DS}$	30	V
Gate-Source Voltage	$V_{GS}$	$\pm 20$	
Continuous Drain Current ( $T_J = 150^\circ\text{C}$ ) <sup>a</sup>	$I_D$	$T_A = 25^\circ\text{C}$	A
		$T_A = 70^\circ\text{C}$	
Pulsed Drain Current	$I_{DM}$	$\pm 30$	A
Continuous Source Current (Diode Conduction) <sup>a</sup>	$I_S$	1.7	
Maximum Power Dissipation <sup>a</sup>	$P_D$	$T_A = 25^\circ\text{C}$	W
		$T_A = 70^\circ\text{C}$	
Operating Junction and Storage Temperature Range	$T_J, T_{stg}$	-55 to 150	$^\circ\text{C}$

**Thermal Resistance Ratings**

Parameter	Symbol	Limit	Unit
Maximum Junction-to-Ambient <sup>a</sup>	$R_{thJA}$	83	$^\circ\text{C}/\text{W}$

Notes

a. Surface Mounted on FR4 Board,  $t \leq 10$  sec.

Subsequent updates to this data sheet may be obtained via facsimile by calling Siliconix FaxBack, 1-408-970-5600. Please request FaxBack document #1802. A SPICE Model data sheet is available for this product (FaxBack document #5127).

## Specifications ( $T_J = 25^\circ\text{C}$ Unless Otherwise Noted)

Parameter	Symbol	Test Condition	Min	Typ	Max	Unit
<b>Static</b>						
Gate Threshold Voltage	$V_{GS(th)}$	$V_{DS} = V_{GS}, I_D = 250 \mu\text{A}$	1			V
Gate-Body Leakage	$I_{GSS}$	$V_{DS} = 0 \text{ V}, V_{GS} = \pm 20 \text{ V}$			$\pm 100$	nA
Zero Gate Voltage Drain Current	$I_{DSS}$	$V_{DS} = 30 \text{ V}, V_{GS} = 0 \text{ V}$			1	$\mu\text{A}$
		$V_{DS} = 30 \text{ V}, V_{GS} = 0 \text{ V}, T_J = 55^\circ\text{C}$			20	
On-State Drain Current <sup>a</sup>	$I_{D(on)}$	$V_{DS} = 5 \text{ V}, V_{GS} = 10 \text{ V}$	20			A
Drain-Source On-State Resistance <sup>a</sup>	$r_{DS(on)}$	$V_{GS} = 10 \text{ V}, I_D = 4.4 \text{ A}$		0.034	0.045	$\Omega$
		$V_{GS} = 4.5 \text{ V}, I_D = 3.0 \text{ A}$		0.052	0.070	
Forward Transconductance <sup>a</sup>	$g_{fs}$	$V_{DS} = 15 \text{ V}, I_D = 4.4 \text{ A}$		8		S
Diode Forward Voltage <sup>a</sup>	$V_{SD}$	$I_S = 1.7 \text{ A}, V_{GS} = 0 \text{ V}$		0.75	1.2	V
<b>Dynamic<sup>b</sup></b>						
Total Gate Charge	$Q_g$	$V_{DS} = 15 \text{ V}, V_{GS} = 10 \text{ V}, I_D = 4.4 \text{ A}$		13	30	nC
Gate-Source Charge	$Q_{gs}$			1.7		
Gate-Drain Charge	$Q_{gd}$			3.7		
Turn-On Delay Time	$t_{d(on)}$	$V_{DD} = 15 \text{ V}, R_L = 15 \Omega$ $I_D \cong 1 \text{ A}, V_{GEN} = 10 \text{ V}, R_G = 6 \Omega$		12	30	ns
Rise Time	$t_r$			10	25	
Turn-Off Delay Time	$t_{d(off)}$			25	30	
Fall Time	$t_f$			10	50	
Source-Drain Reverse Recovery Time	$t_{rr}$	$I_F = 1.7 \text{ A}, di/dt = 100 \text{ A}/\mu\text{s}$		120	160	

Notes

- a. Pulse test; pulse width  $\leq 300 \mu\text{s}$ , duty cycle  $\leq 2\%$ .  
b. Guaranteed by design, not subject to production testing.

**Typical Characteristics (25°C Unless Otherwise Noted)**

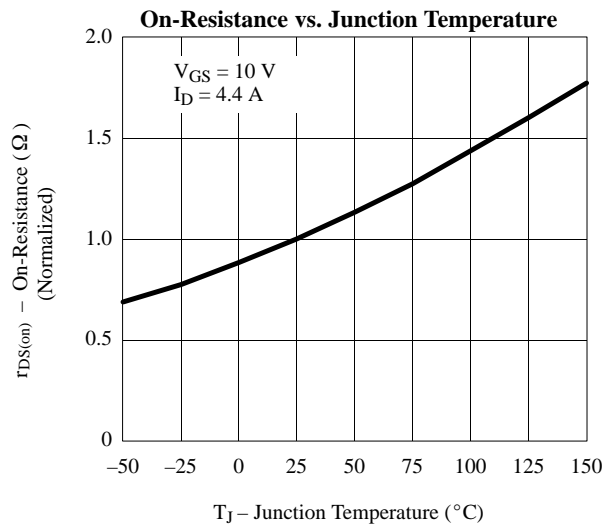
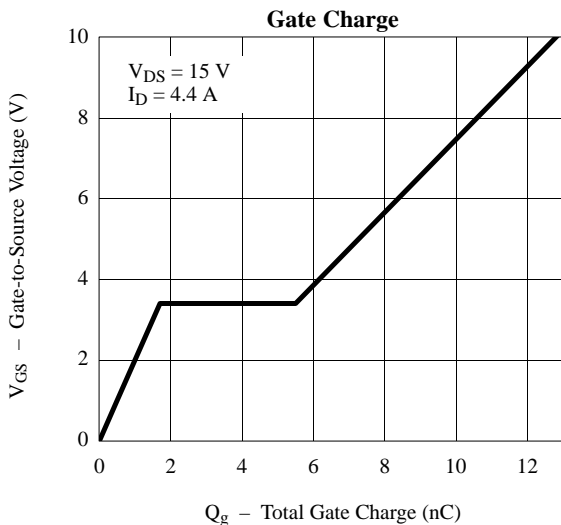
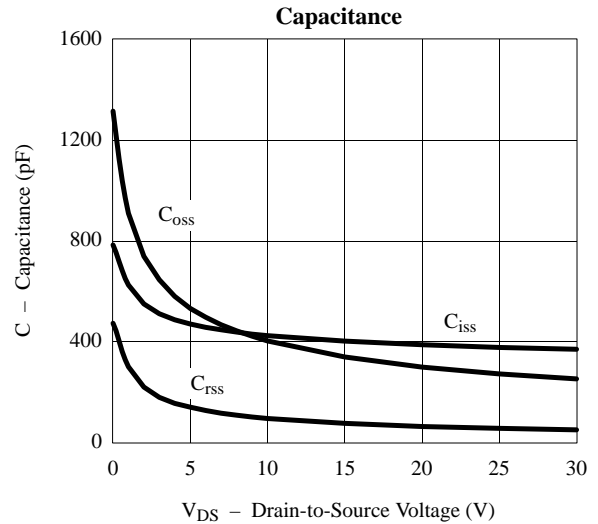
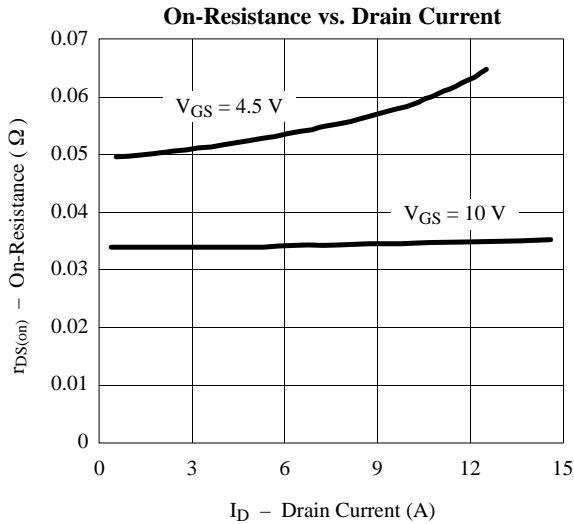
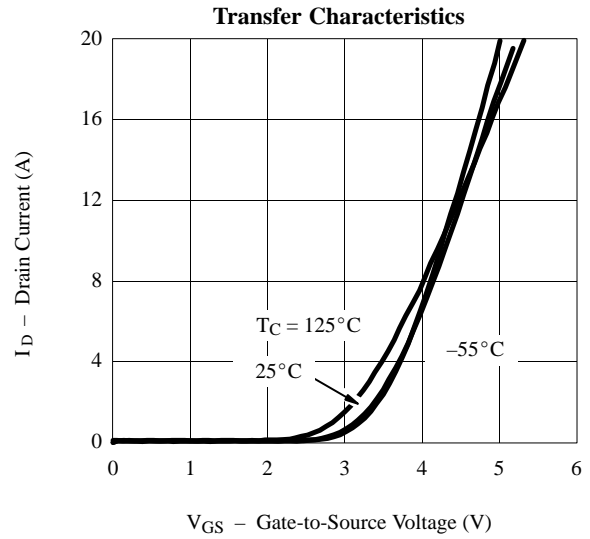
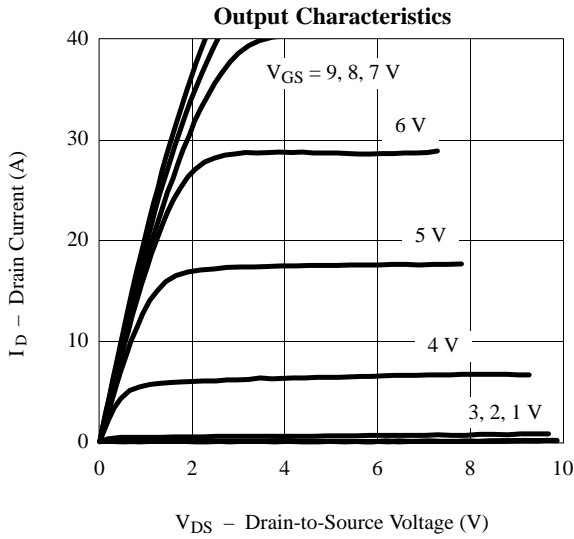

## Typical Characteristics (25°C Unless Otherwise Noted)

