

**SEMITOP® 3
IGBT Module**

SK 10 GD 123

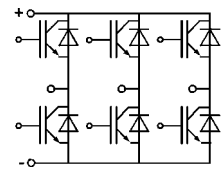
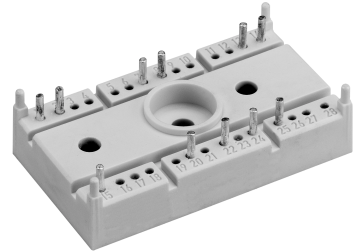

GD

Absolute Maximum Ratings			
Symbol	Conditions ¹⁾	Values	Units
V _{CEs}		1200	V
V _{GES}		± 20	V
I _C	T _h = 25/80 °C	16 / 11	A
I _{CM}	t _p < 1 ms; T _h = 25/80 °C	32 / 22	A
I _F = -I _C	T _h = 25/80 °C	18 / 12	A
I _{FM} = -I _{CM}	t _p < 1 ms; T _h = 25/80 °C	36 / 24	A
T _j		- 40 ... + 150	°C
T _{stg}		- 40 ... + 125	°C
T _{sol}	Terminals, 10 s	260	°C
V _{isol}	AC, 1 min	2500	V

Characteristics					
Symbol	Conditions ¹⁾	min.	typ.	max.	Units
V _{CEsat}	I _C = 10 A; T _j = 25 (125) °C	-	2,7(3,3)	3,2(3,9)	V
t _{d(on)}	V _{CC} = 600 V; V _{GE} = ± 15 V	-	30	-	ns
t _r	I _C = 10 A; T _j = 125 °C	-	45	-	ns
t _{d(off)}	R _{Gon} = R _{Goff} = 50 Ω	-	200	-	ns
t _f	inductive load	-	35	-	ns
E _{on} + E _{off}		-	2,3	-	mJ
C _{ies}	V _{CE} = 25 V; V _{GE} = 0V, 1 MHz	-	0,53	-	nF
R _{thjh} ³⁾	per IGBT	-	-	1,8	K/W
Inverse Diode ²⁾					
V _F = V _{EC}	I _F = 10 A; T _j = 25 (125) °C	-	2,0(1,8)	2,5(2,3)	V
V _{TO}	T _j = 125 °C	-	1,0	1,2	V
r _T	T _j = 125 °C	-	80	110	mΩ
I _{RRM}	I _F = 10 A; V _R = 600 V	-	12	-	A
Q _{rr}	di _F /dt = - 300 A/μs	-	1,8	-	μC
E _{off}	V _{GE} = 0 V; T _j = 125 °C	-	0,4	-	mJ
R _{thjh} ³⁾	per Diode	-	-	2,1	K/W
Mechanical Data					
M ₁	mounting torque	-	-	2,5	Nm
w		-	30	-	g
Case			T 12		

Features

- Compact design
- One screw mounting
- Heat transfer and isolation through direct copper bonded aluminium oxide ceramic (DCB)
- N channel, homogeneous silicon structure (NPT Non-Punch-through IGBT)
- High short circuit capability
- Fast and soft inverse CAL-diodes
- UL recognized, file no. E 63 532

Typical Applications

- Switching (not for linear use)
- Inverter
- Switched mode power supplies
- UPS

¹⁾ T_h = 25 °C, unless otherwise specified
²⁾ CAL = Controlled Axial Lifetime Technology (soft and fast recovery)
³⁾ Thermal resistance junction to heatsink

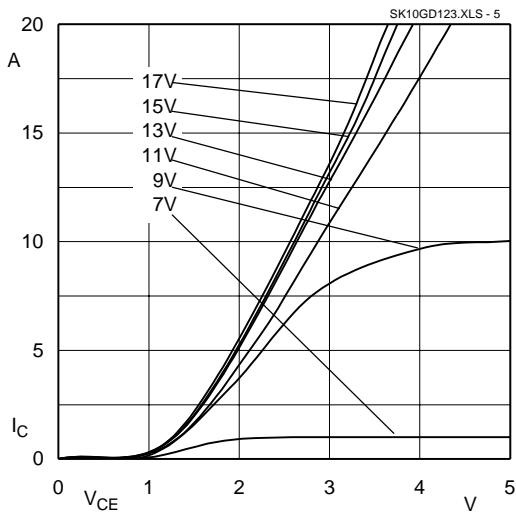

Fig. 5 Typ. output characteristic, $t_p = 80 \mu s$; $25^\circ C$

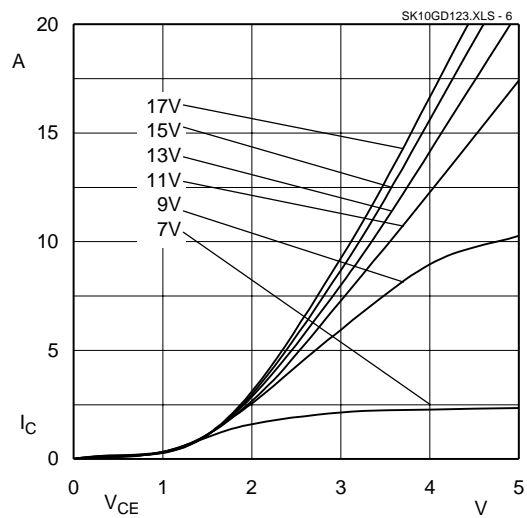

Fig. 6 Typ. output characteristic, $t_p = 80 \mu s$; $125^\circ C$

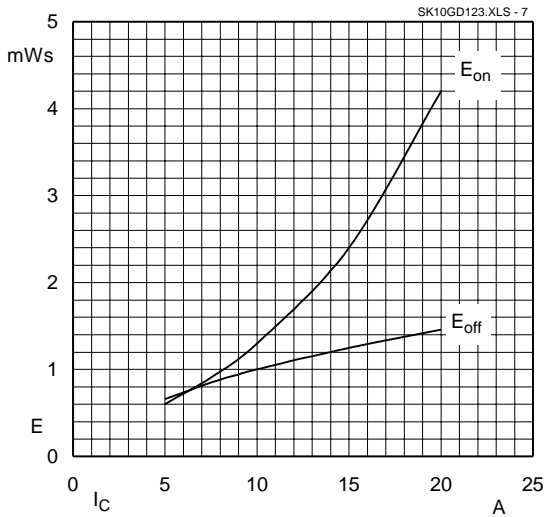

Fig. 7 Turn-on /-off energy = $f(I_c)$

$T_j = 125^\circ C$
 $V_{CC} = 600 V$
 $V_{GE} = \pm 15 V$
 $R_G = 50 \Omega$

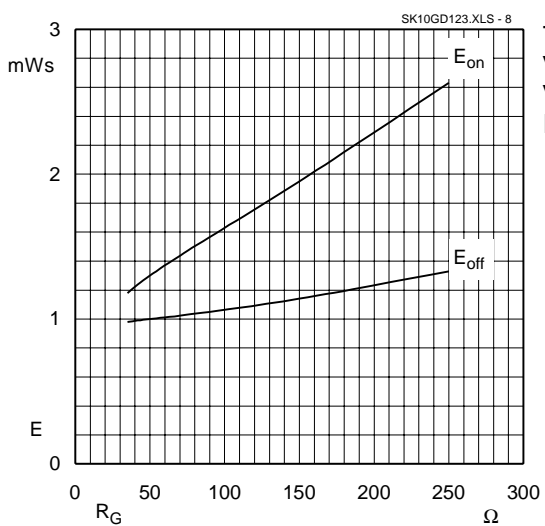

Fig. 8 Turn-on /-off energy = $f(R_G)$

$T_j = 125^\circ C$
 $V_{CC} = 600 V$
 $V_{GE} = \pm 15 V$
 $I_c = 10 A$

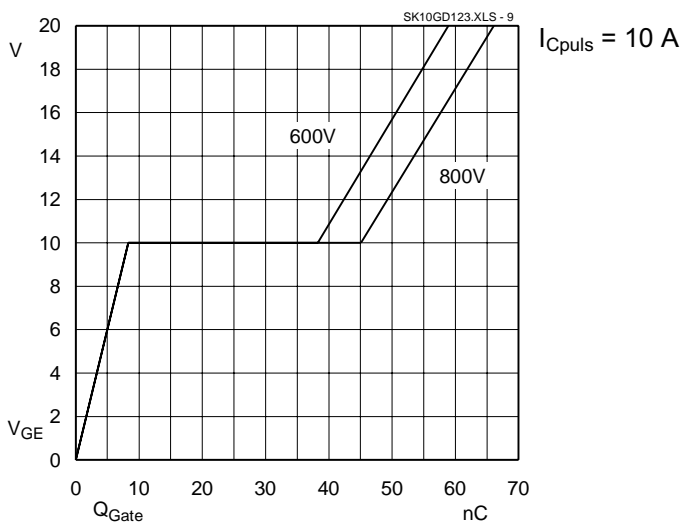

Fig. 9 Typ. gate charge characteristic

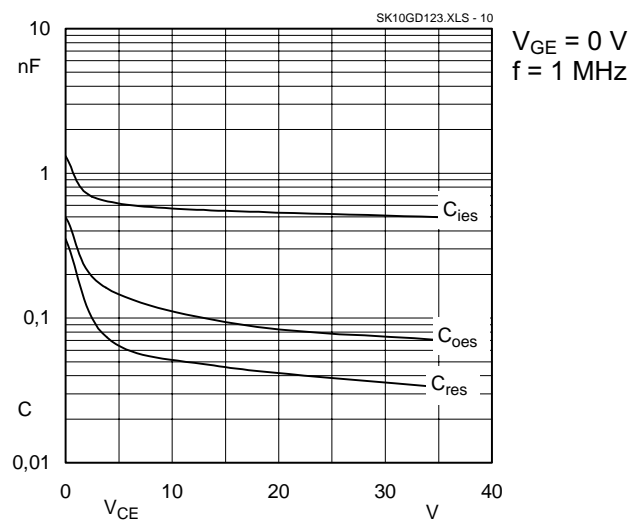

Fig. 10 Typ. capacitances vs. V_{CE}

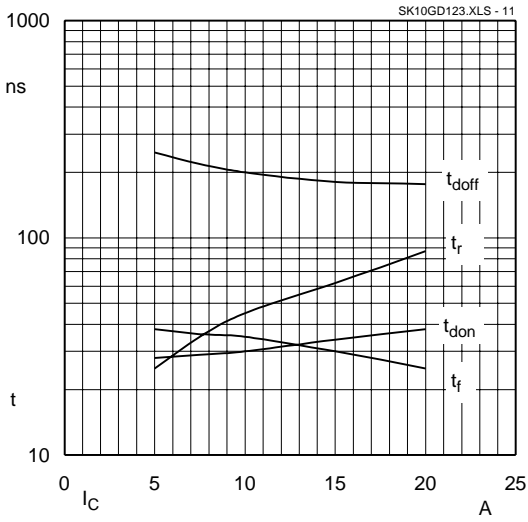

Fig. 11 Typ. switching times vs. I_C

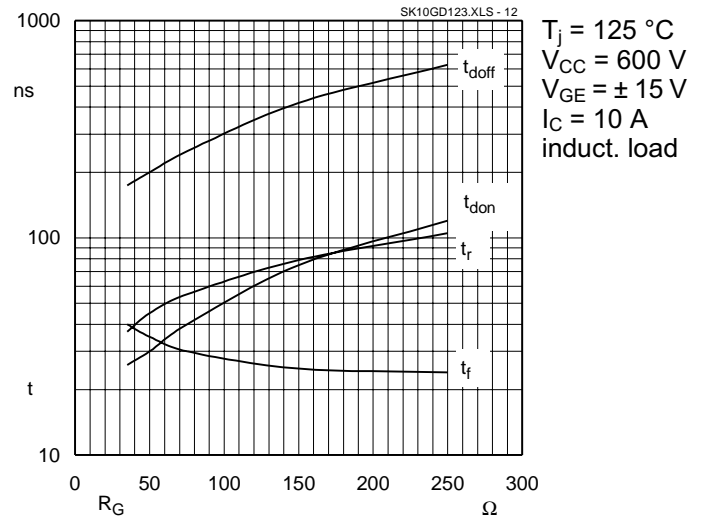

Fig. 12 Typ. switching times vs. gate resistor R_G

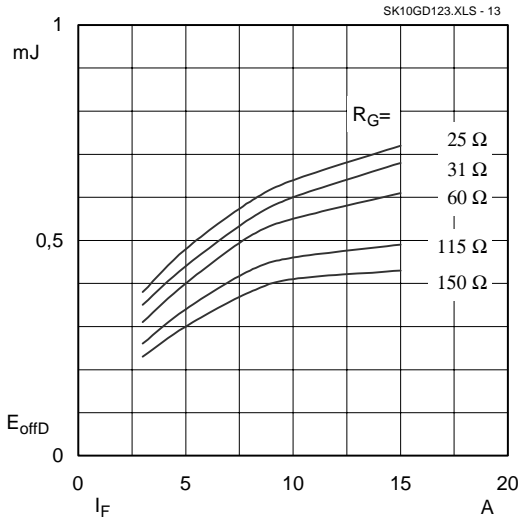
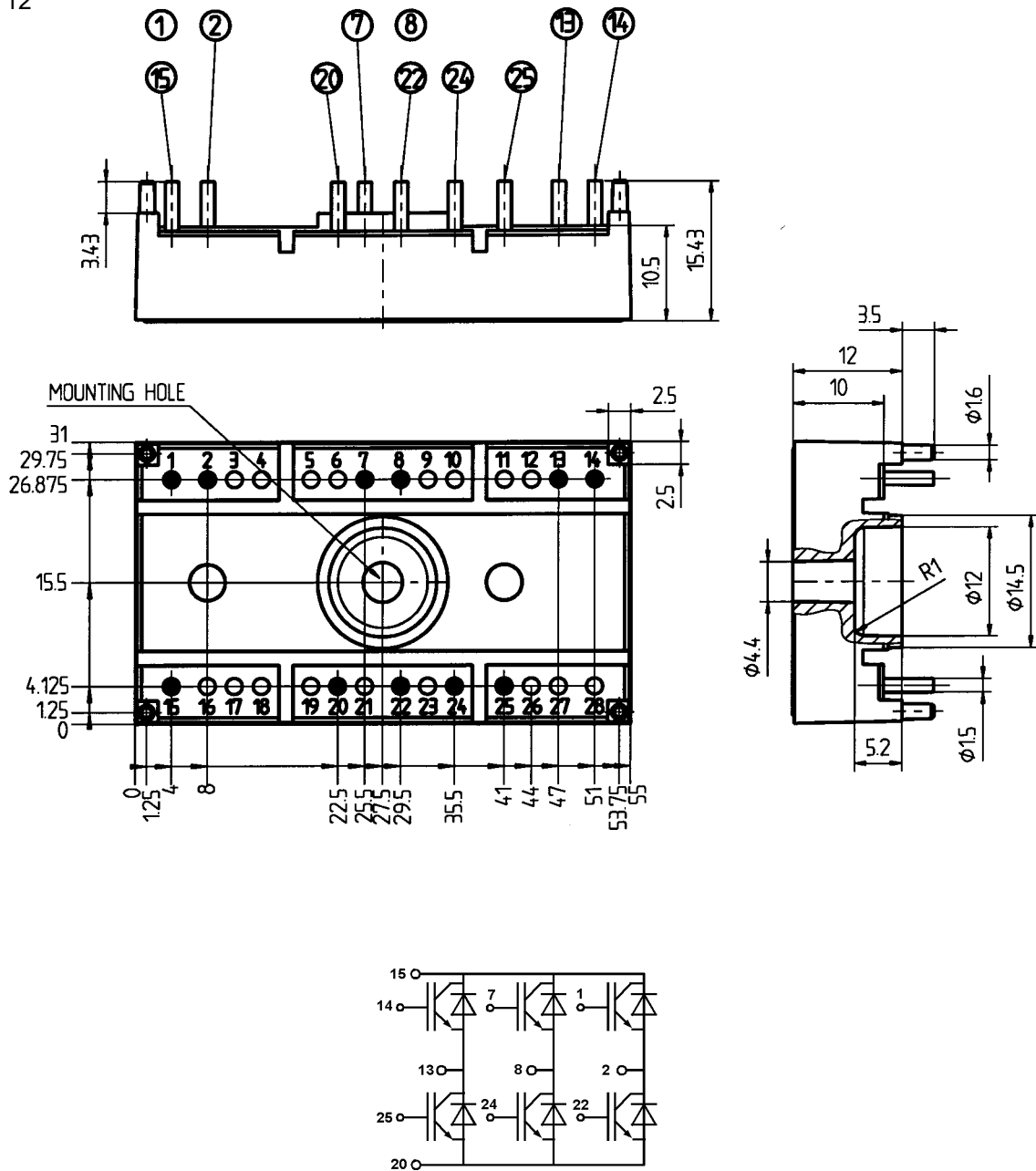

Fig. 13 Diode turn-off energy dissipation per pulse

I:\Marketing\FRAMEDAT\datab\B17-Semitor\sk10gd123.fm

SEMITOP® 3
SK 10 GD 123

Case T 12



Dimensions in mm

This technical information specifies semiconductor devices but promises no characteristics. No warranty or guarantee expressed or implied is made regarding delivery, performance or suitability.