

Absolute Maximum Ratings		Values	Units
Symbol	Conditions ¹⁾		
IGBT			
V_{CES}		1200	V
V_{GES}		± 20	V
I_C	$T_h = 25/80\text{ }^\circ\text{C}$	33 / 22	A
I_{CM}	$t_p < 1\text{ ms}; T_h = 25/80\text{ }^\circ\text{C}$	66 / 44	A
$I_F = -I_C$	$T_h = 25/80\text{ }^\circ\text{C}$	18 / 12	A
$I_{FM} = -I_{CM}$	$t_p < 1\text{ ms}; T_h = 25/80\text{ }^\circ\text{C}$	36 / 24	A
Bridge Rectifier			
V_{RRM}		1200	V
I_D		16	A
I_{FSM}		100	A
i^2t		500	A ² s
T_j		- 40 ... + 150	$^\circ\text{C}$
T_{stg}		- 40 ... + 125	$^\circ\text{C}$
T_{sol}	Terminals, 10 s	260	$^\circ\text{C}$
V_{isol}	AC, 1 min	2500	V

Characteristics					Units
Symbol	Conditions ¹⁾	min.	typ.	max.	
V_{CEsat}	$I_C = 25\text{ A}; T_j = 25\text{ (125)}\text{ }^\circ\text{C}$	-	2,5(3,1)	3,0(3,7)	V
$t_{d(on)}$	$V_{CC} = 600\text{ V}; V_{GE} = \pm 15\text{ V}$ $I_C = 25\text{ A}; T_j = 125\text{ }^\circ\text{C}$ $R_{Gon} = R_{Goff} = 25\text{ }\Omega$ inductive load	-	65	-	ns
t_r		-	100	-	ns
$t_{d(off)}$		-	430	-	ns
t_f		-	35	-	ns
$E_{on} + E_{off}$		-	7	-	mJ
C_{ies}	$V_{CE} = 25\text{ V}; V_{GE} = 0\text{ V}; 1\text{ MHz}$	-	1,65	-	nF
R_{thjh} ³⁾	per IGBT	-	-	1,0	K/W
Inverse Diode ²⁾ & Rectifier diode					
$V_F = V_{EC}$	$I_F = 10\text{ A}; T_j = 25\text{ (125)}\text{ }^\circ\text{C}$	-	2,0(1,8)	2,5(2,3)	V
V_{TO}	$T_j = 125\text{ }^\circ\text{C}$	-	1,0	1,2	V
r_T	$T_j = 125\text{ }^\circ\text{C}$	-	80	110	m Ω
I_{RRM}	$I_F = 10\text{ A}; V_R = 600\text{ V}$ $di_F/dt = -300\text{ A}/\mu\text{s}$ $V_{GE} = 0\text{ V}; T_j = 125\text{ }^\circ\text{C}$	-	12	-	A
Q_{rr}		-	1,8	-	μC
E_{off}		-	0,4	-	mJ
R_{thjh} ³⁾	per Diode	-	-	2,1	K/W
Mechanical Data					
M_1	mounting torque	-	-	2,5	Nm
w		-	30	-	g
Case			T 23		

SEMITOP[®] 3 IGBT Module

SK 13 BGB 123 F

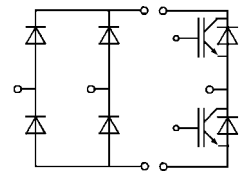
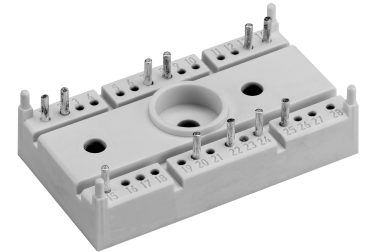

BGB

Features

- Compact design
- One screw mounting
- Heat transfer and isolation through direct copper bonded aluminium oxide ceramic (DCB)
- N channel, homogeneous silicon structure (NPT Non-Punch-through IGBT)
- High short circuit capability
- Fast and soft inverse CAL-diodes
- UL recognized, file no. E 63 532

Typical Applications

- Switching (not for linear use)
- Inverter
- Switched mode power supplies
- UPS

¹⁾ $T_h = 25\text{ }^\circ\text{C}$, unless otherwise specified

²⁾ CAL = Controlled Axial Lifetime Technology (soft and fast recovery)

³⁾ Thermal resistance junction to heatsink

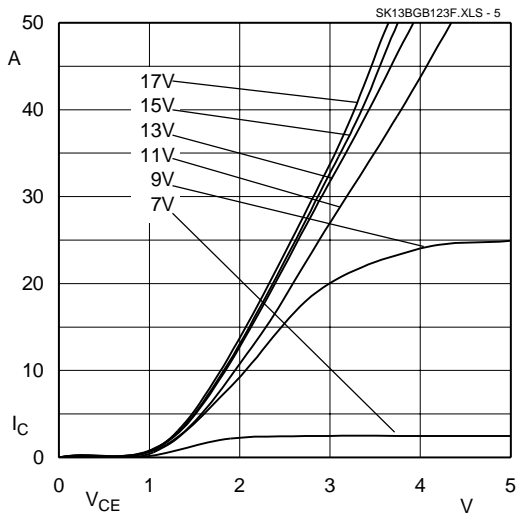

Fig. 5 Typ. output characteristic, $t_p = 80 \mu s$; $25 \text{ }^\circ\text{C}$

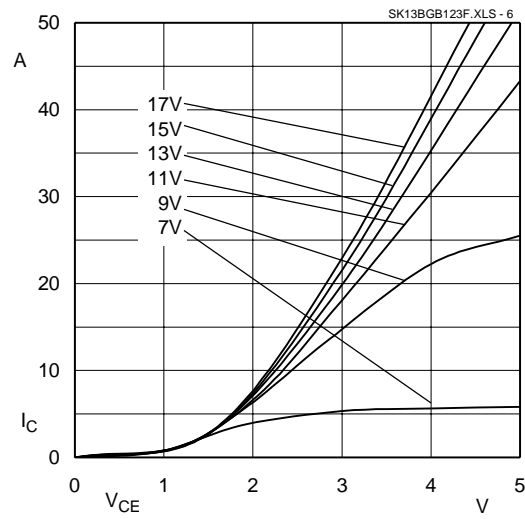

Fig. 6 Typ. output characteristic, $t_p = 80 \mu s$; $125 \text{ }^\circ\text{C}$

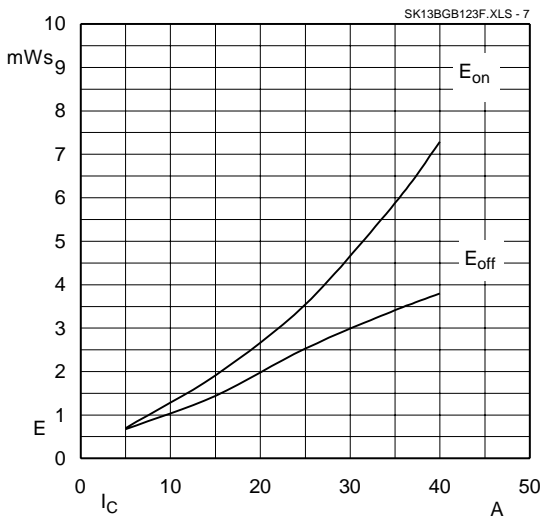

Fig. 7 Turn-on /-off energy = $f(I_C)$

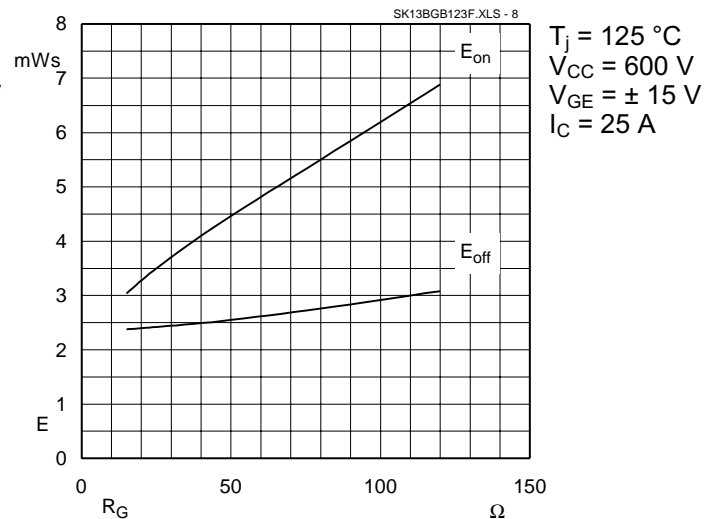

Fig. 8 Turn-on /-off energy = $f(R_G)$

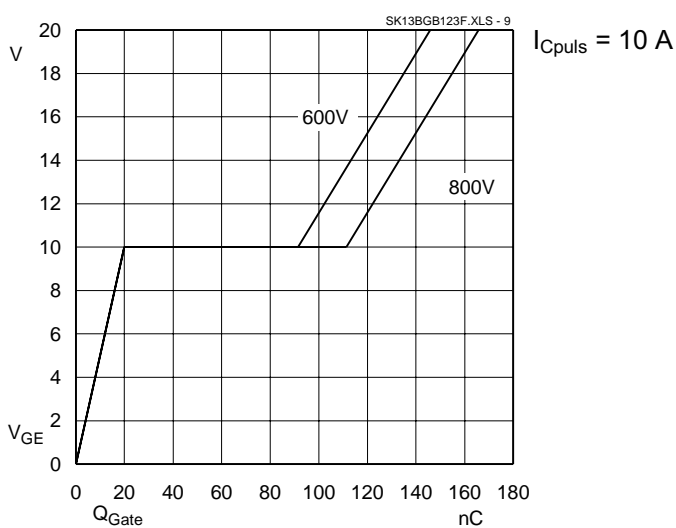

Fig. 9 Typ. gate charge characteristic

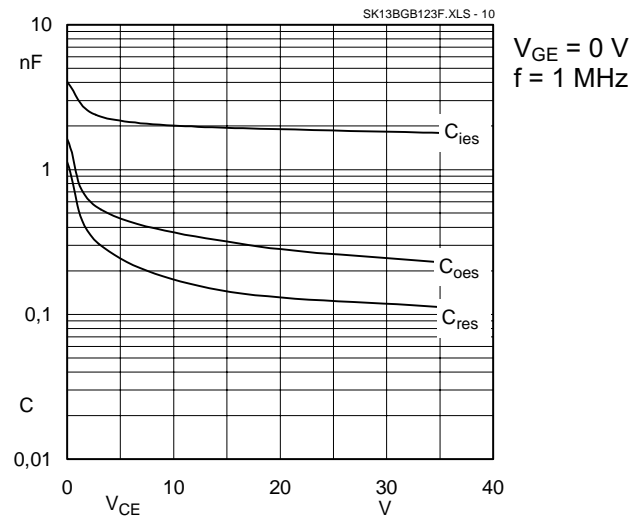

Fig. 10 Typ. capacitances vs. V_{CE}

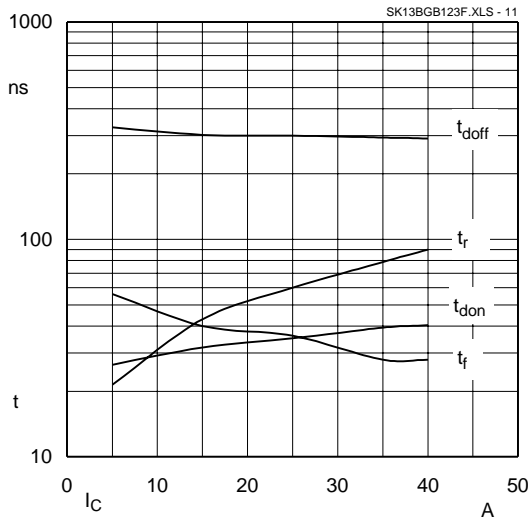

Fig. 11 Typ. switching times vs. I_C

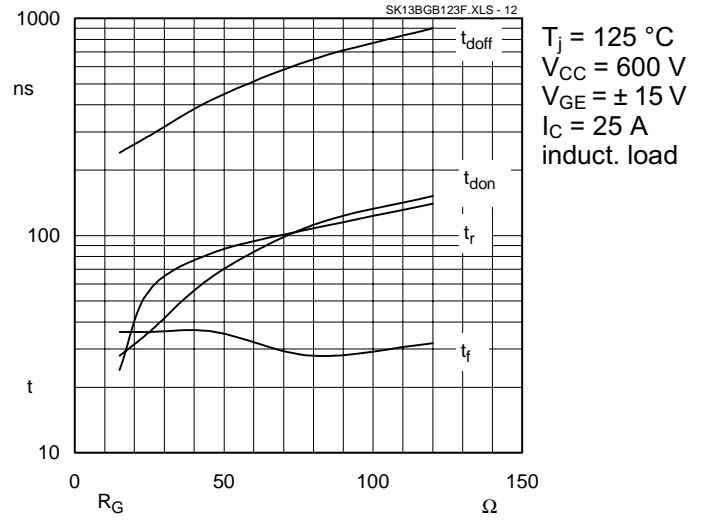
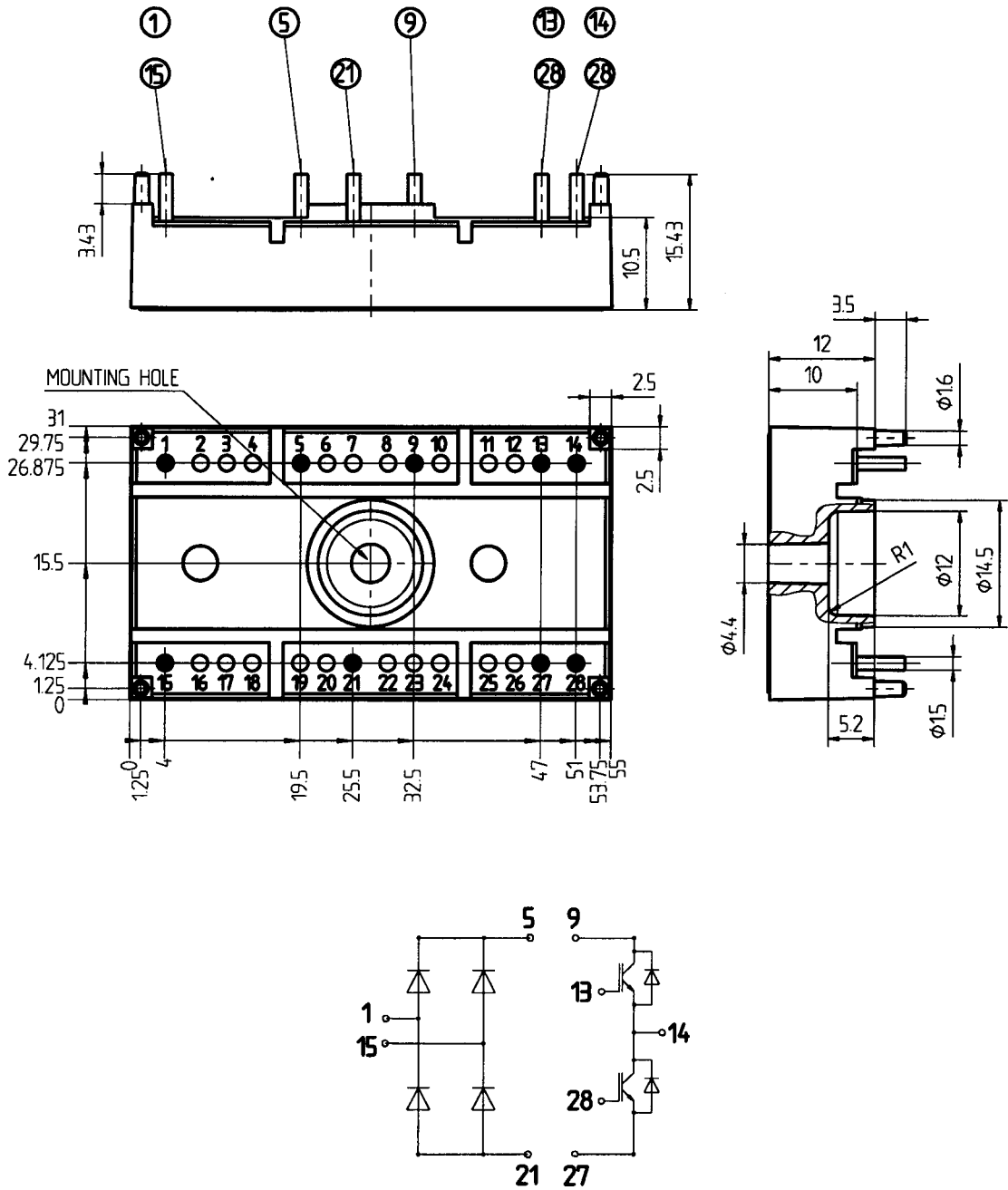

Fig. 12 Typ. switching times vs. gate resistor R_G

SEMITOP® 3

SK 13 BGB 123 F

Case T 23



Dimensions in mm

This technical information specifies semiconductor devices but promises no characteristics. No warranty or guarantee expressed or implied is made regarding delivery, performance or suitability.