

### SEMITOP® 3 IGBT Module

### SK 25 GD 063

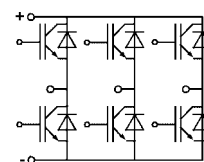
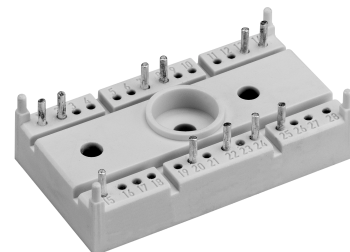

GD

Absolute Maximum Ratings		Values	Units
Symbol	Conditions <sup>1)</sup>		
$V_{CES}$		600	V
$V_{GES}$		$\pm 20$	V
$I_C$	$T_h = 25/80\text{ °C}$	30 / 21	A
$I_{CM}$	$t_p < 1\text{ ms}; T_h = 25/80\text{ °C}$	60 / 42	A
$I_F = -I_C$	$T_h = 25/80\text{ °C}$	36 / 24	A
$I_{FM} = -I_{CM}$	$t_p < 1\text{ ms}; T_h = 25/80\text{ °C}$	72 / 48	A
$T_j$		- 40 ... + 150	°C
$T_{stg}$		- 40 ... + 125	°C
$T_{sol}$	Terminals, 10 s	260	°C
$V_{isol}$	AC, 1 min	2500	V

Characteristics		min.	typ.	max.	Units
Symbol	Conditions <sup>1)</sup>				
$V_{CEsat}$	$I_C = 20\text{ A}; T_j = 25\text{ (125) °C}$	-	1,8(1,9)	2,2(2,4)	V
$t_{d(on)}$	$V_{CC} = 300\text{ V}; V_{GE} = \pm 15\text{ V}$ $I_C = 25\text{ A}, T_j = 125\text{ °C}$ $R_{Gon} = R_{Goff} = 33\ \Omega$ inductive load	-	40	-	ns
$t_r$		-	50	-	ns
$t_{d(off)}$		-	200	-	ns
$t_f$		-	25	-	ns
$E_{on} + E_{off}$		-	2,2	-	mJ
$C_{ies}$	$V_{CE} = 25\text{ V}; V_{GE} = 0\text{ V}, 1\text{ MHz}$	-	1,6	-	nF
$R_{thjh}$ <sup>3)</sup>	per IGBT	-	-	1,4	K/W
Inverse Diode <sup>2)</sup>					
$V_F = V_{EC}$	$I_F = 25\text{ A}; T_j = 25\text{ (125) °C}$	-	1,45(1,4)	1,7(1,75)	V
$V_{TO}$	$T_j = 125\text{ °C}$	-	0,85	0,9	V
$r_T$	$T_j = 125\text{ °C}$	-	22	32	m $\Omega$
$I_{RRM}$	$I_F = 25\text{ A}; V_R = 300\text{ V}$ $di_F/dt = -500\text{ A}/\mu\text{s}$ $V_{GE} = 0\text{ V}; T_j = 125\text{ °C}$	-	16	-	A
$Q_{rr}$		-	2	-	$\mu\text{C}$
$E_{off}$		-	0,25	-	mJ
$R_{thjh}$ <sup>3)</sup>		per Diode	-	-	1,7
Mechanical Data					
M1	mounting torque	-	-	2,5	Nm
w		-	30	-	g
Case			T 12		

#### Features

- Compact design
- One screw mounting
- Heat transfer and isolation through direct copper bonded aluminium oxide ceramic (DCB)
- N channel, homogeneous silicon structure (NPT Non punch-through IGBT)
- High short circuit capability
- Low tail current with low temperature dependence
- UL recognized, file no. E 63 532

#### Typical Applications

- Switching (not for linear use)
- Inverter
- Switched mode power supplies
- UPS

<sup>1)</sup>  $T_h = 25\text{ °C}$ , unless otherwise specified

<sup>2)</sup> CAL = Controlled Axial Lifetime Technology ( soft and fast recovery)

<sup>3)</sup> Thermal resistance junction to heatsink

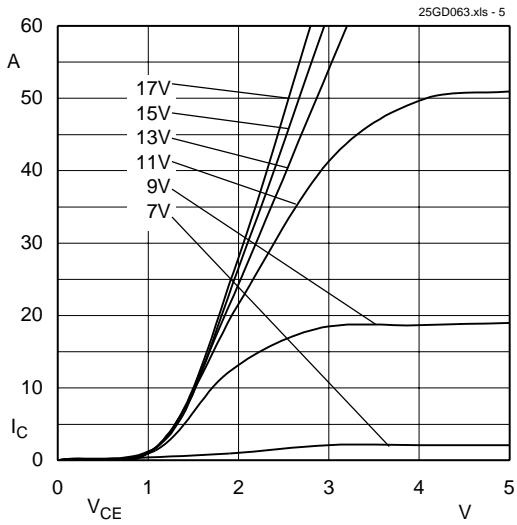

Fig. 5 Typ. output characteristic,  $t_p = 80 \mu s$ ;  $25 \text{ }^\circ\text{C}$

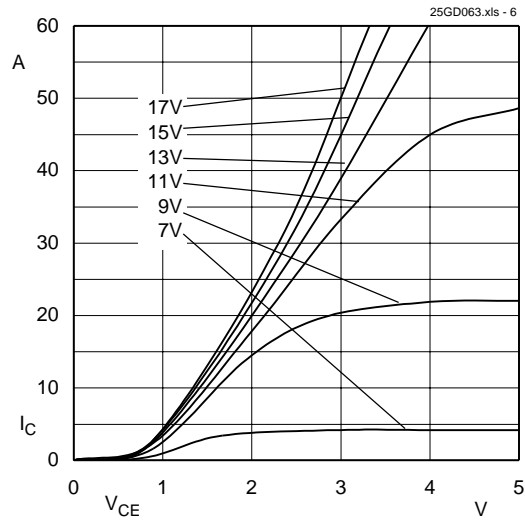

Fig. 6 Typ. output characteristic,  $t_p = 80 \mu s$ ;  $125 \text{ }^\circ\text{C}$

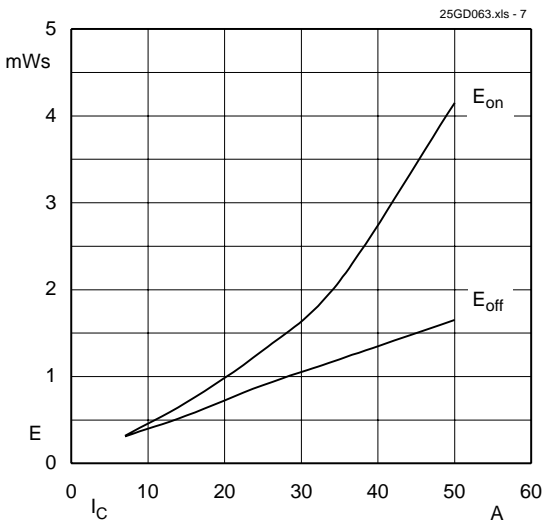

Fig. 7 Turn-on /-off energy =  $f(I_C)$

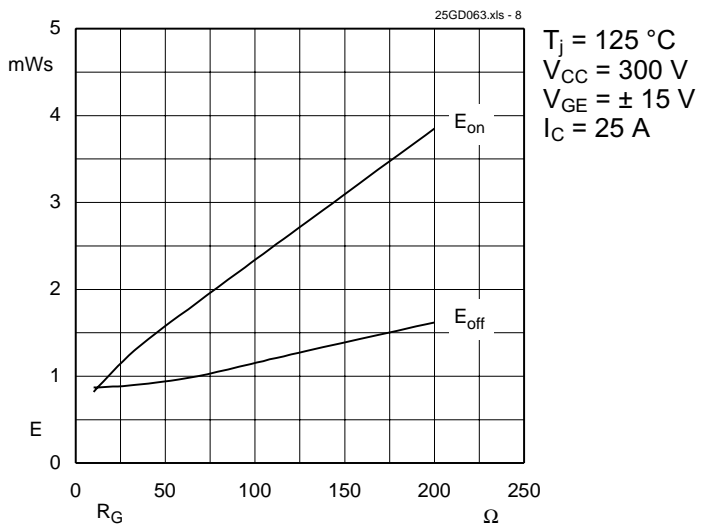

Fig. 8 Turn-on /-off energy =  $f(R_G)$

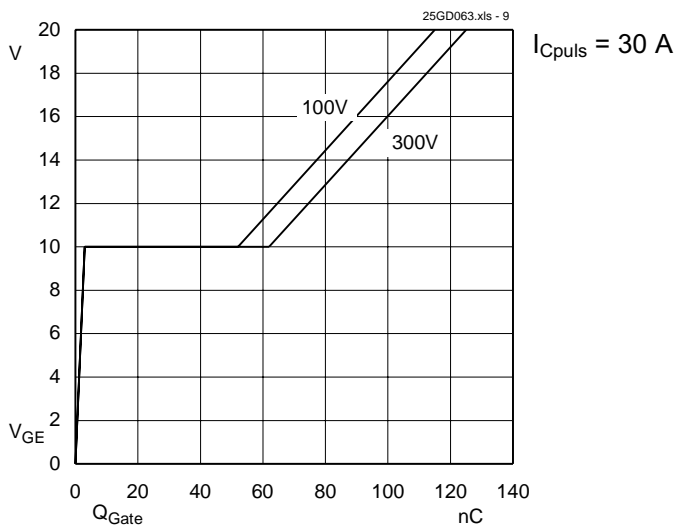

Fig. 9 Typ. gate charge characteristic

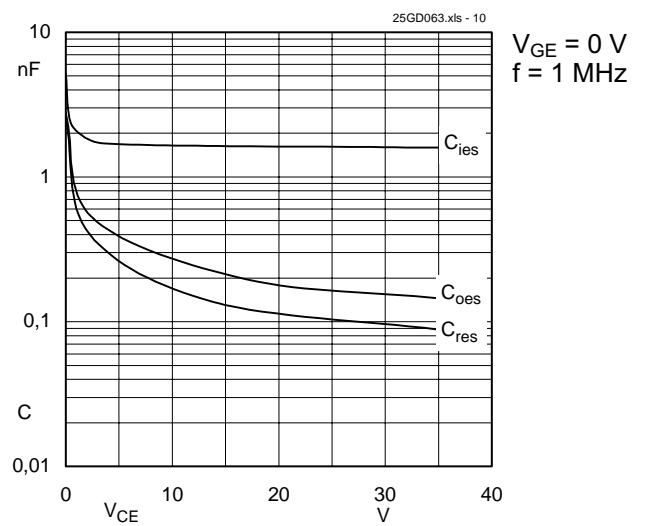

Fig. 10 Typ. capacitances vs.  $V_{CE}$

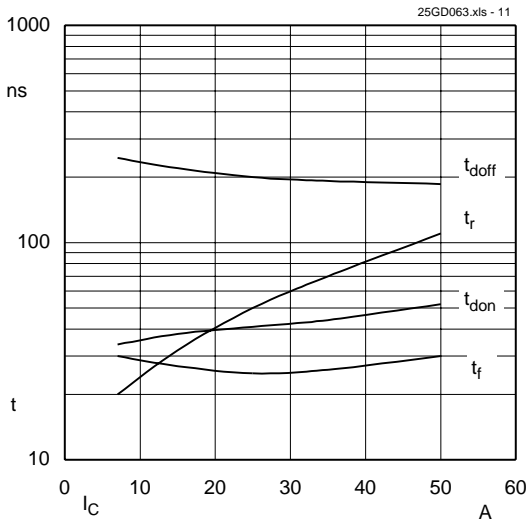

Fig. 11 Typ. switching times vs.  $I_C$

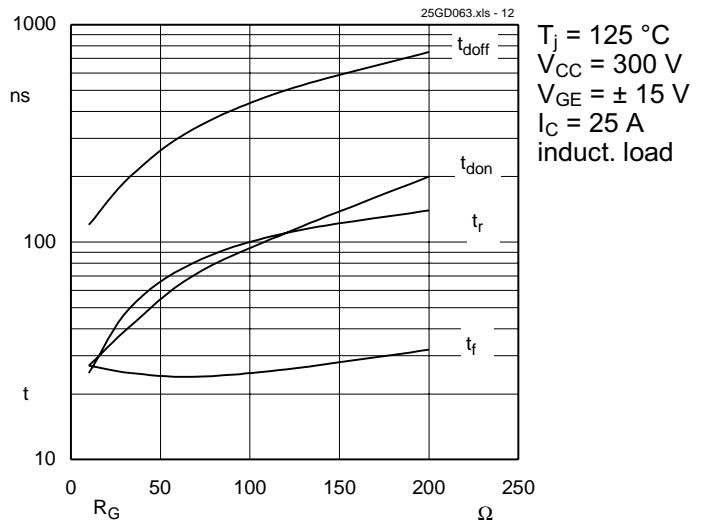

Fig. 12 Typ. switching times vs. gate resistor  $R_G$

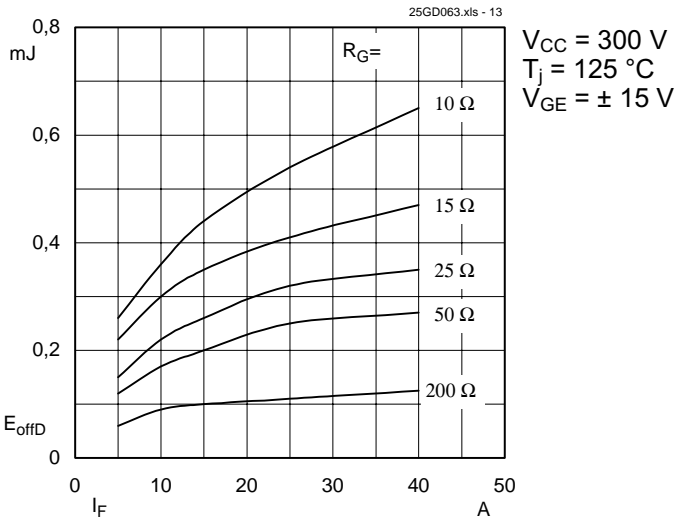
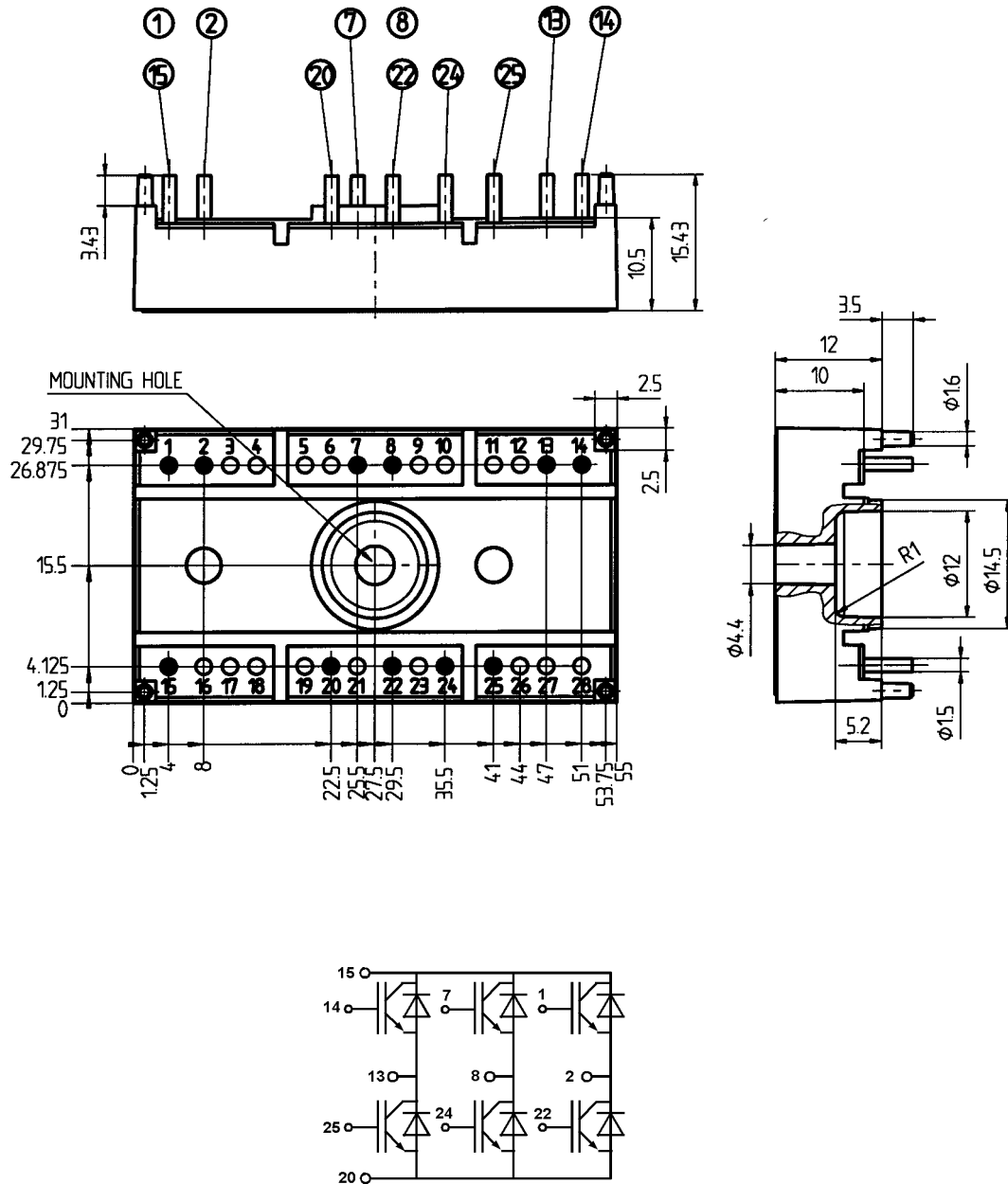

Fig. 13 Diode turn-off energy dissipation per pulse

SEMITOP® 3  
SK 25 GD 063

Case T 12



Dimensions in mm

This technical information specifies semiconductor devices but promises no characteristics. No warranty or guarantee expressed or implied is made regarding delivery, performance or suitability.