

Absolute Maximum Ratings			
Symbol	Conditions ¹⁾	Values	Units
V _{CEs}		1200	V
V _{GES}		± 20	V
I _C	T _h = 25/80 °C	58 / 40	A
I _{CM}	t _p < 1 ms; T _h = 25/80 °C	116 / 80	A
I _F = -I _C	T _h = 25/80 °C	57 / 38	A
I _{FM} = -I _{CM}	t _p < 1 ms; T _h = 25/80 °C	104 / 76	A
T _j		- 40 ... + 150	°C
T _{stg}		- 40 ... + 125	°C
T _{sol}	Terminals, 10 s	260	°C
V _{isol}	AC, 1 min	2500	V

SEMITOP® 2 IGBT Module

SK 60 GAL 123 SK 60 GAR 123

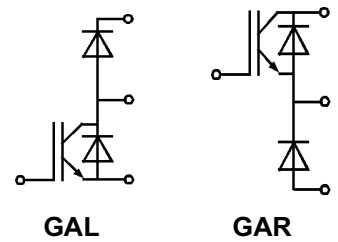
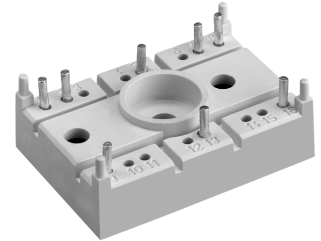

Characteristics					
Symbol	Conditions ¹⁾	min.	typ.	max.	Units
V _{CEsat}	I _C = 50 A; T _j = 25 (125) °C	-	2,5(3,1)	3,0(3,7)	V
t _{d(on)}	V _{CC} = 600 V; V _{GE} = ± 15 V	-	70	-	ns
t _r	I _C = 50 A; T _j = 125 °C	-	90	-	ns
t _{d(off)}	R _{Gon} = R _{Goff} = 22 Ω	-	460	-	ns
t _f	inductive load	-	30	-	ns
E _{on} + E _{off}		-	16	-	mJ
C _{ies}	V _{CE} = 25 V; V _{GE} = 0 V, 1 MHz	-	3,3	-	nF
R _{thjh} ³⁾	per IGBT	-	-	0,6	K/W
FWD Diode ^{2) 4)}					
V _F = V _{EC}	I _F = 50 A; T _j = 25 (125) °C	-	2,0(1,8)	2,5	V
V _{TO}	T _j = 125 °C	-	-	1,2	V
r _T	T _j = 125 °C	-	18	22	mΩ
I _{RRM}	I _F = 50 A; V _R = 600 V	-	23(35)	-	A
Q _{rr}	di _F /dt = - 800 A/μs	-	2,3(8)	-	μC
E _{off}	V _{GE} = 0 V; T _j = 125 °C	-	2,3	-	mJ
R _{thjh} ³⁾	per Diode	-	-	0,9	K/W
Mechanical Data					
M ₁	mounting torque	-	-	2,0	Nm
w		-	19	-	g
Case			T 18		

Features

- Compact design
- One screw mounting
- Heat transfer and isolation through direct copper bonded aluminium oxide ceramic (DCB)
- N channel, homogeneous silicon structure (NPT Non punch-through IGBT)
- High short circuit capability
- Low tail current with low temperature dependence
- UL recognized, file no. E 63 532

Typical Applications

- Switching (not for linear use)
- Inverter
- Switched mode power supplies
- UPS

- ¹⁾ T_h = 25 °C, unless otherwise specified
- ²⁾ CAL = Controlled Axial Lifetime Technology (soft and fast recovery)
- ³⁾ Thermal resistance junction to heatsink
- ⁴⁾ Antiparallel diode of IGBT is only a small security diode

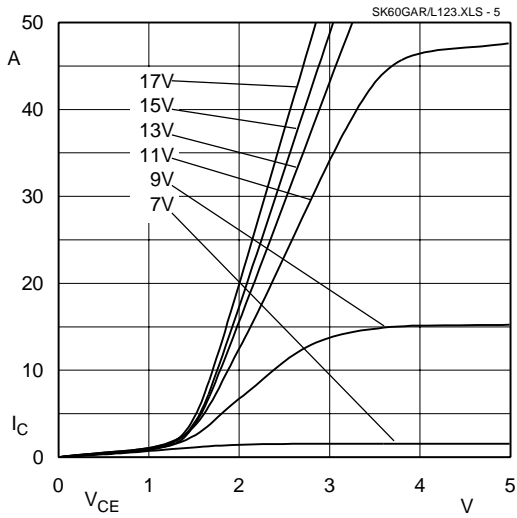

Fig. 5 Typ. output characteristic, $t_p = 80 \mu s$; $25^\circ C$

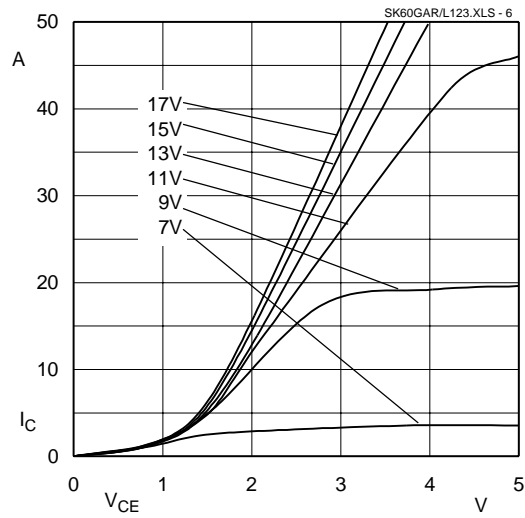

Fig. 6 Typ. output characteristic, $t_p = 80 \mu s$; $125^\circ C$

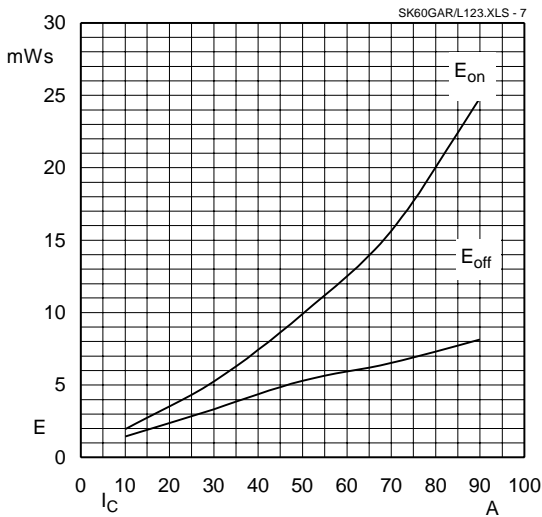

Fig. 7 Turn-on /-off energy = $f(I_c)$

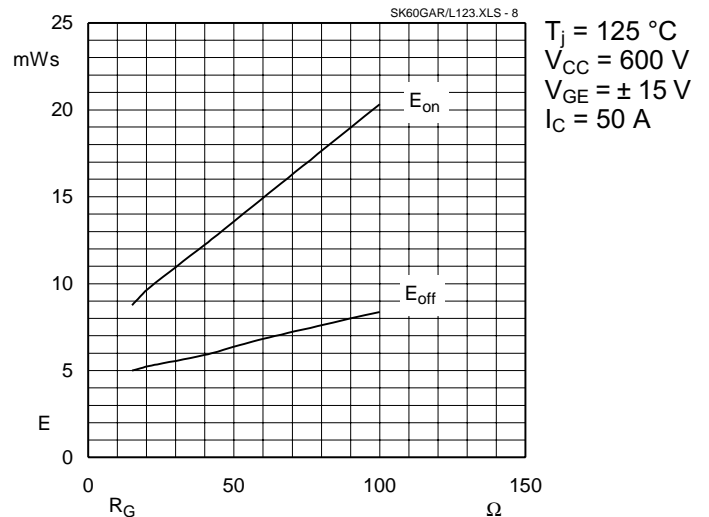

Fig. 8 Turn-on /-off energy = $f(R_g)$

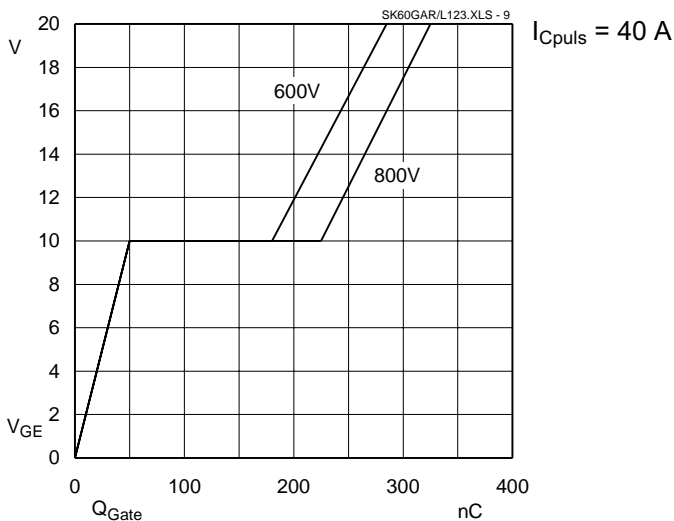

Fig. 9 Typ. gate charge characteristic

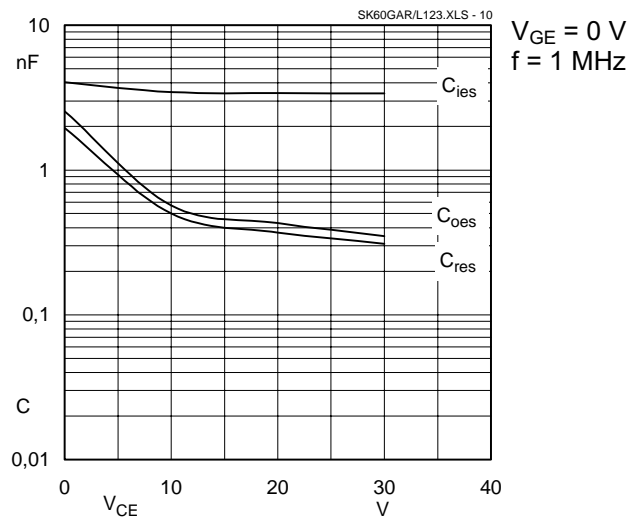

Fig. 10 Typ. capacitances vs. V_{CE}

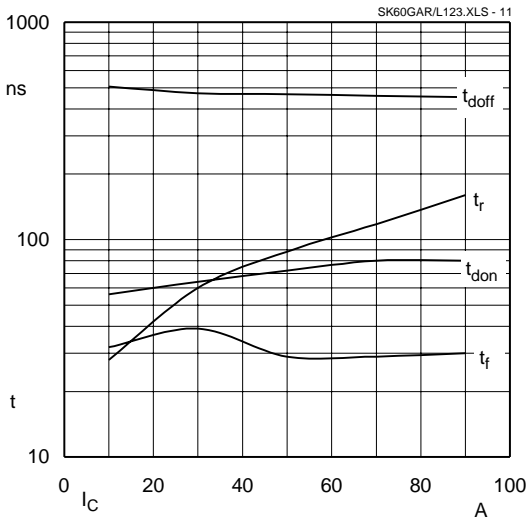

Fig. 11 Typ. switching times vs. I_C

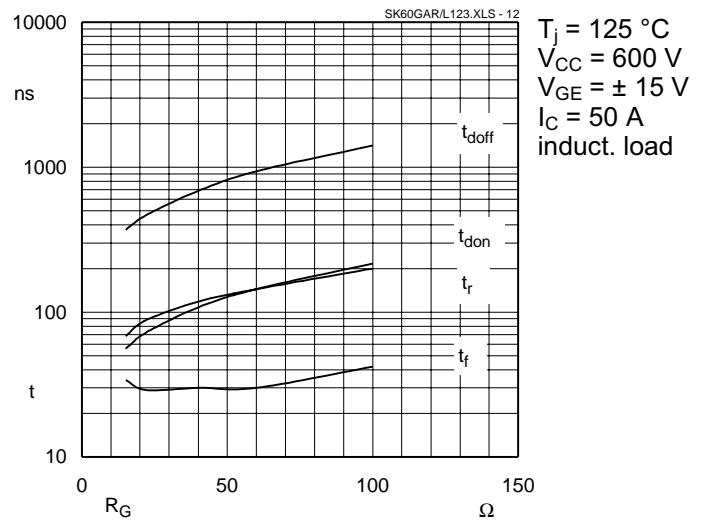

Fig. 12 Typ. switching times vs. gate resistor R_G

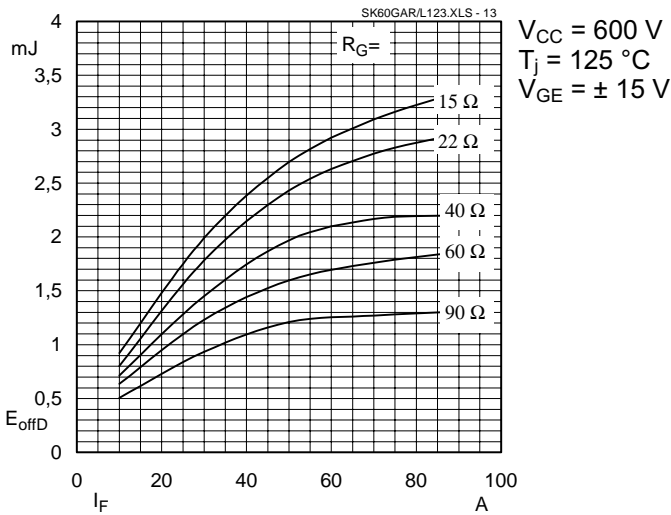
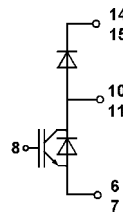
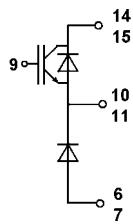
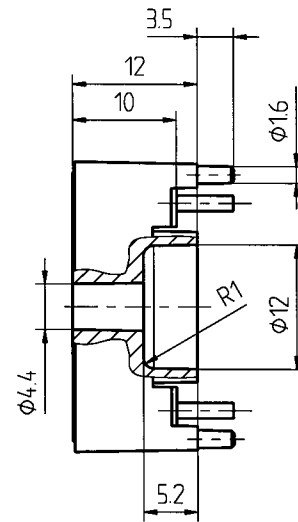
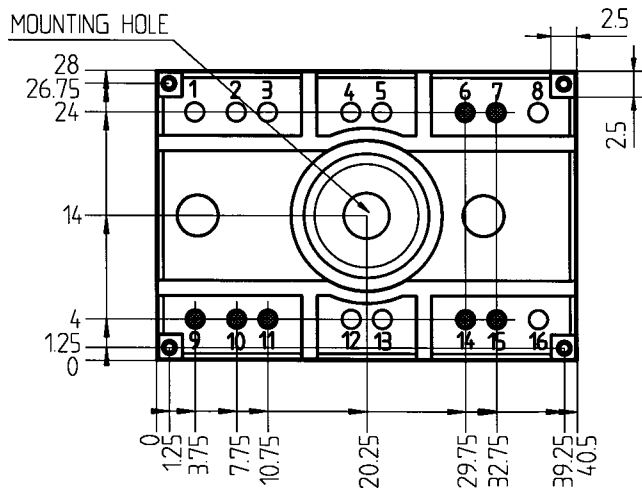
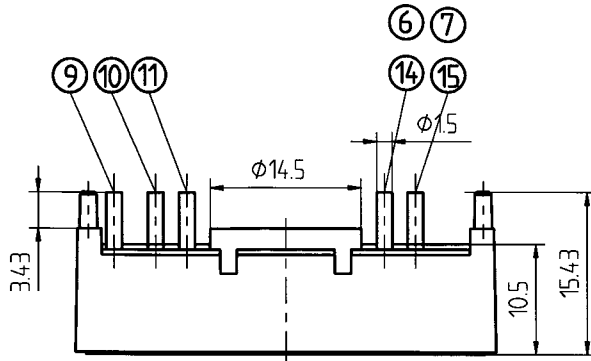

Fig. 13 Diode turn-off energy dissipation per pulse

SEMITOP® 2
SK 60 GAL 123
SK 60 GAR 123

Case T 18



GAR

GAL

Dimensions in mm

This technical information specifies semiconductor devices but promises no characteristics. No warranty or guarantee expressed or implied is made regarding delivery, performance or suitability.