

Absolute Maximum Ratings		Values			Units
Symbol	Conditions ¹⁾				
V _{CES}		1200			V
V _{CGR}	R _{GE} = 20 kΩ	1200			V
I _C	T _{case} = 25/80 °C	100 / 90			A
I _{CM}	T _{case} = 25/80 °C; t _p = 1 ms	200 / 180			A
V _{GES}		± 20			V
P _{tot}	per IGBT/D1/D8, T _{case} =25 °C	690 / 125 / 125			W
T _j , (T _{stg})		- 40 ... +150 (125)			°C
V _{isol}	AC, 1 min.	2 500			V
humidity	DIN 40 040	Class F			
climate	DIN IEC 68 T.1	40/125/56			
Diodes ⁹⁾		D1-6	D7	D8	
I _F	T _{case} = 80 °C	⁹⁾	30	30	A
I _{FM} = - I _{CM}	T _{case} = 80 °C; t _p = 1 ms		60	60	A
I _{FSM}	t _p = 10 ms; sin.; T _j = 150 °C	720	350	350	A
I ² t	t _p = 10 ms; T _j = 150 °C	2600	600	600	A ² s

SEMITRANS® M IGBT Modules SKD 100 GAL 123 D Input bridge B6U with brake chopper

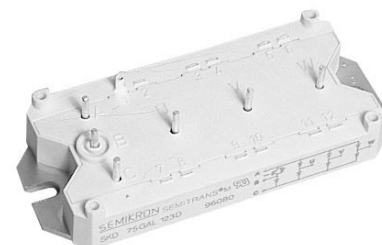

7D-Pack = 7 Diodes Pack

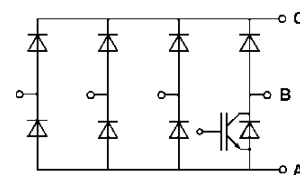

SKD 100 GAL

Features

- Round main terminals (2 mm Ø)
- Easy drilling of PCB
- Input diodes glass passivated
- 1400 V PIV
- High I²t rating (inrush current)
- IGBT is latch-up free, homogeneous NPT silicon-structure
- High short circuit capability, self limiting to 6 * I_{cnom}⁸⁾
- Fast & soft CAL diodes⁸⁾
- Isolated copper baseplate using DCB Direct Copper Bonding Technology
- Large clearance (9 mm) and creepage distances (13 mm).

Typical Applications:

Input rectifier bridge (B6U) with brake chopper for PWM inverter drives using SEMITRANS SKM 75GD123D

Characteristics		min. typ. max.			Units
Symbol	Conditions ¹⁾				
V _{(BR)CES}	V _{GE} = 0, I _C = 4 mA	≥ V _{CES}	-	-	V
V _{GE(th)}	V _{GE} = V _{CE} , I _C = 2 mA	4,5	5,5	6,5	V
I _{CES}	V _{GE} = 0 } T _j = 25 °C	-	0,8	1,5	mA
	V _{CE} = V _{CES} } T _j = 125 °C	-	6	-	mA
I _{GES}	V _{GE} = 20 V, V _{CE} = 0	-	-	300	nA
V _{CEsat}	I _C = 75 A } V _{GE} = 15 V;	-	2,5(3,1)	3(3,7)	V
V _{CEsat}	I _C = 100 A } T _j = 25 (125) °C }	-	2,8(3,6)	-	V
g _{fs}	V _{CE} = 20 V, I _C = 75 A	31	-	-	S
C _{CHC}	per IGBT	-	-	350	pF
C _{ies}	V _{GE} = 0	-	5	6,6	nF
C _{oes}	V _{CE} = 25 V	-	720	900	pF
C _{res}	f = 1 MHz	-	380	500	pF
t _{d(on)}	V _{CC} = 600 V	-	30	60	ns
t _r	V _{GE} = + 15 V / - 15 V ³⁾	-	70	140	ns
t _{d(off)}	I _C = 75 A, ind. load	-	450	600	ns
t _f	R _{Gon} = R _{Goff} = 15 Ω	-	70	100	ns
E _{on}	T _j = 125 °C	-	10	-	mWs
E _{off}		-	8	-	mWs
Inverse Diode D7 ⁸⁾ of brake chopper					
V _F = V _{EC}	I _F = 25 A } V _{GE} = 0 V;	-	2,0(1,8)	2,5	V
V _F = V _{EC}	I _F = 40 A } T _j = 25 (125) °C }	-	2,2(2,1)	-	V
V _{TO}	T _j = 125 °C	-	1,1	1,2	V
r _T	T _j = 125 °C	-	25	44	mΩ
I _{RRM}	I _F = 25 A; T _j = 25 (125) °C ²⁾	-	(25)	-	A
Q _{rr}	I _F = 25 A; T _j = 25 (125) °C ²⁾	-	2(4,5)	-	μC
FWD D8 of "GAL" brake chopper ⁸⁾					
V _F = V _{EC}	I _F = 25 A } V _{GE} = 0 V;	-	2,0 (1,8)	2,5	V
V _F = V _{EC}	I _F = 40 A } T _j = 25 (125) °C }	-	2,3 (2,1)	-	V
V _{TO}	T _j = 125 °C	-	-	1,2	V
r _T	T _j = 125 °C	-	25	44	mΩ
I _{RRM}	I _F = 25 A; T _j = 25 (125) °C ²⁾	-	19(25)	-	A
Q _{rr}	I _F = 25 A; T _j = 25 (125) °C ²⁾	-	1,5(4,5)	-	μC
Thermal Characteristics					
R _{thjc}	per IGBT / diode D1..6 ⁹⁾	-	-	0,18 / 1	°C/W
R _{thjc}	per diode D7 / D8	-	-	1,0 / 1,0	°C/W
R _{thch}	per module / diode; IGBT	-	-	0,05 / 0,4	°C/W

¹⁾ T_{case} = 25 °C, unless otherwise specified

²⁾ I_F = - I_C, V_R = 600 V, - di_F/dt = 800 A/μs, V_{GE} = 0 V

³⁾ Use V_{GEoff} = -5 ... - 15 V

⁸⁾ CAL = Controlled Axial Lifetime Technology.

⁹⁾ Data D1 - D6, case and mech. data → B 6 - 232

SEMITRANS

7D-Pack = Seven Diodes Pack
(Sixpack modified)

Case D 69 A

CASED69A

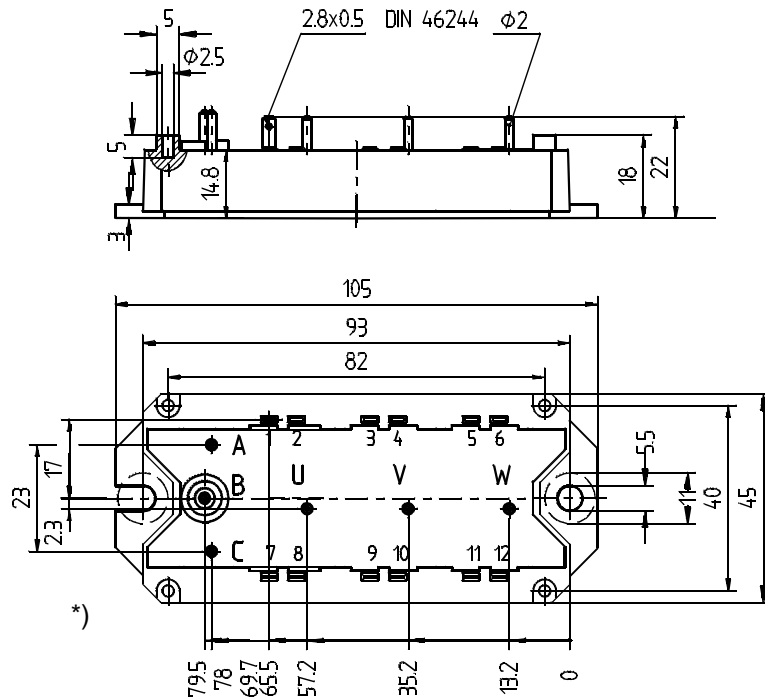

*) Plastic collar around pin B for UL creepage distance of > 12,7 mm

GCIGDAL

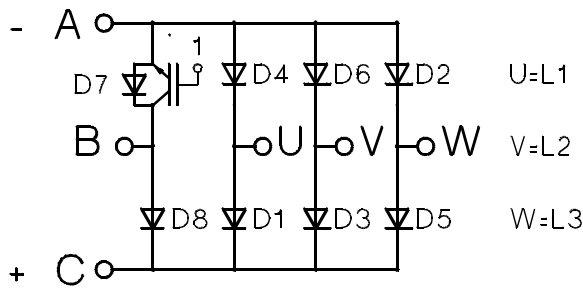

Dimensions in mm

Case outline and circuit diagram

Characteristics <small>continued</small>		Values			Units
Symbol	Conditions ¹⁾	min.	typ.	max.	
Input	Bridge Rectifier D1...D6				
V _{RRM}		1400	—	—	V
I _D	T _{case} = 80 °C;	—	—	100	A
V _F	T _{vj} = 25 °C; I _F = 75 A	—	—	1,45	V
V _{TO}	T _{vj} = 150 °C	—	—	0,8	V
r _T	T _{vj} = 150 °C	—	—	8,5	mΩ
R _{thjc}	D1...D6	—	—	1,0	K/W
T _{solder}	> 5 s, max. 15 sec. (transfer)	—	180	250	°C
Mechanical Data					
M1	to heatsink, SI Units (M5)	4	—	5	Nm
	to heatsink, US Units	35	—	44	lb.in.
a		—	—	5x9,81	m/s ²
w		—	—	175	g

This is an electrostatic discharge sensitive device (ESD). Please observe the international standard IEC 747-1, Chapter IX.

Two devices are supplied in one SEMIBOX A without mounting hardware. Larger Packing units (≥ 10) are used if suitable. SEMIBOX → C - 1.

For the IGBT use diagrams of type SKM 100 GB 123 D → B 6 - 112 etc.

For diodes D7/D8 use diode diagrams of type SKM 40 GD 123 D, → B 6 - 72

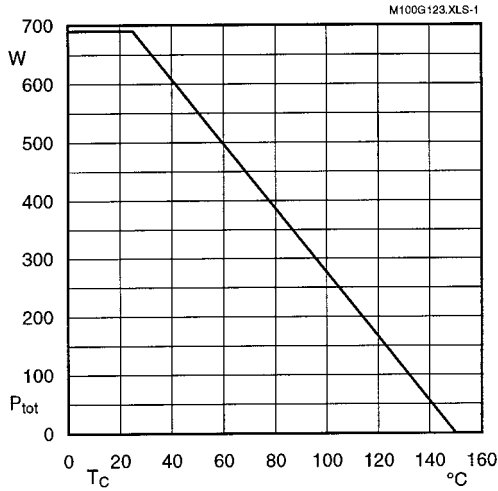

Fig. 1 Rated power dissipation $P_{tot} = f(T_C)$

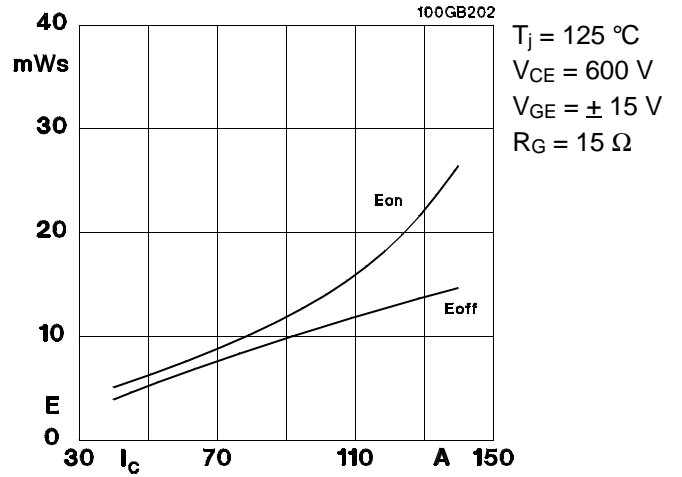

Fig. 2 Turn-on /-off energy $= f(I_C)$

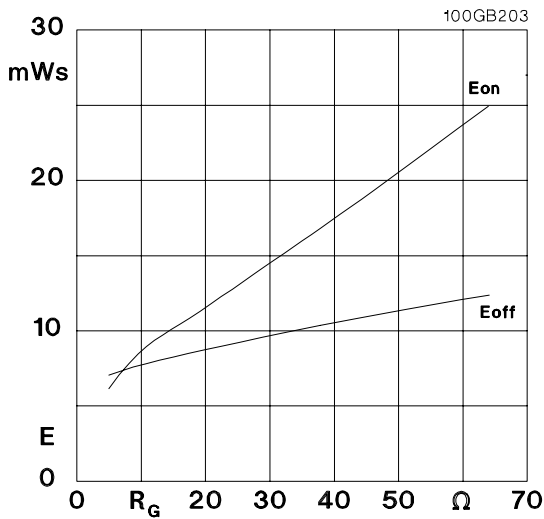

Fig. 3 Turn-on /-off energy $= f(R_G)$

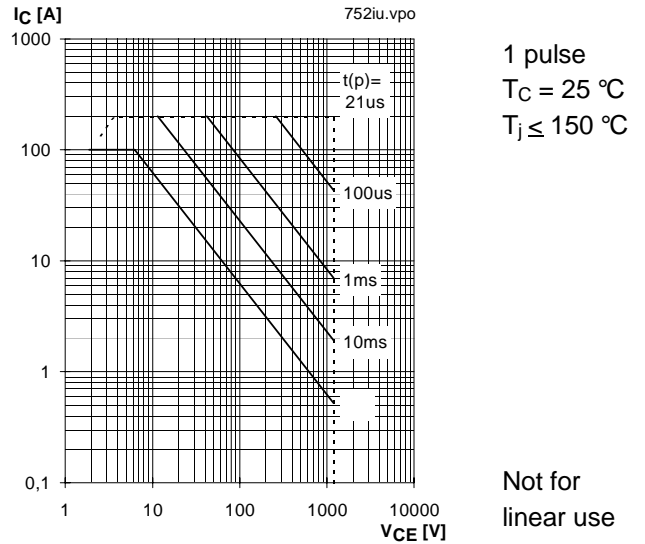

Fig. 4 Maximum safe operating area (SOA) $I_C = f(V_{CE})$

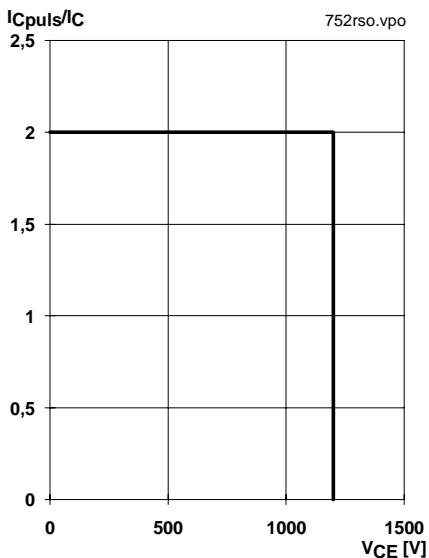

Fig. 5 Turn-off safe operating area (RBSOA)

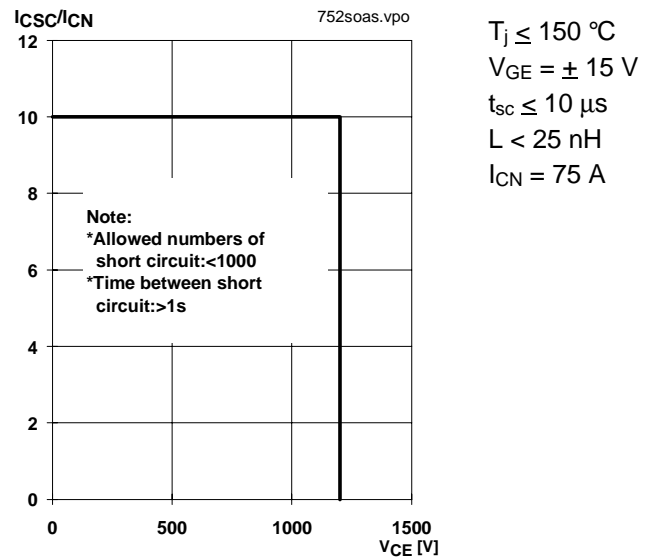

Fig. 6 Safe operating area at short circuit $I_C = f(V_{CE})$

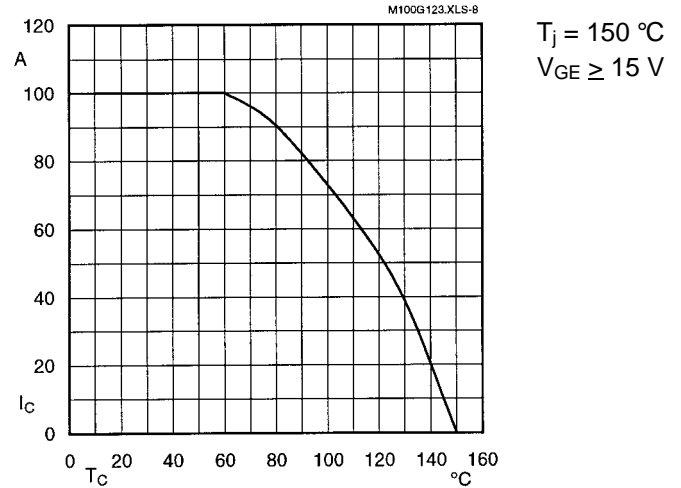

Fig. 8 Rated current vs. temperature $I_C = f(T_C)$

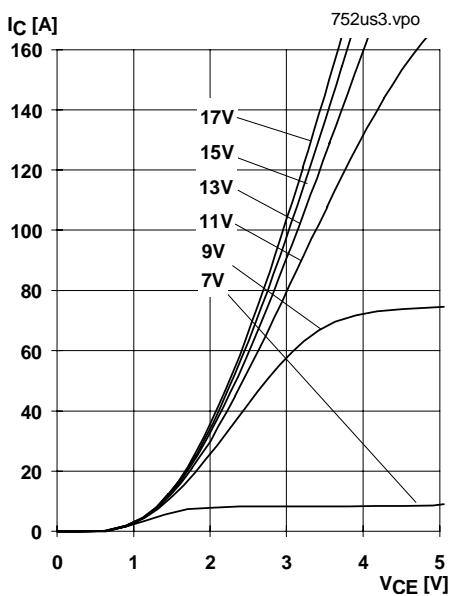

Fig. 9 Typ. output characteristic, $t_p = 80\text{ }\mu\text{s}$; $25\text{ }^\circ\text{C}$

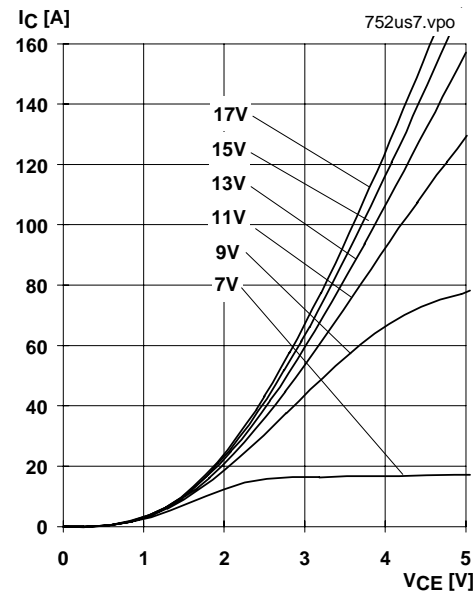

Fig. 10 Typ. output characteristic, $t_p = 80\text{ }\mu\text{s}$; $125\text{ }^\circ\text{C}$

$$P_{\text{cond}(t)} = V_{\text{CEsat}(t)} \cdot I_{\text{C}(t)}$$

$$V_{\text{CEsat}(t)} = V_{\text{CE(TO)(Tj)}} + r_{\text{CE(Tj)}} \cdot I_{\text{C}(t)}$$

$$V_{\text{CE(TO)(Tj)}} \leq 1,5 + 0,002 (T_j - 25) \text{ [V]}$$

$$\text{typ.: } r_{\text{CE(Tj)}} = 0,013 + 0,00005 (T_j - 25) \text{ [\Omega]}$$

$$\text{max.: } r_{\text{CE(Tj)}} = 0,020 + 0,00007 (T_j - 25) \text{ [\Omega]}$$

$$\text{valid for } V_{\text{GE}} = +15 \frac{+2}{-1} \text{ [V]; } I_{\text{C}} > 0,3 I_{\text{Cnom}}$$

Fig. 11 Saturation characteristic (IGBT)
Calculation elements and equations

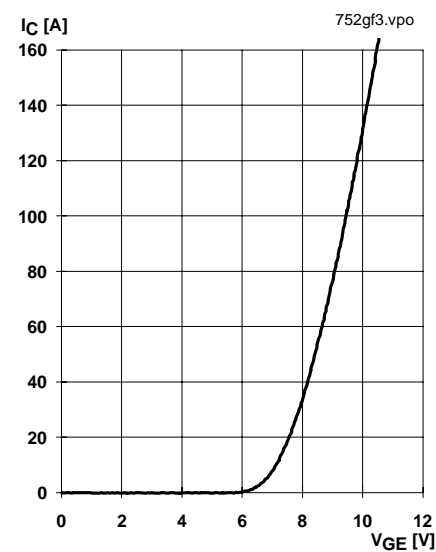

Fig. 12 Typ. transfer characteristic, $t_p = 80\text{ }\mu\text{s}$; $V_{\text{CE}} = 20\text{ V}$

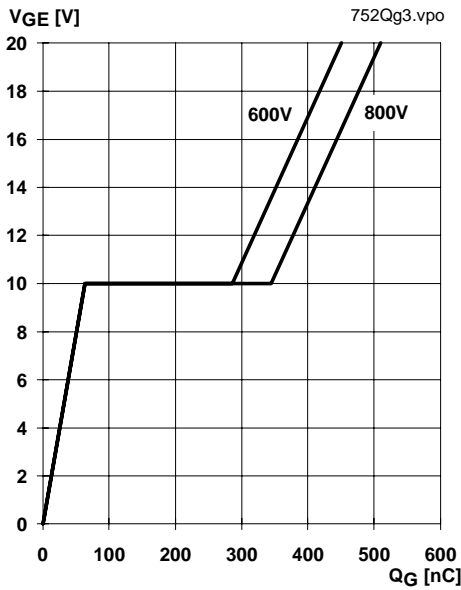
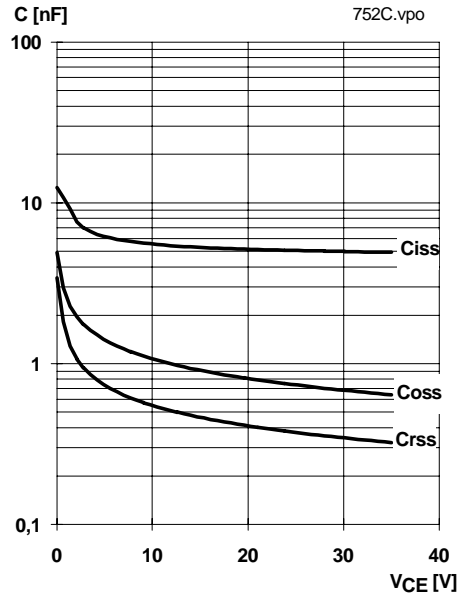

Fig. 13 Typ. gate charge characteristic

$I_{Cpuls} = 75 \text{ A}$



$V_{GE} = 0 \text{ V}$
 $f = 1 \text{ MHz}$

Fig. 14 Typ. capacitances vs. V_{CE}

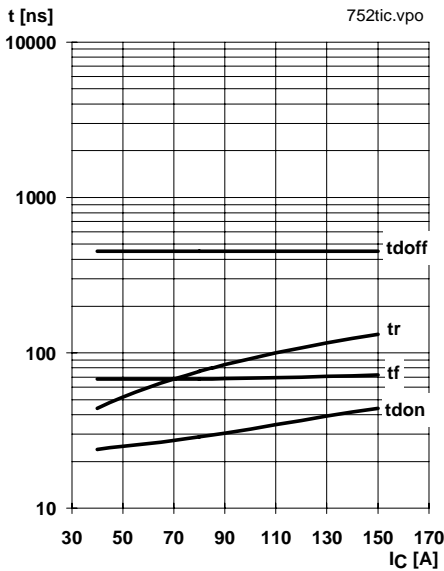
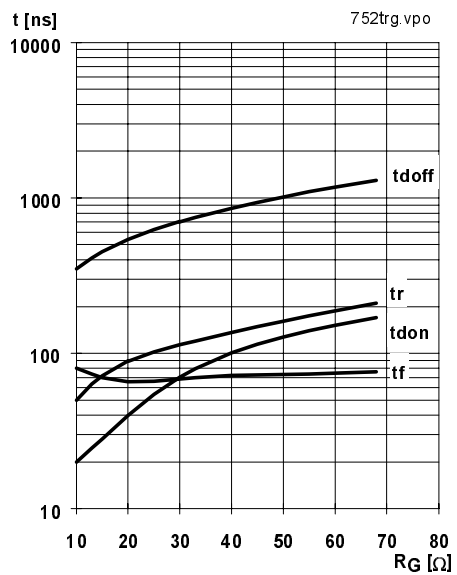

Fig. 15 Typ. switching times vs. I_C

$T_j = 125 \text{ }^\circ\text{C}$
 $V_{CE} = 600 \text{ V}$
 $V_{GE} = \pm 15 \text{ V}$
 $R_{Gon} = 15 \text{ } \Omega$
 $R_{Goff} = 15 \text{ } \Omega$
induct. load



$T_j = 125 \text{ }^\circ\text{C}$
 $V_{CE} = 600 \text{ V}$
 $V_{GE} = \pm 15 \text{ V}$
 $I_C = 75 \text{ A}$
induct. load

Fig. 16 Typ. switching times vs. gate resistor R_G

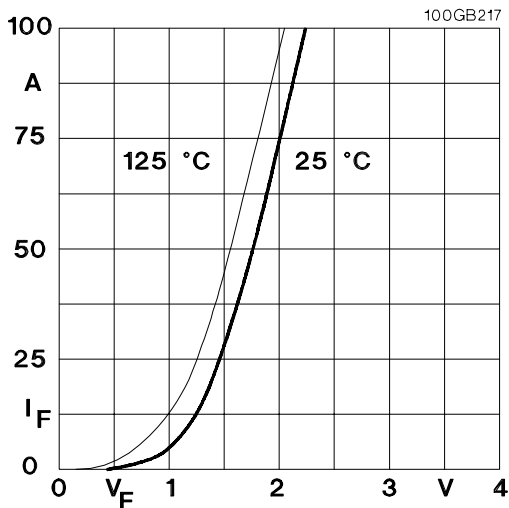

Fig. 17 Typ. CAL diode forward characteristic

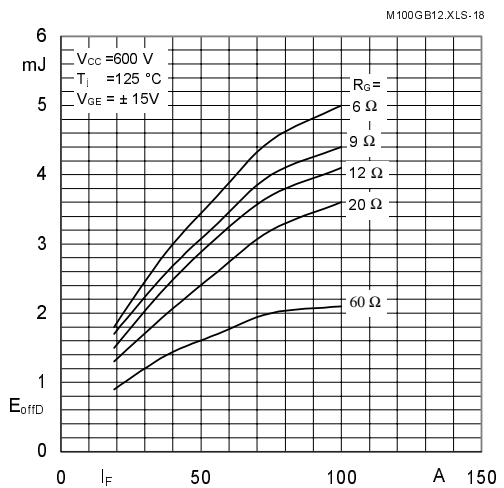

Fig. 18 Diode turn-off energy dissipation per pulse

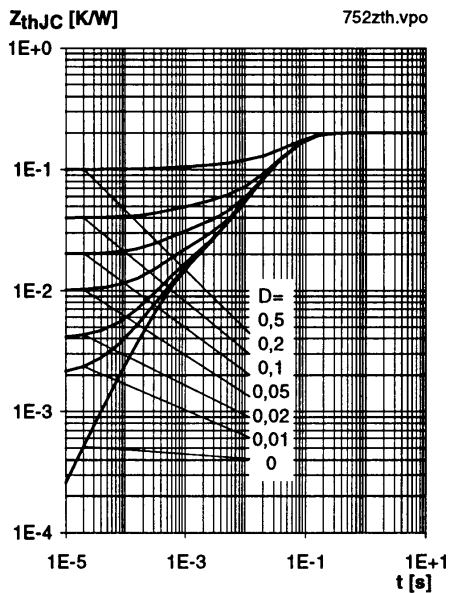

Fig. 19 Transient thermal impedance of IGBT
 $Z_{thJC} = f(t_p)$; $D = t_p / t_c = t_p \cdot f$

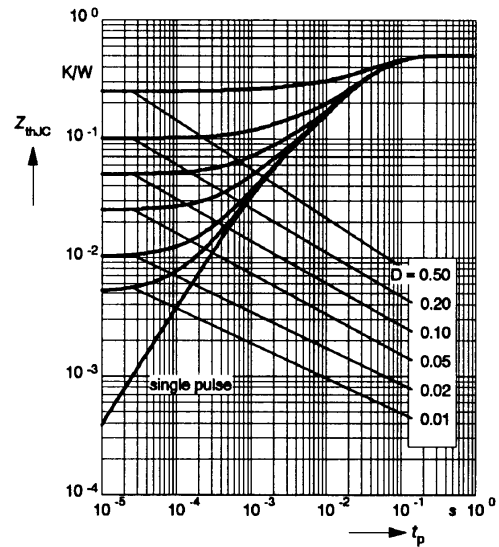

Fig. 20 Transient thermal impedance of inverse CAL diodes
 $Z_{thJC} = f(t_p)$; $D = t_p / t_c = t_p \cdot f$

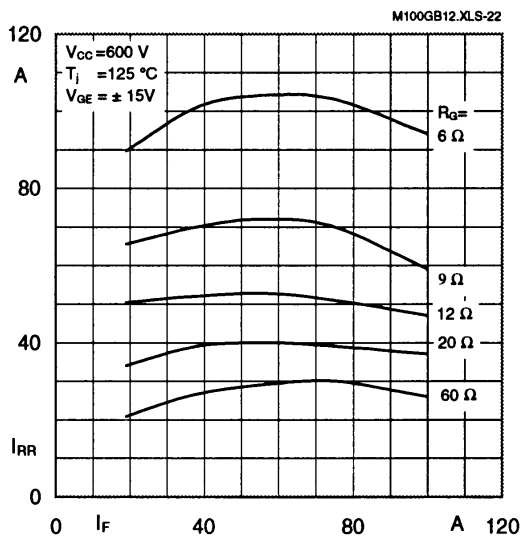

Fig. 22 Typ. CAL diode peak reverse recovery current $I_{RR} = f(I_F; R_G)$

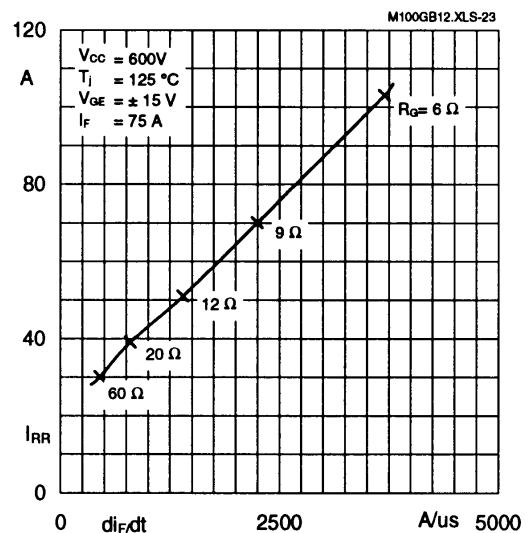

Fig. 23 Typ. CAL diode peak reverse recovery current $I_{RR} = f(di_F/dt)$

Typical Applications

include

- Switched mode power supplies
- DC servo and robot drives
- Inverters
- DC choppers (versions GAR; GAL)
- AC motor speed control
- Inductive heating
- UPS Uninterruptable power supplies
- General power switching applications
- Electronic (also portable) welders
- Pulse frequencies also above 15 kHz

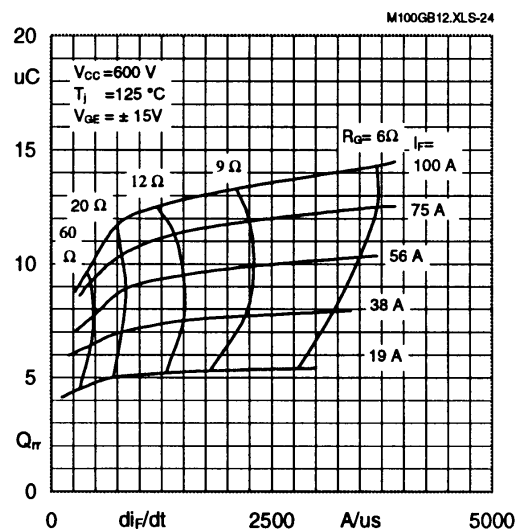

Fig. 24 Typ. CAL diode recovered charge $Q_{rr} = f(di/dt)$