

SKM 400GB126D

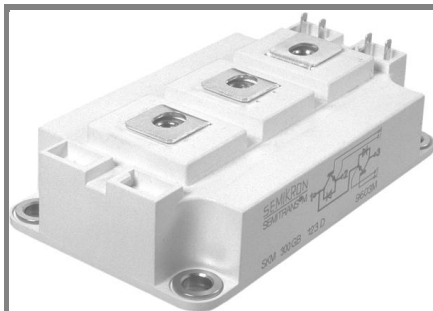

SEMITRANS™ 3

Trench IGBT Module

SKM 400GB126D

Preliminary Data

Features

- Homogeneous Si
- Trench = Trenchgate technology
- $V_{CE(sat)}$ with positive temperature coefficient
- High short circuit capability, self limiting to $6 \times I_C$

Typical Applications

- AC inverter drives
- UPS
- Electronic welders

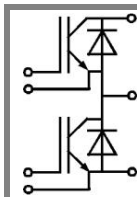

GB

Absolute Maximum Ratings		$T_C = 25\text{ }^\circ\text{C}$, unless otherwise specified	
Symbol	Conditions	Values	Units
IGBT			
V_{CES}		1200	V
I_C	$T_{case} = 25\text{ (80) }^\circ\text{C}$	470 (330)	A
I_{CRM}	$T_{case} = 25\text{ (80) }^\circ\text{C}$, $t_p = 1\text{ ms}$	940 (660)	A
V_{GES}		± 20	V
T_{vj} (T_{stg})	$T_{OPERATION} \leq T_{stg}$	- 40 ... + 150 (125)	$^\circ\text{C}$
V_{isol}	AC, 1 min.	4000	V
Inverse diode			
$I_F = -I_C$	$T_{case} = 25\text{ (80) }^\circ\text{C}$	400 (270)	A
I_{FRM}	$T_{case} = 25\text{ (80) }^\circ\text{C}$, $t_p \leq 1\text{ ms}$	940 (660)	A
I_{FSM}	$t_p = 10\text{ ms}$; sin.; $T_j = 150\text{ }^\circ\text{C}$		A
Freewheeling diode			
$I_F = -I_C$	$T_{case} = \text{ }^\circ\text{C}$		A
I_{FRM}	$T_{case} = (\text{ })\text{ }^\circ\text{C}$, $t_p < \text{ms}$		A
I_{FSM}	$t_p = \text{ms}$; ; $T_j = \text{ }^\circ\text{C}$		A

Characteristics		$T_C = 25\text{ }^\circ\text{C}$, unless otherwise specified			
Symbol	Conditions	min.	typ.	max.	Units
IGBT					
$V_{GE(th)}$	$V_{GE} = V_{CE}$, $I_C = 12\text{ mA}$	5	5,8	6,5	V
I_{CES}	$V_{GE} = 0$, $V_{CE} = V_{CES}$, $T_j = 25\text{ (125) }^\circ\text{C}$			2	mA
$V_{CE(TO)}$	$T_j = 25\text{ (125) }^\circ\text{C}$		1 (0,9)	1,2	V
r_{CE}	$V_{GE} = 15\text{ V}$, $T_j = 25\text{ (125) }^\circ\text{C}$		2,3 (3,7)	3,2	m Ω
$V_{CE(sat)}$	$I_C = 300\text{ A}$, $V_{GE} = 15\text{ V}$, chip level		1,7 (2)	2,15	V
C_{ies}	under following conditions		23,1		nF
C_{oes}	$V_{GE} = 0$, $V_{CE} = 25\text{ V}$, $f = 1\text{ MHz}$		1,9		nF
C_{res}			1,2		nF
L_{CE}				20	nH
$R_{CC'+EE'}$	resistance, terminal-chip $T_c = 25\text{ (125) }^\circ\text{C}$		0,35 (0,5)		m Ω
$t_{d(on)}$	$V_{CC} = 600\text{ V}$, $I_C = 300\text{ A}$		330		ns
t_r	$R_{Gon} = R_{Goff} = 2\text{ }^\circ\Omega$, $T_j = 125\text{ }^\circ\text{C}$		50		ns
$t_{d(off)}$	$V_{GE} \pm 15\text{ V}$		650		ns
t_f			110		ns
$E_{on} (E_{off})$			29 (48)		mJ
Inverse diode					
$V_F = V_{EC}$	$I_F = 300\text{ A}$; $V_{GE} = 0\text{ V}$; $T_j = 25\text{ (125) }^\circ\text{C}$		1,6 (1,7)	1,8	V
$V_{T(TO)}$	$T_j = 25\text{ (125) }^\circ\text{C}$		1 (0,8)	1,1	V
r_T	$T_j = 25\text{ (125) }^\circ\text{C}$		2 (2,7)	2,3	m Ω
I_{RRM}	$I_F = 300\text{ A}$; $T_j = 125\text{ () }^\circ\text{C}$		390		A
Q_{rr}	$di/dt = 6300\text{ A}/\mu\text{s}$		77		μC
E_{rr}	$V_{GE} = 0\text{ V}$		32		mJ
FWD					
$V_F = V_{EC}$	$I_F = \text{A}$; $V_{GE} = \text{V}$, $T_j = (\text{ })\text{ }^\circ\text{C}$				V
V_{TO}	$T_j = (\text{ })\text{ }^\circ\text{C}$				V
r_T	$T_j = (\text{ })\text{ }^\circ\text{C}$				m Ω
I_{RRM}	$I_F = \text{A}$; $T_j = (\text{ })\text{ }^\circ\text{C}$				A
Q_{rr}	$V_{GE} = \text{V}$				μC
E_{rr}					mJ
Thermal characteristics					
$R_{th(j-c)}$	per IGBT			0,08	K/W
$R_{th(j-c)D}$	per Inverse Diode			0,18	K/W
$R_{th(j-c)FD}$	per FWD				K/W
$R_{th(c-s)}$	per module			0,038	K/W
Mechanical data					
M_s	to heatsink (M6)	3		5	Nm
M_t	for terminals (M5)	2,5		5	Nm
w				325	g

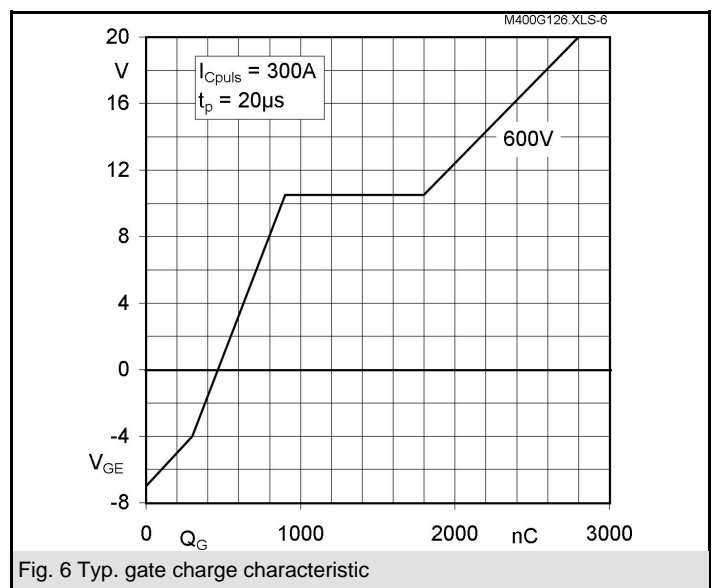
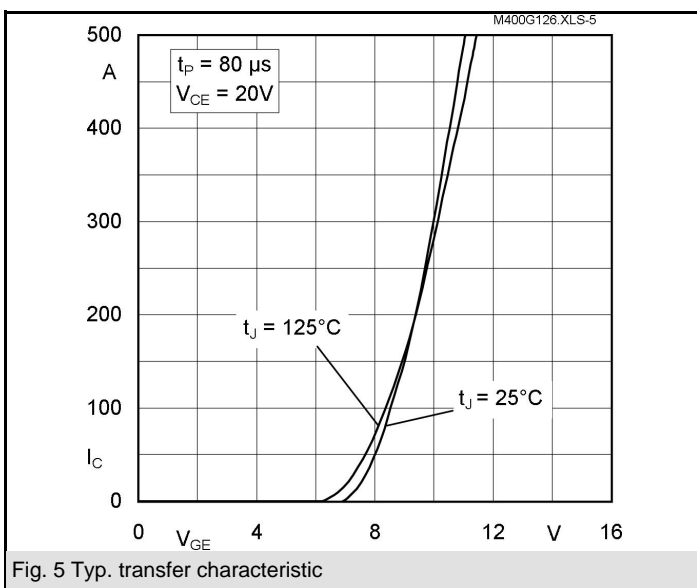
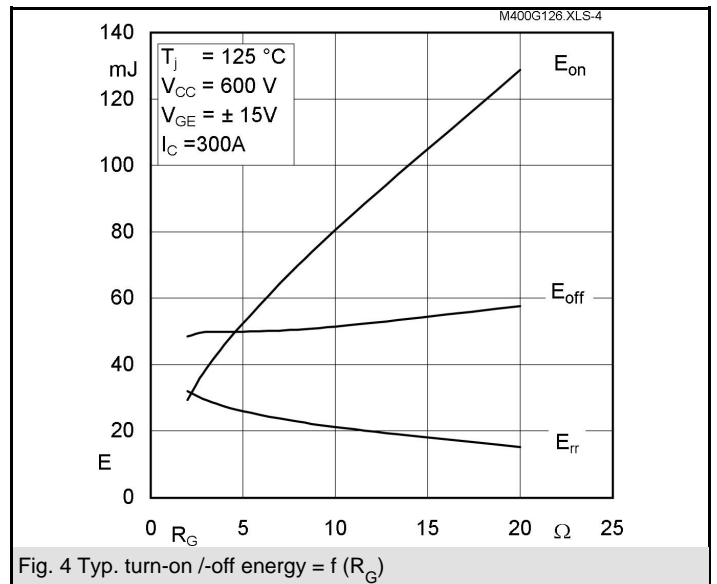
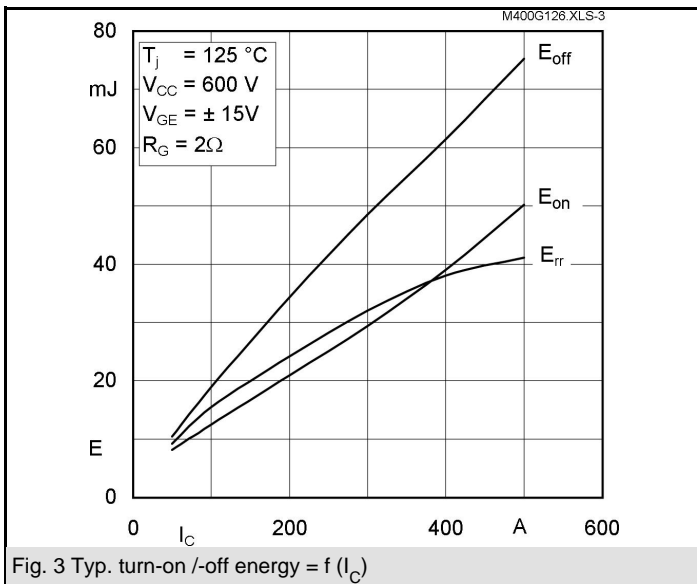
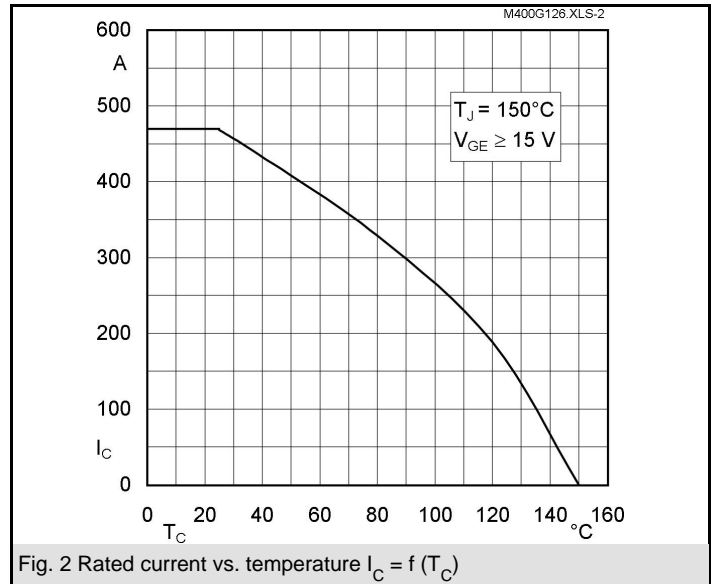
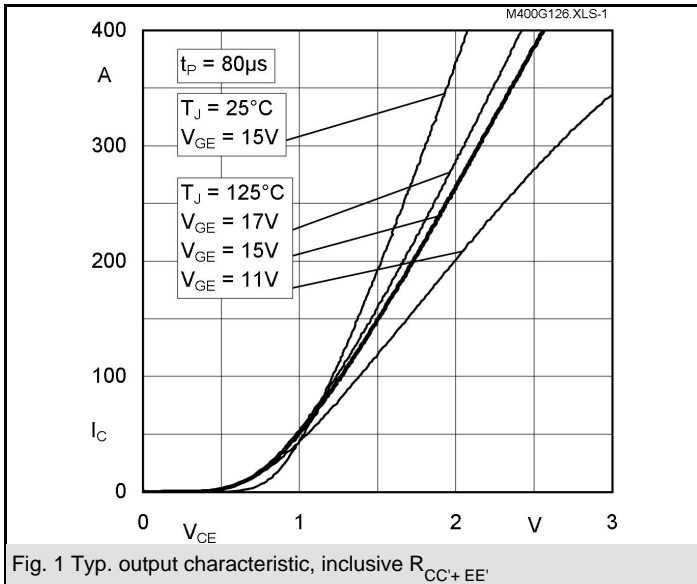

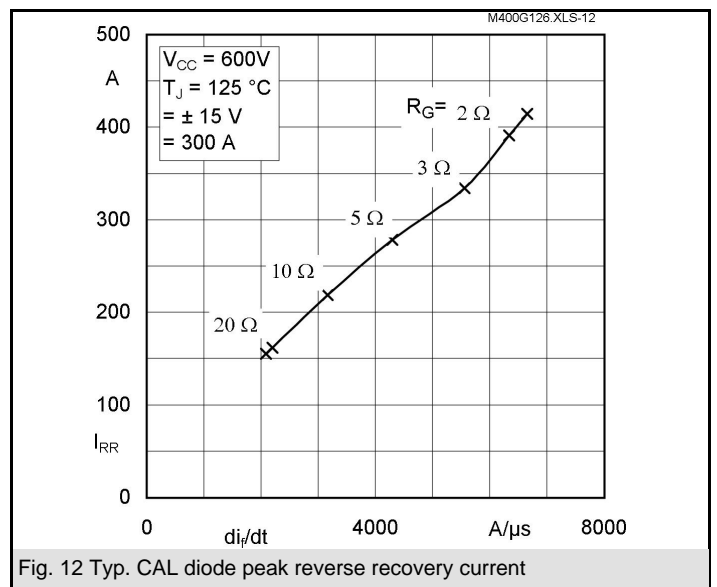
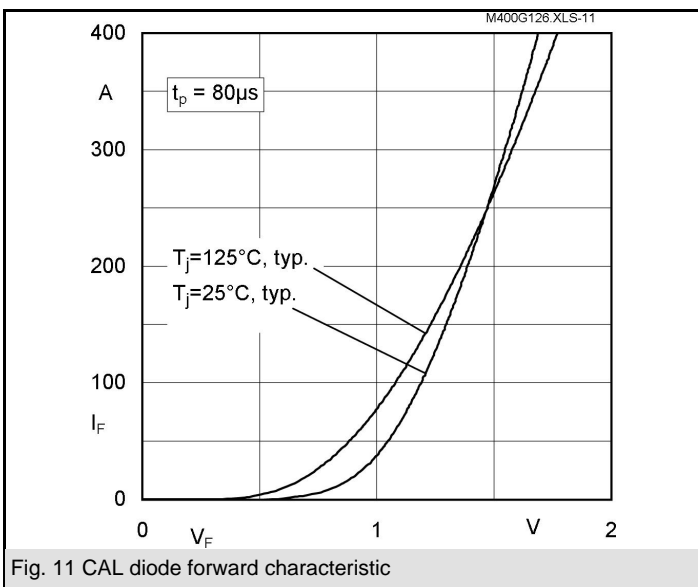
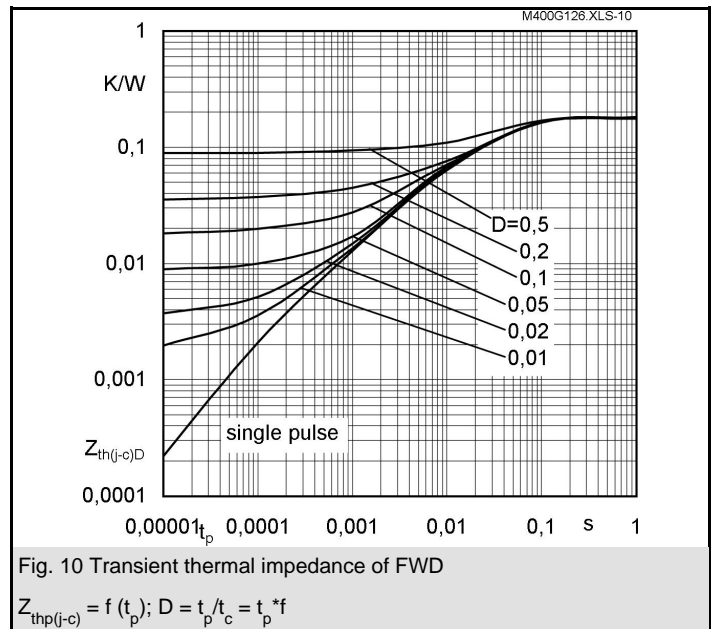
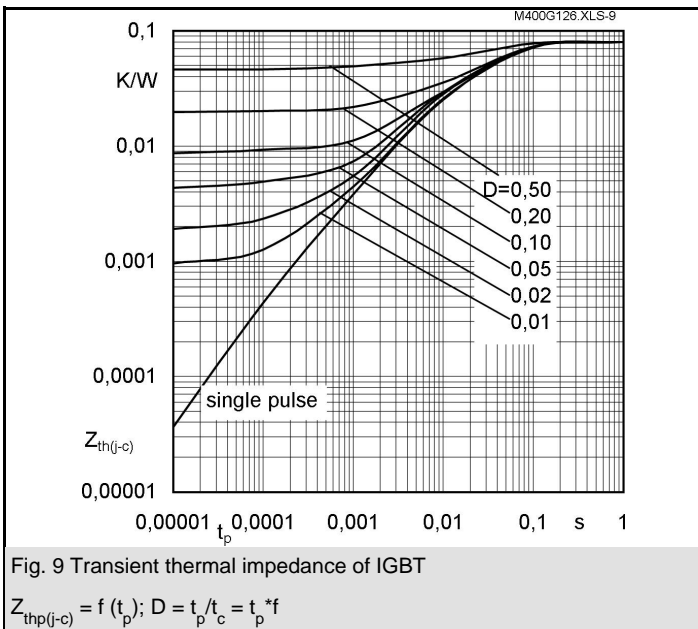
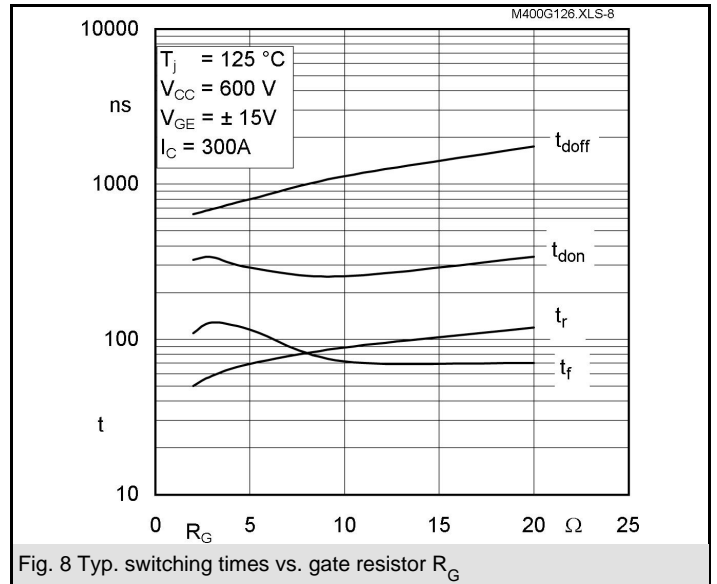
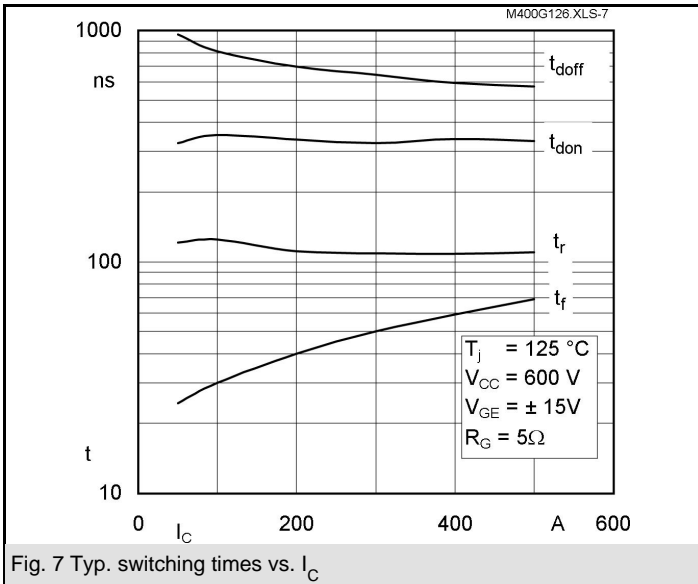

SKM 400GB126D

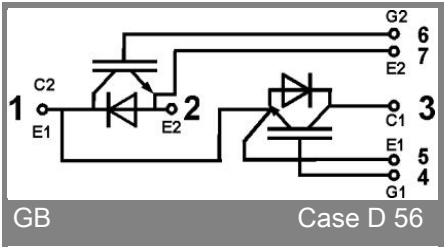
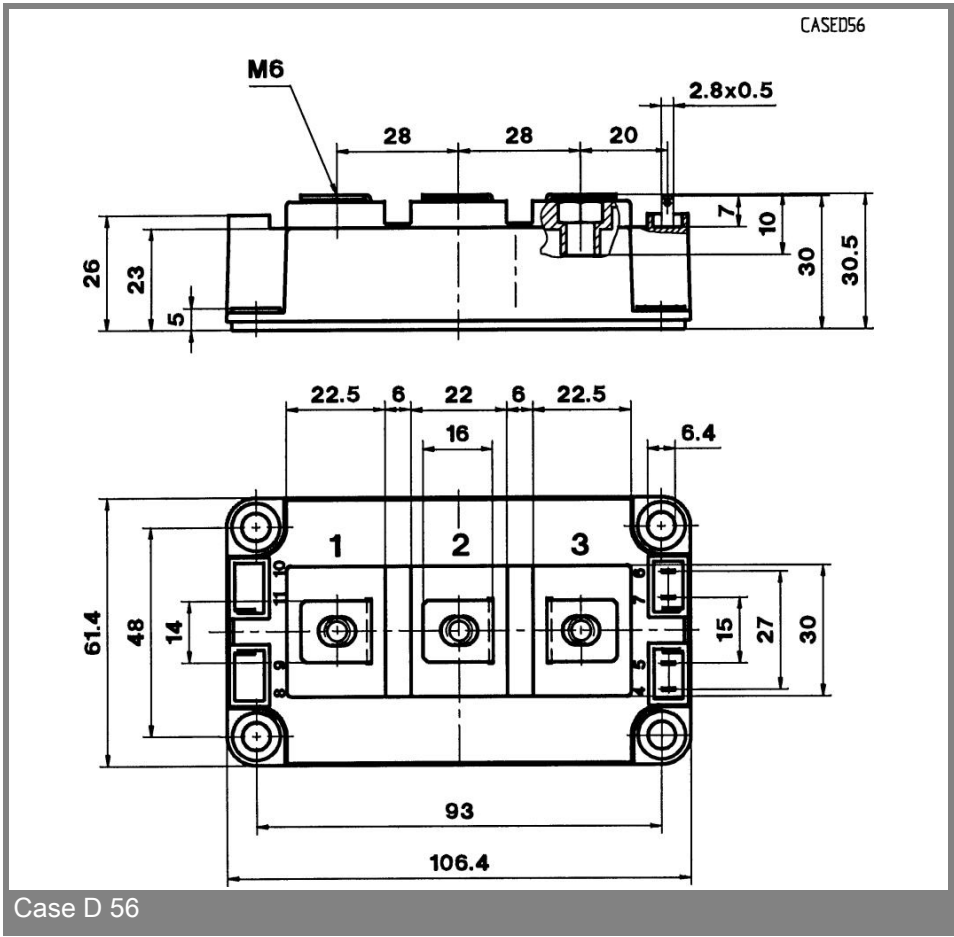
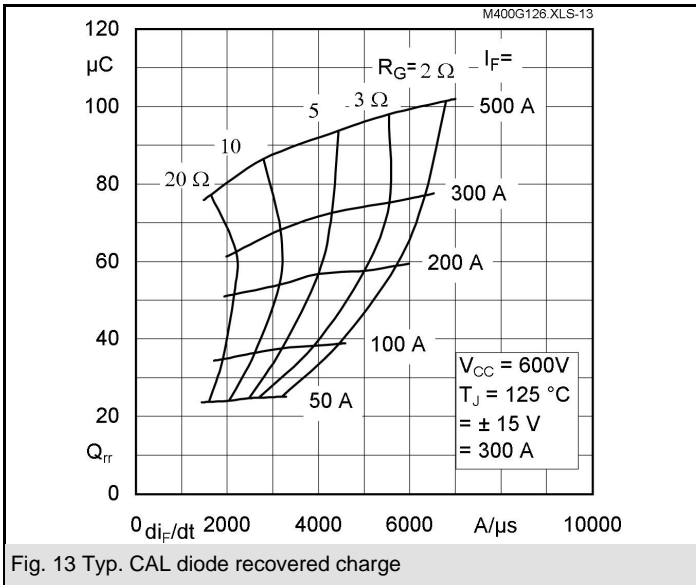

This is an electrostatic discharge sensitive device (ESDS), international standard IEC 60747-1, Chapter IX.

This technical information specifies semiconductor devices but promises no characteristics. No warranty or guarantee expressed or implied is made regarding delivery, performance or suitability.