

PNP Silicon Darlington Transistors

- High collector current
- High DC current gain

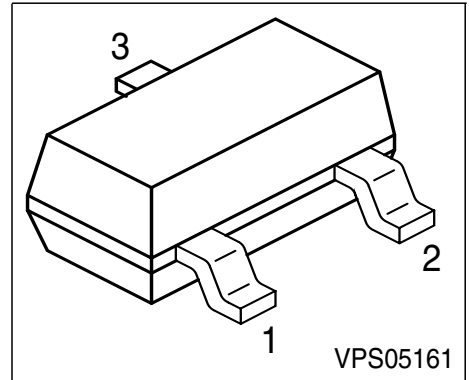

Type	Marking	Pin Configuration			Package
SMBTA 63	s2U	1 = B	2 = E	3 = C	SOT-23
SMBTA 64	s2V	1 = B	2 = E	3 = C	SOT-23

Maximum Ratings

Parameter	Symbol	Value	Unit
Collector-emitter voltage	V_{CES}	30	V
Collector-base voltage	V_{CBO}	30	
Emitter-base voltage	V_{EBO}	10	
DC collector current	I_C	500	mA
Peak collector current	I_{CM}	800	A
Base current	I_B	100	mA
Peak base current	I_{BM}	200	
Total power dissipation, $T_S = 81\text{ °C}$	P_{tot}	360	mW
Junction temperature	T_j	150	°C
Storage temperature	T_{stg}	-65 ... 150	

Thermal Resistance

Junction ambient ¹⁾	R_{thJA}	≤280	K/W
Junction - soldering point	R_{thJS}	≤210	

1) Package mounted on pcb 40mm x 40mm x 1.5mm / 6cm² Cu

Electrical Characteristics at $T_A = 25^\circ\text{C}$, unless otherwise specified.

Parameter	Symbol	Values			Unit
		min.	typ.	max.	
DC Characteristics					
Collector-emitter breakdown voltage $I_C = 10 \mu\text{A}$, $V_{BE} = 0$	$V_{(BR)CES}$	30	-	-	V
Collector-base breakdown voltage $I_C = 10 \mu\text{A}$, $I_B = 0$	$V_{(BR)CBO}$	30	-	-	
Emitter-base breakdown voltage $I_E = 10 \mu\text{A}$, $I_C = 0$	$V_{(BR)EBO}$	10	-	-	
Collector cutoff current $V_{CB} = 30 \text{ V}$, $I_E = 0$	I_{CBO}	-	-	100	nA
Collector cutoff current $V_{CB} = 30 \text{ V}$, $I_E = 0$, $T_A = 150^\circ\text{C}$	I_{CBO}	-	-	10	μA
Emitter cutoff current $V_{EB} = 10 \text{ V}$, $I_C = 0$	I_{EBO}	-	-	100	nA
DC current gain 1) $I_C = 10 \text{ mA}$, $V_{CE} = 5 \text{ V}$ $I_C = 100 \text{ mA}$, $V_{CE} = 5 \text{ V}$	h_{FE}				-
	SMBTA 63	5000	-	-	
	SMBTA 64	10000	-	-	
	SMBTA 63	10000	-	-	
	SMBTA 64	20000	-	-	
Collector-emitter saturation voltage1) $I_C = 100 \text{ mA}$, $I_B = 0.1 \text{ mA}$	V_{CEsat}	-	-	1.5	V
Base-emitter saturation voltage 1) $I_C = 100 \text{ mA}$, $I_B = 0.1 \text{ mA}$	V_{BEsat}	-	-	2	
AC Characteristics					
Transition frequency $I_C = 50 \text{ mA}$, $V_{CE} = 5 \text{ V}$, $f = 20 \text{ MHz}$	f_T	125	-	-	MHz

1) Pulse test: $t \leq 300 \mu\text{s}$, $D = 2\%$

Total power dissipation $P_{tot} = f(T_A^*; T_S)$

* Package mounted on epoxy

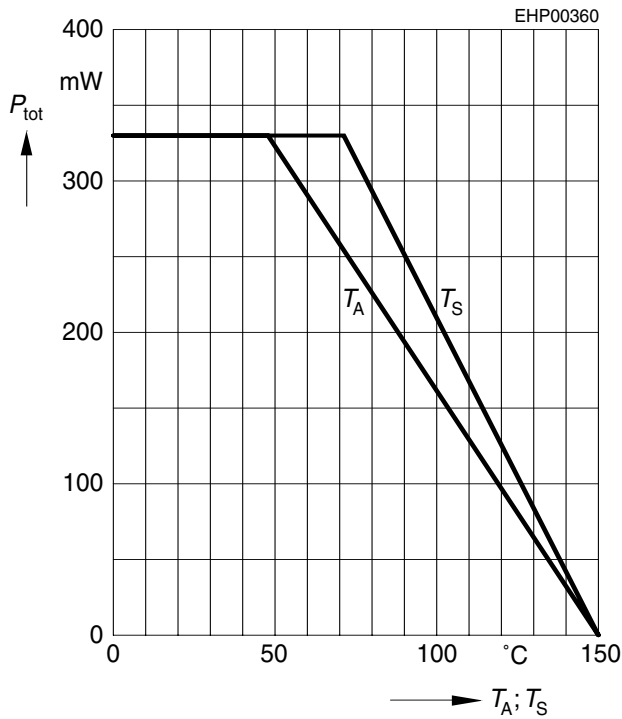

Collector-base capacitance $C_{CB} = f(V_{CBO})$

Emitter-base capacitance $C_{EB} = f(V_{EBO})$

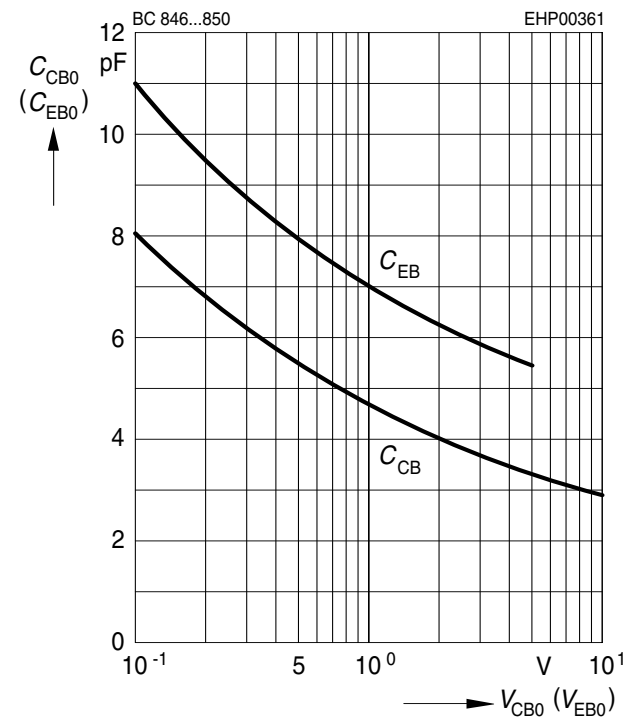

Permissible pulse load

$P_{totmax} / P_{totDC} = f(t_p)$

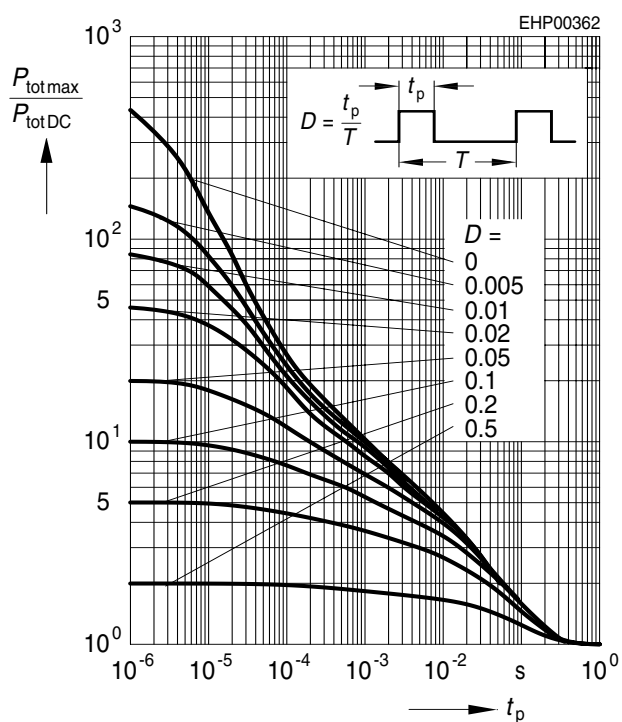

Transition frequency $f_T = f(I_C)$

$V_{CE} = 5V$

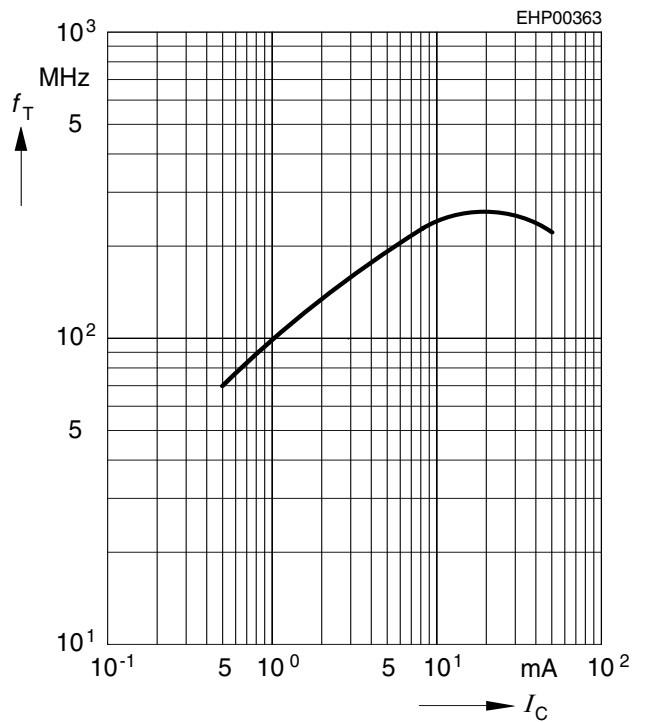

Base-emitter saturation voltage

$I_C = f(V_{BEsat}), h_{FE} = 20$

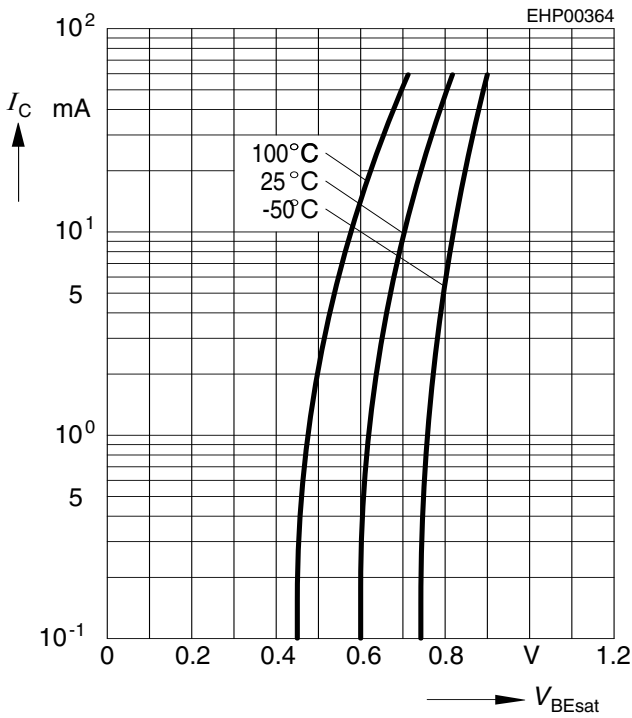

Collector-emitter saturation voltage

$I_C = f(V_{CEsat}), h_{FE} = 20$

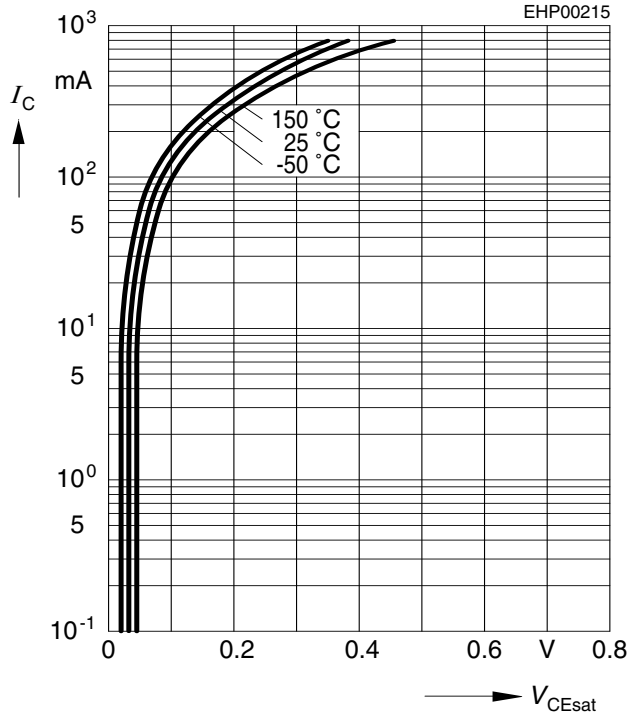

Collector cutoff current $I_{CBO} = f(T_A)$

$V_{CB} = 30V$

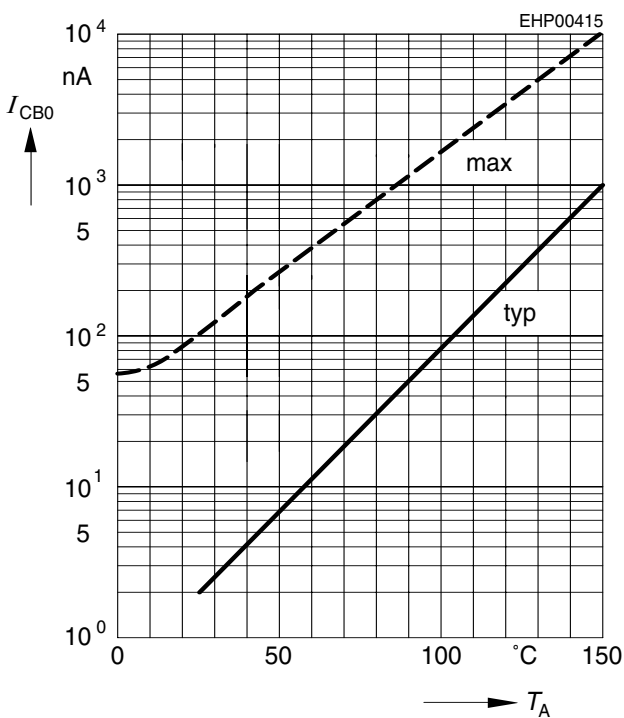

DC current gain $h_{FE} = f(I_C)$

$V_{CE} = 5V$

